



TECNICO

STYLE • INDOOR • OUTDOOR • FLEX.light

MOLTO LUCE®



MOLTO LUCE

Als **österreichischer Produzent und Gesamtanbieter für Lichtlösungen** mit mehr als 40 Jahren Erfahrung, gelingt es uns täglich, unsere Kunden mit maßgeschneiderten Beleuchtungskonzepten und einem Service mit Handschlag-Qualität zu begeistern. Unsere Leidenschaft für Licht wird durch herausragende Technik und modernstes Design vervollständigt.

Mit unserem „**People. Power. Planet.**“ Programm gehen wir über den sozialen Aspekt und den Umweltschutz hinaus. Wir setzen den Fokus ebenso darauf, dass unsere Produkte durch eine höchstmögliche Effizienz nicht nur **Energiekosten**, sondern auch **C02 sparen**.

As Austrian producer and single-source supplier for lighting solutions with more than 40 year of experience, we succeed on a daily basis to delight our customers with tailor-made lighting concepts and service with „Handshake-quality“. Our passion for light is completed through superior technology and state-of the art design.

With our „**People. Power. Planet. Programme.**“ we go beyond the social aspect and environmental protection. We also focus on ensuring that our products not only **save energy costs** but also **reduce C02** by maximising efficiency.



Jetzt Neu: Interaktivität im Katalog

Mit der Vision unseren Kunden mehr zu bieten, als es in einem gedruckten Katalog möglich ist, haben wir die **digitale** Version des TECNICO Katalogs mit spannenden, interaktiven Features ausgestattet. Die Wirkung einer Leuchte **per Knopfdruck** wahrnehmen und über die geschaffene Atmosphäre staunen. Lichtberechnungsdateien, Tageslichtrenderings, Farb- und Modellauswahl, Animationen uvm. machen es möglich.

„Wir haben den Unterschied **spürbar** gemacht. Mehr dazu auf moltoluce.com“

Now new: interactivity in the catalogue

With the aim of providing our customers with more than what is possible in a printed catalogue, we have equipped the digital version of the TECNICO catalogue with exciting interactive features. Experience the effect of a luminaire at the touch of a button and marvel at the atmosphere created. Light calculation files, daylight renderings, colour and model selection, animations and more enable it.

„We have made a noticeable difference. Learn more on moltoluce.com“.



TECNICO

Mit der diesjährigen Ausgabe des TECNICO Kataloges von Molto Luce, setzen wir neue Maßstäbe wenn es um Produkte für's **Daily Business** geht. Mit dem Ziel eine 100%ige Produkt-Verfügbarkeit zu gewährleisten, haben wir durch **lagernde Artikel** die Wartezeiten auf ein Minimum reduziert. „Auf Knopfdruck geliefert.“ Und das **innerhalb von 24h!** In unserem breiten und abwechslungsreichen Sortiment findet man neben dekorativen Produkten mit Fokus auf den **Private und Hospitality Bereich** auch **Outdoor** Produkte sowie **flexible LED** Streifen inkl. Aluminium Profile. Abgerundet wird diese Auswahl durch nützliche **Accessoires** wie Netzgeräte, Leuchtmittel und Controller, die beim individuellen Einsatz oder der Lichtsteuerung helfen.

With this year's edition of the TECNICO catalogue from MoltoLuce catalogue, we are setting new standards when it comes to products for daily business. With the aim of guaranteeing 100% product availability, we have reduced waiting times to a minimum by keeping items in stock. „Delivered at the touch of a button.“ And within 24 hours! In our wide and diverse assortment decorative products with focus on the private and hospitality sector, outdoor products and flexible outdoor products as well as flexible LED strips incl. aluminium profiles can be found. This selection is rounded off by useful accessories such as power supply units, light sources and controllers which help with customised use cases or lighting control.

Produktvielfalt für alle Anwendungsbereiche

Die Produktvielfalt von MOLTO LUCE kennt so gut wie keine Grenzen. Neben den Daily Business Produkten des TECNICO Katalogs bieten unser **Konfigurator** sowie unsere weiteren **Produktfolder- und Kataloge** eine große Auswahl an qualitativen Lichtlösungen für die individuellen Einsatzbereiche. Egal ob Industrie, Office, Retail oder Private Living – mit unseren Produkten liegt man immer richtig.

Product variety for all areas of application

MOLTO LUCE's product diversity knows virtually no bounds. In addition to the products listed in the TECNICO catalogue, our **configurator** and other **product folders** provide a wide selection of options for industries, offices, retail spaces, and private residences. MOLTO LUCE offers an extensive range of high-quality lighting solutions for various applications.

Our products are always the perfect choice.





STYLE

VUTO PD	S. 008/P. 008
MELLI F	S. 010/P. 010
MELLI SDI	S. 012/P. 012
MELLI SD	S. 012/P. 012
MEYJO T	S. 016/P. 016
MEYJO F	S. 016/P. 016
PERFORA M	S. 020/P. 020
PERFORA L	S. 020/P. 020
PERFORA PRO M	S. 022/P. 022
PERFORA PRO L	S. 022/P. 022
PERFORA PRO XL	S. 022/P. 022
NUUN SD	S. 024/P. 024
NUUN PD	S. 024/P. 024
GILO PD	S. 026/P. 026
MIMO T	S. 028/P. 028
MIMO F	S. 028/P. 028
MIMO DOUBLE F	S. 028/P. 028
EEDEN S T	S. 030/P. 030
EEDEN M T	S. 031/P. 031
EEDEN M F 1	S. 032/P. 032
EEDEN M F 2	S. 032/P. 032
EEDEN M PD	S. 033/P. 033

INDOOR

CHICCO ROUND R	S. 038/P. 038	QANA BOX 1 SD	S. 102/P. 102
IVY ROUND R	S. 038/P. 038	QANA BOX 2 SD	S. 102/P. 102
SUNRAY I/II/III/IV	S. 040/P. 040	MUSO ROUND SD	S. 106/P. 106
SPEAKER 1/2	S. 042/P. 042	MUSO ROUND SD SENSOR	S. 106/P. 106
ENERGY 2130/2180/2245	S. 042/P. 042	MUSO ROUND SD DALI	S. 106/P. 106
AGON FLAT	S. 044/P. 044	MUSO SQUARE SD	S. 108/P. 108
AGON ROUND	S. 045/P. 045	MUSO SQUARE SD SENSOR	S. 108/P. 108
SATOR	S. 046/P. 046	MUSO LINEAR SD	S. 110/P. 110
PONTOS ROUND	S. 046/P. 046	MUSO 120 LINEAR CCT DALI	S. 110/P. 110
KALIO ROUND	S. 047/P. 047	ALKOR 2 E27	S. 112/P. 112
ELIX MINI R	S. 048/P. 048	APUS E27	S. 112/P. 112
ELIX R	S. 048/P. 048	ELSA E27	S. 112/P. 112
SERIE 146 HV GU10	S. 050/P. 050	DELIA E27	S. 114/P. 114
SERIE 223 HV GU10	S. 050/P. 050	DELIA	S. 114/P. 114
SERIE 3380 HV GU10	S. 050/P. 050	AURA E27	S. 116/P. 116
SERIE 015 G4	S. 051/P. 051	TITAN E27	S. 116/P. 116
SERIE 1101 HV GU10	S. 051/P. 051	LINA E27	S. 118/P. 118
WILLI 68R	S. 052/P. 052	TILIA E27	S. 118/P. 118
SERIE 68 HV GU10	S. 054/P. 054	ISIS E27	S. 120/P. 120
SERIE 332 HV GU10	S. 054/P. 054	FORO SHORT PD	S. 124/P. 124
QANA ROUND R	S. 054/P. 054	FORO LONG PD	S. 124/P. 124
LIRO R	S. 058/P. 058	NOVEL	S. 126/P. 126
CHICCO SQUARE R	S. 060/P. 060	ALICA	S. 126/P. 126
IVY SQUARE R	S. 060/P. 060	BO SINGLE	S. 128/P. 128
KALIO SQUARE R	S. 061/P. 061	BO DOUBLE	S. 128/P. 128
AGON FLAT SQUARE	S. 062/P. 062	TAKE G9	S. 128/P. 128
AGON SQUARE	S. 062/P. 062	AROK	S. 130/P. 130
SATOR SQUARE	S. 064/P. 064	CLARUS	S. 131/P. 131
PONTOS SQUARE	S. 064/P. 064	SERIE 44 SHORT SD	S. 132/P. 132
SERIE 4236 HV GU10	S. 066/P. 066	SERIE 44 LONG SD	S. 132/P. 132
QANA SQUARE R	S. 066/P. 066	MATAR	S. 132/P. 132
QANA DOUBLE SQUARE R	S. 066/P. 066	LANU ROUND W	S. 134/P. 134
MOON ROUND R	S. 070/P. 070	LANU FLAT W	S. 135/P. 135
MOON SQUARE R	S. 070/P. 070	MOTUS LONG W	S. 136/P. 136
MAAN SQUARE	S. 072/P. 072	ZHOOM W	S. 136/P. 136
MAAN ROUND	S. 072/P. 072	WALL 68R	S. 140/P. 140
AEON ROUND SMALL	S. 080/P. 080	WALL 68R IP44	S. 142/P. 142
AEON ROUND BIG	S. 080/P. 080	WINDOW I	S. 144/P. 144
AEON SQUARE SMALL	S. 082/P. 082	PAN	S. 144/P. 144
AEON SQUARE BIG	S. 082/P. 082	WINDOW II	S. 145/P. 145
POLUS	S. 084/P. 084	3-PHASE SCHIENE/TRACK	S. 148/P. 148
UP AC	S. 084/P. 084	3-PHASE SCHIENE DALI/TRACK DALI	S. 150/P. 150
LIRO SD	S. 084/P. 084	MOOVE TRACK	S. 154/P. 154
CARMI	S. 086/P. 086	SHOPSTAR LEAN TRACK	S. 154/P. 154
ARIK SHORT	S. 087/P. 087	MAG TRACK	S. 156/P. 156
DESCO M	S. 088/P. 088	MAGIS TRACK	S. 156/P. 156
DESCO L	S. 088/P. 088	TRACK SET MOOVE	S. 158/P. 158
MAG SDI	S. 090/P. 090	TRACK SET MAG	S. 159/P. 159
MAG SD TURN	S. 090/P. 090	RETRO 595R	S. 162/P. 162
MAGIS MINI SD	S. 092/P. 092	RETRO 620R	S. 162/P. 162
MAGIS MINI DOUBLE SD	S. 092/P. 092	RETRO 1230R	S. 162/P. 162
MAGIS SD	S. 094/P. 094	FIT	S. 164/P. 164
MAGIS DOUBLE SD	S. 094/P. 094	FIT LONG	S. 164/P. 164
MISSOR I	S. 098/P. 098	RUBE PDI	S. 166/P. 166
MISSOR II	S. 098/P. 098		
MISSOR I SD GU10	S. 100/P. 100		
MISSOR II SD GU10	S. 100/P. 100		
MISSOR III SD GU10	S. 100/P. 100		
MISSOR III SD GU10	S. 100/P. 100		
QANA ROUND SD	S. 102/P. 102		

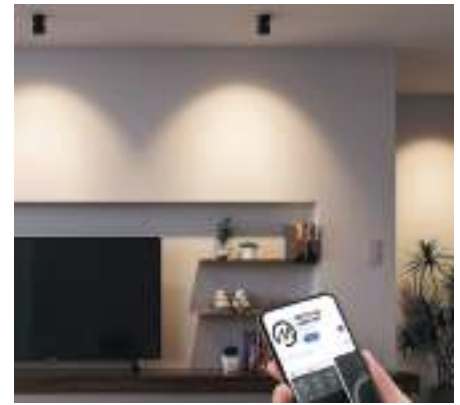

OUTDOOR

IVY ROUND R	S. 174/P. 174
CHICCO ROUND	S. 174/P. 174
IVY SQUARE R	S. 176/P. 176
CHICCO SQUARE	S. 176/P. 176
NONA MINI	S. 179/P. 179
NONA	S. 179/P. 179
FORIS SD	S. 181/P. 181
WILLIAM SD	S. 181/P. 181
FORIS W	S. 183/P. 183
FORIS DOUBLE W	S. 183/P. 183
WILLIAM W	S. 183/P. 183
SOPO ROUND M	S. 185/P. 185
SOPO ROUND L	S. 185/P. 185
SOPO SQUARE M	S. 185/P. 185
SOPO SQUARE L	S. 185/P. 185
TURN 2 SD GU10	S. 186/P. 186
FYNN O SD	S. 186/P. 186
LINE 25W	S. 188/P. 188
LINE 25 DOUBLE	S. 188/P. 188
LINE 50W	S. 188/P. 188
LINE 50 DOUBLE	S. 188/P. 188
WADO W	S. 190/P. 190
WADO DOUBLE W	S. 190/P. 190
CORBA ROUND W	S. 191/P. 191
CORBA SQUARE W	S. 191/P. 191
NEXT W	S. 192/P. 192
BEN ROUND W	S. 192/P. 192
BEN SQUARE W	S. 192/P. 192
PARE W	S. 194/P. 194
NELL W	S. 195/P. 195
FOCO W	S. 195/P. 195
PIGO W	S. 196/P. 196
ZEON W	S. 196/P. 196
FYNN C W	S. 196/P. 196
KODA TEN ONE	S. 198/P. 198
KODA TEN TWO	S. 198/P. 198
KODA TEN STRETTO	S. 198/P. 198
KODA TWENTY ONE	S. 198/P. 198
KODA TWENTY TWO	S. 198/P. 198
KODA THIRTY ONE	S. 199/P. 199
KODA THIRTY TWO	S. 199/P. 199
CADO MINI W	S. 200/P. 200
CADO W	S. 201/P. 201
MONA MINI F	S. 204/P. 204
MONA F	S. 204/P. 204
YARA ROUND F	S. 206/P. 206
YARA SQUARE F	S. 206/P. 206
ZEON F	S. 207/P. 207
BOOPER F	S. 208/P. 208
ALIAR F	S. 208/P. 208
WILLIAM F	S. 211/P. 211
FYNN CP F	S. 211/P. 211
CHOPA F	S. 214/P. 214
HARK	S. 214/P. 214
FORIS F	S. 215/P. 215
MICRO RODIO SYM.	S. 216/P. 216
MICRO RODIO L SYM.	S. 216/P. 216
MINI RODIO SYM.	S. 217/P. 217
RODIO SYM. LED	S. 217/P. 217
ZUBEHÖR/ACCESSOIRES	S. 218/P. 218

FLEX.light

KONFIGURATOR/CONFIGURATOR	S. 224/P. 224
FLEX.light VANTI	S. 228/P. 228
FLEX.light LATO	S. 230/P. 230
FLEX.light COLLINA	S. 232/P. 232
FLEX.light PREMIUM 5W	S. 234/P. 234
FLEX.light PREMIUM 9W	S. 235/P. 235
FLEX.light PREMIUM 18W	S. 235/P. 235
FLEX.light PREMIUM 28W	S. 235/P. 235
FLEX.light BASIC 4,8W	S. 238/P. 238
FLEX.light BASIC 9,6W	S. 238/P. 238
FLEX.light BASIC 14,4W	S. 240/P. 240
FLEX.light DIM2WARM 14,4W	S. 242/P. 242
FLEX.light TUNABLE WHITE 14,4W	S. 242/P. 242
FLEX.light RGBW 18,1W	S. 244/P. 244
FLEX.light 4,8W (IP67)	S. 246/P. 246
FLEX.light 14,4W (IP67)	S. 246/P. 246
FLEX.light TUNABLE WHITE 14,4W (IP67)	S. 247/P. 247
FLEX.light RGBW 18,1W (IP67)	S. 248/P. 248
FLEX.light BASIC 48V 4,8W (IP67)	S. 250/P. 250
AUFBAUPROFIL/SURFACE PROFIL	S. 252/P. 252
EINBAUPROFIL/RECESSED PROFIL	S. 262/P. 262

ACCESSOIRES

KONSTANTSPANNUNGSKONVERTER/ CONSTANT VOLTAGE DRIVER	S. 266/P. 266
KONSTANTSPANNUNGSKONVERTER DIM/ CONSTANT VOLTAGE DRIVER DIM.	S. 270/P. 270
DALI STEUERUNG/ DALI CONTROL	S. 274/P. 274
LICHTSZENEKONTROLLER DALI/ LIGHT SCENE CONTROLLER DALI	S. 275/P. 275
FUNK-STEUERUNG/ RADIO CONTROLLER	S. 275/P. 275
BLUETOOTHSTEUERUNG/ BLUETOOTH CONTROLLER	S. 277/P. 277
TRANSFORMATOREN/ TRANSFORMER	S. 278/P. 278
KONSTANTSTROM KONVERTER/ CONSTANT CURRENT DRIVER	S. 279/P. 279
KONSTANTSTROM KONVERTER DIM/ CONSTANT CURRENT DRIVER DIM	S. 283/P. 283
LEUCHTMITTEL/ BULBS	S. 290/P. 290
SCHALTPLÄNE/WIRING DIAGRAMS	S. 294/P. 294

INDEX



TECNICO STYLE



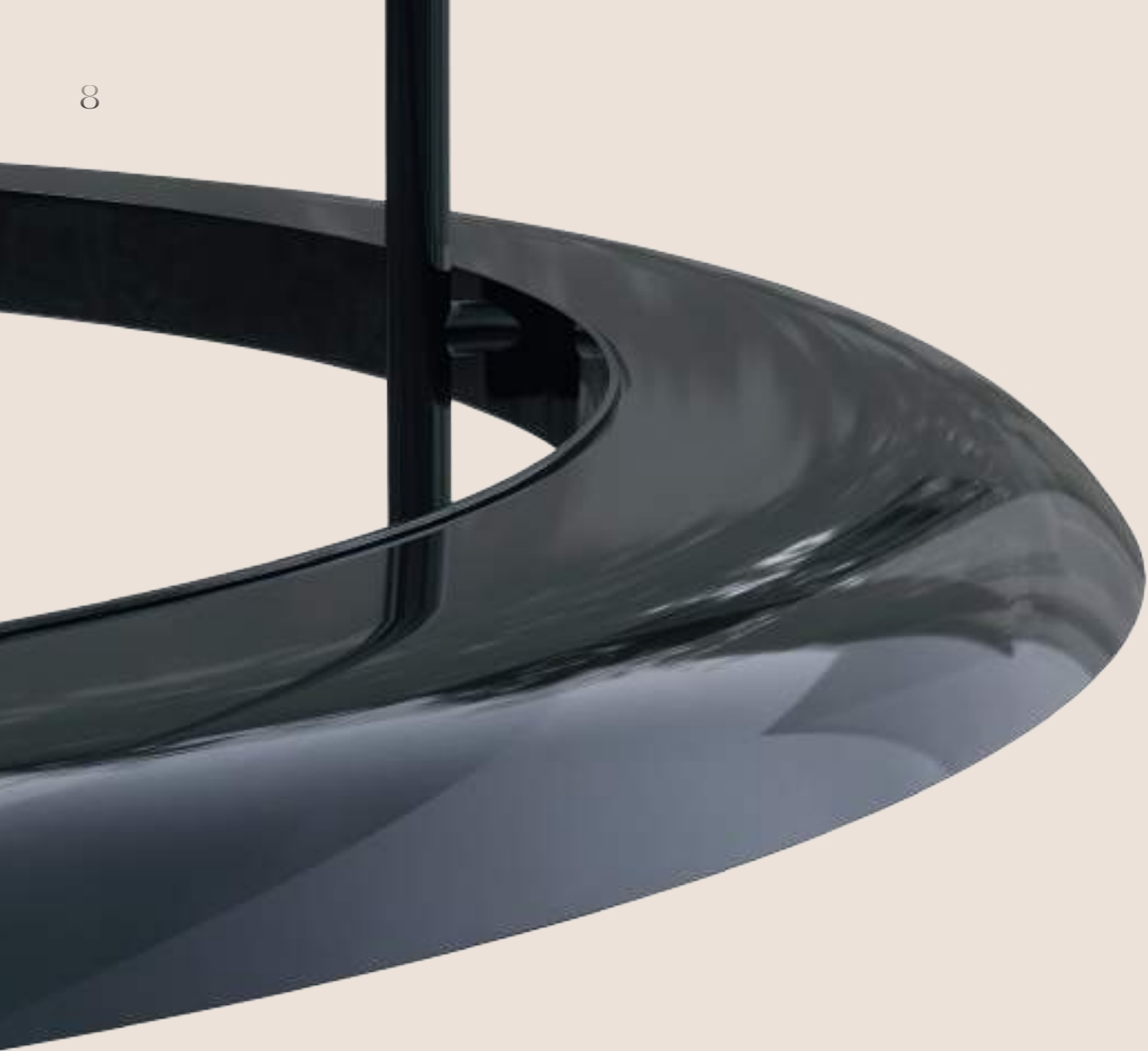

VUTO NEW

„Anello vuoto“ bedeutet „leerer Ring“. Dabei heißt „vuoto“ so viel wie „leer“ und erinnert an das Wort „Voute“, was Gewölbe bedeutet. Dies spiegelt sich im Konzept der Leuchte wieder. Eine elegante, flache Designerleuchte, entworfen von Johannes Tomm. Die Leuchte wird in zwei Oberflächen verfügbar sein. In einem edlem Klavierlack Schwarz oder optional in einem schlichteren Schwarz matt mit weißem Reflektor für eine effizientere Ausleuchtung. Unsere VUTO schwebt dank zwei sehr filigranen Halterungs-Stäben zeitlos im Raum. Die Leuchte wird DALI dimmbar und in der Lichtfarbe 2700K mit einem CRI90 erhältlich sein.

„Anello vuoto“ means „empty ring“. However, „vuoto“ means as „empty“ and is reminiscent of the word „voute“, which means arch. This is reflected in the concept of the luminaire. An elegant, flat designer luminaire, designed by Johannes Tomm. The luminaire will be available in two finishes. In an elegant black piano lacquer or optionally in a simpler matt black with a white reflector for more efficient illumination.

Our VUTO floats timelessly in the room thanks to two very delicate mounting rods. The luminaire is DALI dimmable and available in the light colour 2700K with a CRI90.

VUTO PD



ART. NR./CODE	LEISTUNG/POWER	LUMEN	CRI>	KELVIN	Ø x H	Abh./Susp.	FARBE/COLOUR	CHF
222-00110	SYS 35W	900	90	 2700	600 x 330	2500	 black/white	1198,80
222-00111	SYS 35W	900	90	 2700	600 x 330	2500	 glossy black/white	1318,80



TECNICO STYLE



10

Elegantes Design gepaart mit technischen Raffinessen setzt stilvolle Akzente in jedem Raum.

Elegant design paired with technical refinements sets stylish accents in any room.

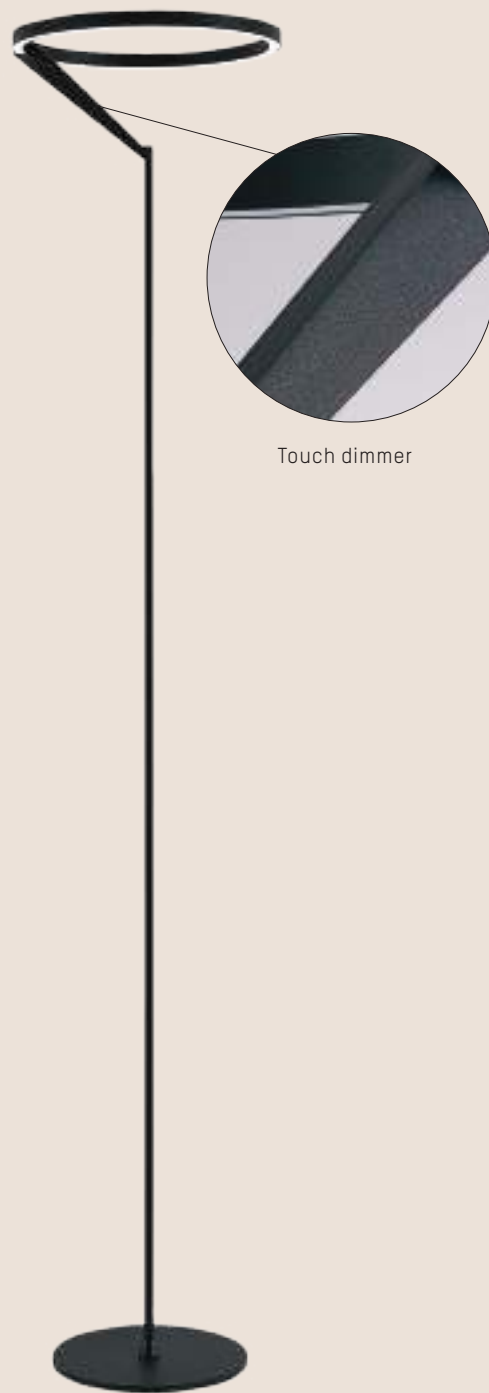

Touch dimmer

MELLI F



ART. NR./CODE	LEISTUNG/POWER	LUMEN	CRI>	KELVIN	Ø x H	FARBE/COLOUR	REFL.	CHF
222-00039	SYS 20W	960	90	2700/3000	330 x 1680	black	110°	598,80

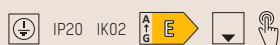

MELLI F



Die elegante Stehleuchte MELLI beeindruckt mit ihrem filigranen Leuchtendesign und setzt stilvolle Akzente in jedem Raum. Dank der einstellbaren Lichtfarbe (2700/3000K) können individuelle Lichtstimmungen geschaffen werden. Die Stehleuchte verfügt über einen praktischen Touchdimmer, der stufenloses Dimmen ermöglicht. Das hochwertige Gehäuse mit schwarzer Pulverbeschichtung verleiht MELLI eine edle Optik.

The elegant MELLI floor lamp impresses with its filigree luminaire design and sets stylish accents in any room. Thanks to the adjustable light colour (2700/3000K), individual lighting moods can be created.

The floor lamp has a practical touch dimmer that allows infinitely variable dimming. The high-quality housing with black powder coating gives MELLI a noble look.



MELLI

Stilvoll und funktional präsentiert sich die Leuchtenserie MELLI. Hergestellt aus hochwertigem Aluminium und in elegantem Schwarz gehalten, besticht sie durch ihr schlichtes Design und ihre vielseitigen Anwendungsmöglichkeiten. Egal, ob als Wand- oder Deckenleuchte oder sogar als Stehleuchte, sie erzeugt ein angenehmes Licht und schafft eine gemütliche Atmosphäre. Die Lichtfarbe kann je nach persönlichen Vorlieben zwischen warmweißem 2700K und neutralweißem 3000K variiert werden. Dies sollte vor der Montage eingestellt werden. Darüber hinaus kann MELLI je nach gewünschter Lichtwirkung entweder indirekt oder direkt/indirekt strahlend im Raum für perfekte Lichtstimmung sorgen.

The MELLI luminaire series is stylish and functional. Made from high-quality aluminium and finished in elegant black, it impresses with its simple design and versatile application options. Whether as a wall or ceiling light or even as a floor lamp, it produces a pleasant light and creates a cosy atmosphere. The light colour can be varied between warm white 2700K and neutral white 3000K depending on personal preference. This should be set before installation. In addition, depending on the desired lighting effect, MELLI can provide either indirect or direct/indirect light in the room to create the perfect lighting mood.

MELLI SDI direkt-indirekt/direct-indirect



ART. NR./CODE	LEISTUNG/POWER	LUMEN	CRI>	KELVIN	Ø x H	FARBE/COLOUR	CHF
222-00037	SYS 30W	1080/1140	90	2700/3000	330 x 146	black	478,80



MELLI SD indirekt/indirect



ART. NR./CODE	LEISTUNG/POWER	LUMEN	CRI>	KELVIN	Ø x H	FARBE/COLOUR	CHF
222-00038	SYS 15W	490/520	90	2700/3000	330 x 135	black	418,80





MELLI SDI

direkt-indirekter Lichtaustritt
direct-indirect light emission



MELLI SD

indirekter Lichtaustritt
indirect light emission



MEYJO



Mit einer angenehmen Farbtemperatur erzeugt MEYJO eine behagliche Atmosphäre und steigert das Wohlbefinden.

With a pleasant colour temperature, MEYJO creates a cosy atmosphere and increases well-being.



Sensor dimmer

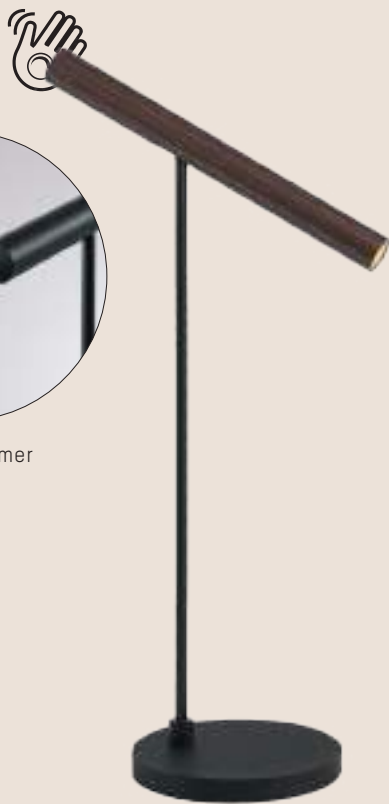

MEYJO T



ART. NR./CODE	LEISTUNG/POWER	LUMEN	CRI>	KELVIN	Ø x H x L/Ø x H x L	FARBE/COLOUR	REFL.	CHF
222-00048	SYS 9W	450	90	2700	140 x 435 x 250	black/black	28°	348,00
222-00049	SYS 9W	450	90	2700	140 x 435 x 250	black/gold	28°	348,00
222-00050	SYS 9W	450	90	2700	140 x 435 x 250	black/coffee	28°	348,00



MEYJO F



ART. NR./CODE	LEISTUNG/POWER	LUMEN	CRI>	KELVIN	Ø x H x L/Ø x H x L	FARBE/COLOUR	REFL.	CHF
222-00051	SYS 9W	450	90	2700	250 x 1400 x 250	black/black	28°	468,00
222-00052	SYS 9W	450	90	2700	250 x 1400 x 250	black/gold	28°	468,00
222-00053	SYS 9W	450	90	2700	250 x 1400 x 250	black/coffee	28°	468,00



MEYJO T/F



Die überarbeitete Tisch- und Stehleuchte MEYJO beeindruckt mit einer verbesserten Sensorensteuerung, die das Bedienen noch intuitiver gestaltet. Mithilfe der innovativen Gestensteuerung durch einen versteckten Sensor, lässt sich die Leuchte mühelos kontrollieren. Die stufenlose Dimmfunktion ermöglicht eine präzise Anpassung des Lichts an individuelle Bedürfnisse. Die neue MEYJO hat eine Höhe von nur mehr 1,4m, was erhöhte Stabilität bedeutet. Zudem erstrahlt die Leuchte in neuen, attraktiven Farbvarianten wie Schwarz, Gold gebürstet und Coffee gebürstet.

The improved MEYJO table and floor luminaire impresses with an improved sensor control that makes operation even more intuitive. The luminaire can be controlled effortlessly with the help of the innovative gesture control via a hidden sensor. The infinitely variable dimming function enables precise adjustment of the light to individual needs. The new MEYJO has a height of only 1.4m, which leads to increased stability. In addition, the luminaire shines in new, attractive colour variations such as black, brushed gold and brushed coffee.





PERFORA



Die neue PERFORA lässt ab sofort auch das Einstellen der Lichtfarbe auf 2700K oder 3000K zu. Dadurch lässt sich die Farbtemperatur an individuelle Vorlieben anpassen.

The new PERFORA also allows the light colour to be set to 2700K or 3000K, enabling the colour temperature to be adjusted to individual preferences.

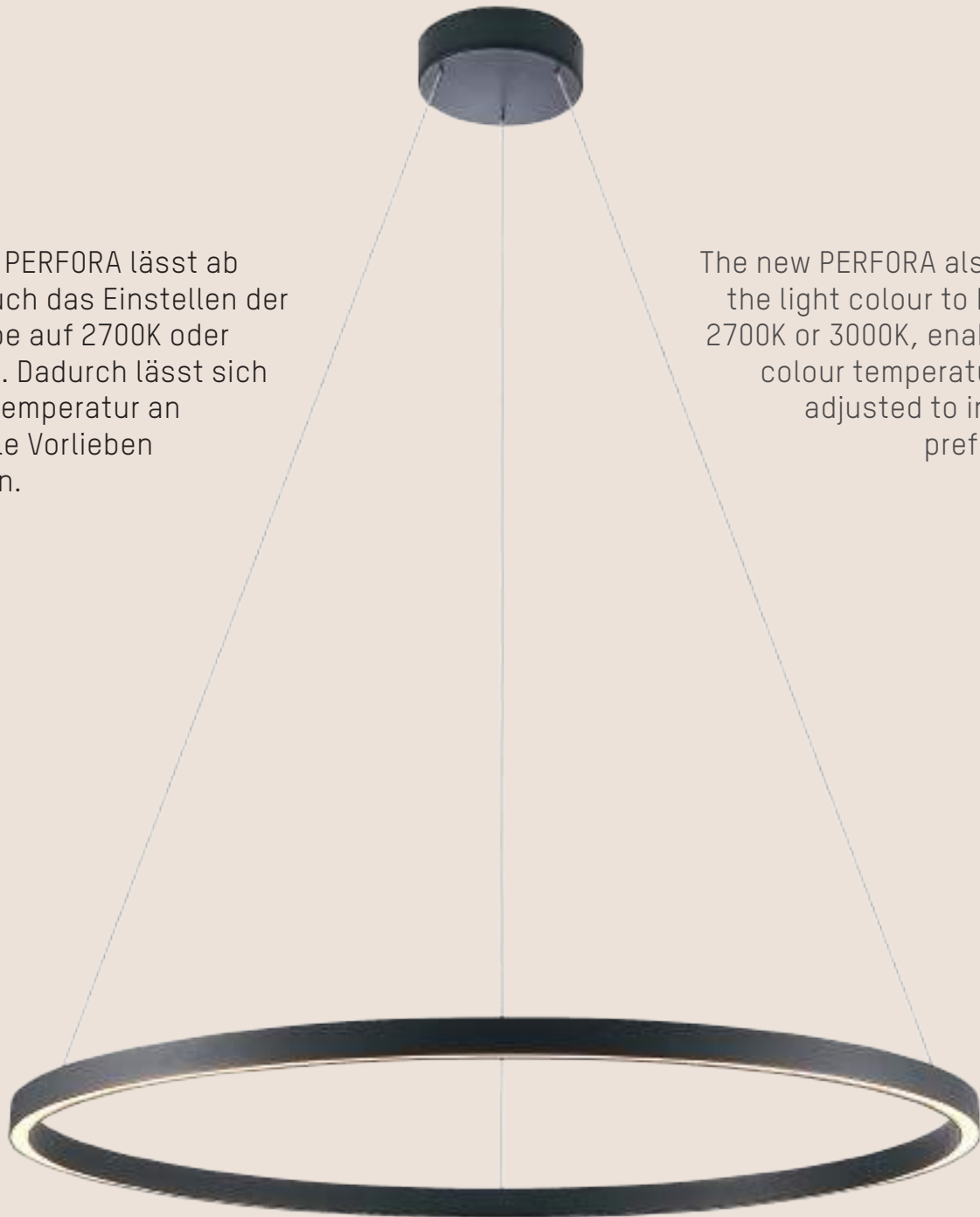

PERFORA M



ART. NR./CODE	LEISTUNG/POWER	LUMEN	CRI>	KELVIN	Ø x H	Abh./Susp.	FARBE/COLOUR	CHF
222-00073	SYS 38W	1870/2020	90	2700 / 3000	600 x 30	2000	white	802,80
222-00074	SYS 38W	1870/2020	90	2700 / 3000	600 x 30	2000	black	802,80

PERFORA L



ART. NR./CODE	LEISTUNG/POWER	LUMEN	CRI>	KELVIN	Ø x H	Abh./Susp.	FARBE/COLOUR	CHF
222-00075	SYS 65W	2890/3180	90	2700 / 3000	900 x 30	2000	white	1150,80
222-00076	SYS 65W	2890/3180	90	2700 / 3000	900 x 30	2000	black	1150,80

PERFORA



Die stilichere Ringleuchte PERFORA begeistert mit ihrer neuen Funktion: einer einstellbaren Lichtfarbe von 2700K oder 3000K. Damit bietet sie die Möglichkeit, die Farbtemperatur ganz nach individuellen Vorlieben anzupassen. Zudem ist PERFORA DALI dimmbar, wodurch die Lichtintensität flexibel reguliert werden kann. Das hochwertige pulverbeschichtete Finish verleiht der Leuchte eine edle Optik und sorgt für eine langlebige Oberfläche.

The stylish PERFORA ring luminaire inspires with its new function of an adjustable light colour of 2700K or 3000K. This luminaire offers the possibility of adjusting the colour temperature entirely according to individual preferences. In addition, PERFORA DALI is dimmable, allowing the light intensity to be flexibly regulated. The high-quality powder-coated finish gives the luminaire a noble appearance and ensures a long-lasting surface.



PERFORA PRO NEW

Die direkt- und indirekt leuchtend erhältliche PERFORA PRO kombiniert Nutzen und Design wie keine andere. Dank der niedrigen Blendwirkung (UGR18) und der angenehmen Farbtemperaturen von 2700K oder 3000K schafft sie ein dezentes aber doch wirkungsvolles Lichterlebnis. Die Leuchte ist per DALI2 und PUSH DIM steuerbar.

Available with direct and indirect light, PERFORA PRO combines utility and design like no other. Thanks to the low glare effect (UGR18) and the pleasant colour temperatures of 2700K or 3000K, it creates a discreet yet effective lighting experience. The luminaire can be controlled via DALI2 and PUSH DIM.



PERFORA PRO M direkt-indirekt/direct-indirect



ART. NR./CODE	LEISTUNG/POWER	LUMEN	CRI>	KELVIN	Ø x H/Ø x H	Abh./Susp.	FARBE/COLOUR	CHF
222-00156	SYS 45W	↓ 2320/3480 ↑	90	2700/3000	655 x 38	3000	black	958,80



PERFORA PRO L direkt-indirekt/direct-indirect



ART. NR./CODE	LEISTUNG/POWER	LUMEN	CRI>	KELVIN	Ø x H/Ø x H	Abh./Susp.	FARBE/COLOUR	CHF
222-00157	SYS 60W	↓ 3120/6240 ↑	90	2700/3000	905 x 38	3000	black	1198,80



PERFORA PRO XL direkt-indirekt/direct-indirect



ART. NR./CODE	LEISTUNG/POWER	LUMEN	CRI>	KELVIN	Ø x H/Ø x H	Abh./Susp.	FARBE/COLOUR	CHF
222-00158	SYS 80W	↓ 4160/6240 ↑	90	2700/3000	1205 x 38	3000	black	1498,80







NUUN NEW

Namensgeber sind die U-förmigen Leuchtenköpfe die auf der mattschwarzen Mittelstange angereiht sind. Gold oder coffee gebürstet kombiniert mit matt schwarz wirkt sie elegant als Pendel über dem Esstisch oder als variabel einstellbare Aufbauleuchte. Die Köpfe sind dreh- und schwenkbar. Die Leuchte selbst ist über einen DIP-Switch 2700/3000K einstellbar und DALI dimmbar. Die Leuchtserie NUUN ist somit eine elegante und dekorative Ergänzung im TECNICO STYLE

Named by the U-shaped luminaire heads, which are arranged on the matt black centre bar. Brushed gold or coffee combined with matt black, it looks elegant as a pendant above the dining table or as a variably adjustable surface-mounted luminaire. The heads can be swivelled and tilted. The light itself is adjustable via a dipswitch 2700/3000K and DALI dimmable. The NUUN luminaire series is therefore an elegant and decorative addition to the TECNICO STYLE



NUUN SD

ART. NR./CODE	LEISTUNG/POWER	LUMEN	CRI>	KELVIN	L x B x H/L x W x H	FARBE/COLOUR	CHF
222-00126	SYS 18W	1410	90	2700/3000	900 x 70 x 245	black/gold	598,80
222-00127	SYS 18W	1410	90	2700/3000	900 x 70 x 245	black/coffee	598,80

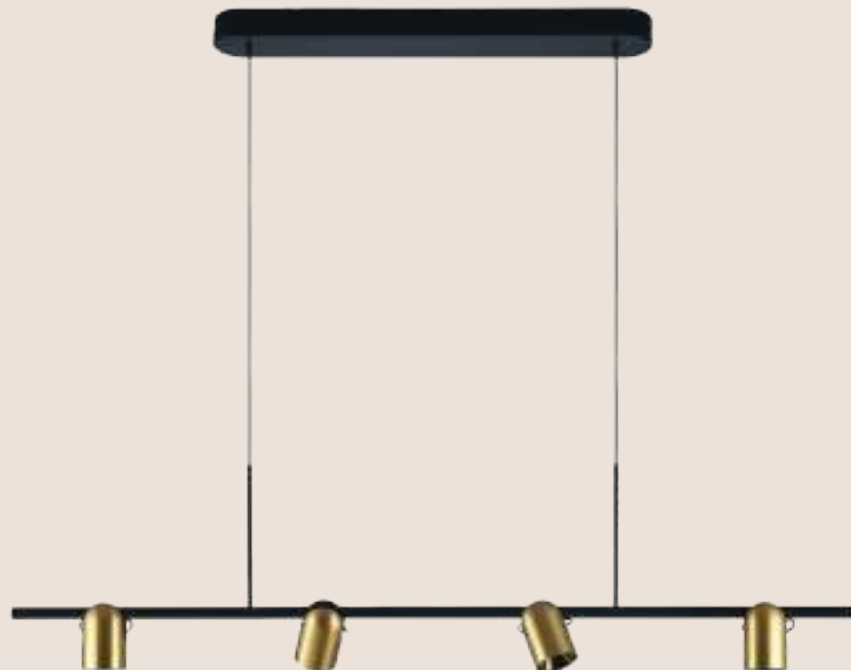

NUUN PD

ART. NR./CODE	LEISTUNG/POWER	LUMEN	CRI>	KELVIN	L x B x H/L x W x H	Abh./Susp.	FARBE/COLOUR	CHF
222-00124	SYS 25W	1880	90	2700/3000	1150 x 60 x 90	2500	black/gold	778,80
222-00125	SYS 25W	1880	90	2700/3000	1150 x 60 x 90	2500	black/coffee	778,80



GILO



Die schlichte und minimalistische Hängeleuchte aus Aluminiumdruckguss GILO PD mit opalem Acryl Diffusor glänzt durch zeitloses Design. Die pulverbeschichtete Oberfläche sowie der Konverter und Deckenbaldachin sind in matt Weiß oder Schwarz erhältlich. Die Länge der Abhängung beläuft sich auf 2000mm.

The simple and minimalist GILO PD pendant light made of with an opal acrylic diffuser boasts a timeless design. The powder-coated surface as well as the driver and ceiling canopy are available in matt white or black. The length of the suspension is 2000mm.



GILO PD



ART. NR./CODE	LEISTUNG/POWER	LUMEN	CRI>	KELVIN	Ø x H	Abh./Susp.	FARBE/COLOUR	CHF
472-2429150	SYS 6W	340	90	3000	80 x 90	2000	white	214,80
472-2429160	SYS 6W	340	90	3000	80 x 90	2000	black	214,80



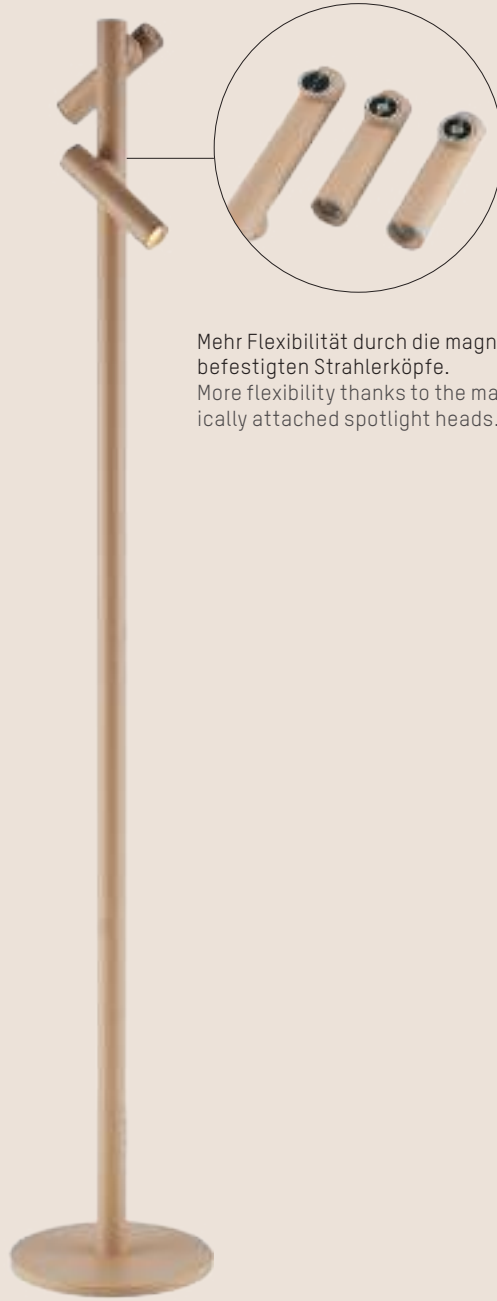

Mehr Flexibilität durch die magnetisch befestigten Strahlerköpfe.
More flexibility thanks to the magnetically attached spotlight heads.

MIMO T



ART. NR./CODE	V DC USB ACCU	LUMEN	CRI>	KELVIN	Ø x H	FARBE/COLOUR	CHF
333-00001	2,2W	50	80	2700	30 x 358	anthracite	178,80
333-00002	2,2W	50	80	2700	30 x 358	sand	178,80



MIMO F



ART. NR./CODE	V DC USB ACCU	LUMEN	CRI>	KELVIN	Ø x H	FARBE/COLOUR	CHF
333-00003	2,2W	50	80	2700	30 x 1200	anthracite	238,80
333-00004	2,2W	50	80	2700	30 x 1200	sand	238,80

MIMO DOUBLE F



ART. NR./CODE	V DC USB ACCU	LUMEN	CRI>	KELVIN	Ø x H	FARBE/COLOUR	CHF
333-00005	2,2W	100	80	2700	30 x 1200	anthracite	298,80
333-00006	2,2W	100	80	2700	30 x 1200	sand	298,80



MIMO NEW



Unsere Akkuleuchte MIMO überzeugt neben dem ansprechendem Design auch durch angenehm warmweißes Licht (2700K). Dank des Schutzfaktors IP54 kann die Leuchte im Innen- aber auch im Außenbereich verwendet werden. Egal ob als Leseleuchte oder als Ergänzung für die Outdoor Lounge. Dank ihrem magnetisch befestigten und 360° schwenkbaren Leuchten-Kopf bietet MIMO volle Flexibilität.

In addition to its attractive design, our rechargeable MIMO light also impresses with its pleasant warm white light (2700K). Thanks to the IP54 protection factor, the light can be used both indoors and outdoors. Whether as a reading light or as an addition to the outdoor lounge. Thanks to its magnetically attached and 360° swivelling light head, MIMO offers complete flexibility.





Unsere EEDEN S T sorgt dank Tunable White (2700K bis 3000K), für eine angenehme Atmosphäre auf jedem Tisch. Sie ist in 4 Farben erhältlich und mit ihrem satinierten Leuchtenkopf ein echter Hingucker. Dank 8h Akkulaufzeit bei gleichbleibender Leuchtkraft ist sie bereit für stimmungsvolle Abende.

Thanks to tunable white (2700K to 3000K), our EEDEN S T creates a pleasant atmosphere on any table. It is available in 4 colours and is a real eye-catcher with its satined luminaire head. Thanks to its 8-hour battery life with constant luminosity, it is ready for atmospheric evenings.



EEDEN S T

ART. NR./CODE	V DC USB ACCU	LUMEN	CRI>	KELVIN	Ø x H/Ø x H	FARBE/COLOUR	CHF
135-9006ss5t	3,7	120	80	2700/ 3000	126 x 369	green	154,80
135-9006su5t	3,7	120	80	2700/ 3000	126 x 369	rust brown	154,80
135-9006s65t	3,7	120	80	2700/ 3000	126 x 369	black	154,80
135-9006s95t	3,7	120	80	2700/ 3000	126 x 369	anthracite	154,80



KERAMIKSCHIRM/CERAMIC SCREEN

ART. NR./CODE	FARBE/COLOUR	CHF
135-000100b0	seablue	94,80
135-000100f0	omeagreen	94,80
135-000100r0	bronze	94,80
135-000100s0	deer grey	130,80





Im Unterschied zur S Version bietet die M Version der EEDEN Tischleuchte eine noch höhere Akkulaufzeit von bis zu 11h bei 100% Leuchtkraft. Zudem ist sie in 3 Stufen dimmbar. Ihre Leuchtenköpfe sind zu je 3 Stück stapelbar, was eine einfache Lagerung und ein schnelles Aufladen über Nacht ermöglicht.

In comparison to the S version, the M version of the EEDEN table luminaire offers an even longer battery life of up to 11 hours at 100% luminosity. It is also dimmable in 3 levels. The lamp heads can be stacked in batches of 3, making them easy to store and quick to recharge overnight.

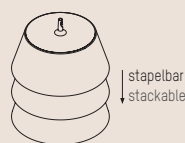

EEDEN M T Version mit Standfuss/Version with stand



EEDEN M T



EEDEN M C T

ART. NR./CODE	V DC USB ACCU	LUMEN	CRI>	KELVIN	Ø x H/Ø x H	FARBE/COLOUR	CHF
135-9002366t	3,7	140	80	2700	210 x 448	black	226,80
135-9002966t	3,7	140	80	3000	210 x 448	black	226,80

EEDEN M T Version mit Tischklammer/Version with table clamb

135-9003366t	3,7	140	80	2700	210 x 448	black	226,80
135-9003966t	3,7	140	80	3000	210 x 448	black	226,80



Durch einen robusten Standfuß oder Erdspieß aus Metall hält die EEDEN M F allen Einsatzmöglichkeiten stand. Wie auch bei der EEDEN M T machen die lange Akkulaufzeit von 11h und die stapelbaren Leuchtenköpfe sie zu einem praktischen Eyecatcher im In- und Outdoor Bereich.

Thanks to a robust metal base or ground spike, the EEDEN M F is ideal for any application. As with the EEDEN M T, the long battery life of 11 hours and the stackable lamp heads make it a practical eye-catcher for indoor and outdoor use.



EEDEN M F 1

EEDEN M F 2

EEDEN M F 1 Version mit Standfuss/Version with stand

ART. NR./CODE	V DC USB ACCU	LUMEN	CRI>	KELVIN	Ø x H/Ø x H	FARBE/COLOUR	CHF
135-9004366t	3,7	140	80	2700	280 x 1300	black	274,80
135-9004966t	3,7	140	80	3000	280 x 1300	black	274,80

EEDEN M F 2 Version mit Erdspieß/Version with ground pike

135-9005366t	3,7	140	80	2700	210 x 1540	black	226,80
135-9005966t	3,7	140	80	3000	210 x 1540	black	226,80

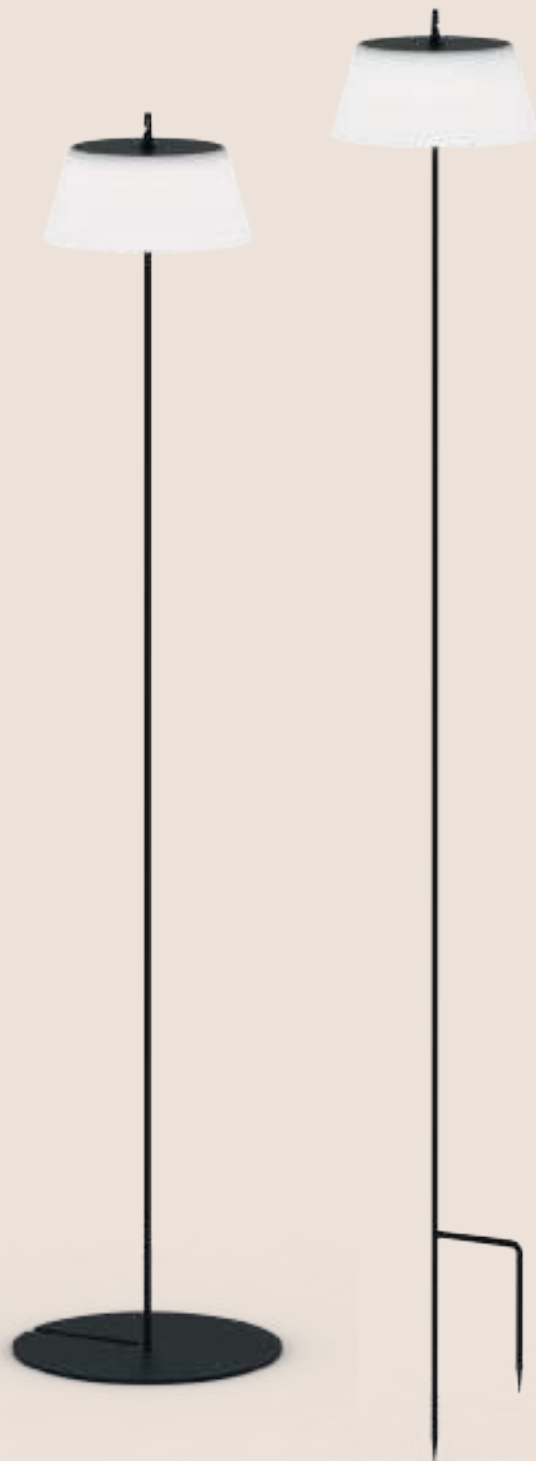
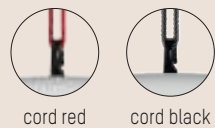
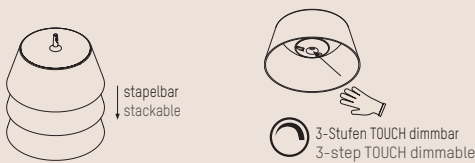

Die EEDEN Produktfamilie wird durch eine Pendelversion abgerundet. Dank dem, in Schwarz oder Rot erhältlichen, Abhängungsseil sind die individuellen Montage-Möglichkeiten nahezu endlos.

The EEDEN product family is rounded off by a pendant version. Thanks to a suspension cord, available in red or black, the individual mounting options are almost endless.

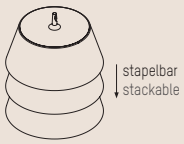

stapelbar
stackable



3-Stufen TOUCH dimmbar
3-step TOUCH dimmable



EEDEN M PD



ART. NR./CODE	V DC USB ACCU	LUMEN	CRI>	KELVIN	Ø x H/Ø x H	SEIL/CORD	FARBE/COLOUR	CHF
135-9001366t	3,7	140	80	2700	210 x 128	black	black	178,80
135-9001966t	3,7	140	80	3000	210 x 128	black	black	178,80
135-900136tt	3,7	140	80	2700	210 x 128	red	black	178,80
135-900196tt	3,7	140	80	3000	210 x 128	red	black	178,80



IP65













































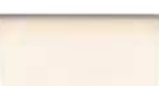





TECNICO INDOOR

TECNICO INDOOR

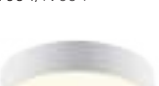
DECKENEINBAULEUCHTEN
CEILING RECESSED LUMINAIRES

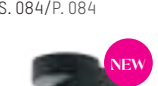
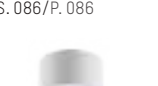
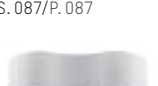

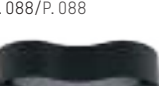
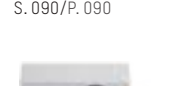
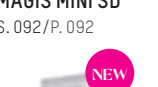
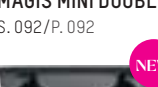
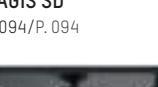
PRODUKTÜBERSICHT/INDEX

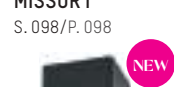
					
CHICCO ROUND R S. 039/P. 039	IVY ROUND R S. 039/P. 039	SUNRAY I/II/III/IV S. 040/P. 040	SPEAKER 1/2 S. 042/P. 042	ENERGY 2130/2180/2245 S. 042/P. 042	AGON FLAT ROUND S. 044/P. 044
					
AGON ROUND S. 045/P. 045	SATOR S. 046/P. 046	PONTOS ROUND S. 046/P. 046	KALIO ROUND R S. 047/P. 047	ELIX MINI R S. 048/P. 048	ELIX R S. 048/P. 048
					
SERIE 146 HV GU10 S. 050/P. 050	SERIE 223 HV GU10 S. 050/P. 050	SERIE 3380 HV GU10 S. 050/P. 050	SERIE 015 G4 S. 051/P. 051	SERIE 1101 HV GU10 S. 051/P. 051	WILLI 68R S. 052/P. 052
					
SERIE 68 HV GU10 S. 054/P. 054	SERIE 332 HV GU10 S. 054/P. 054	QANA ROUND R S. 054/P. 054	LIRO R S. 058/P. 058	CHICCO SQUARE R S. 060/P. 060	IVY SQUARE R S. 060/P. 060
					
KALIO SQUARE R S. 061/P. 061	AGON FLAT SQUARE S. 062/P. 062	AGON SQUARE S. 062/P. 062	SATOR SQUARE S. 064/P. 064	PONTOS SQUARE S. 064/P. 064	SERIE 4236 HV GU10 S. 066/P. 066
					
QANA SQUARE R S. 066/P. 066	QANA DOUBLE SQUARE R S. 066/P. 066	MOON ROUND R S. 070/P. 070	MOON SQUARE R S. 070/P. 070	MAAN SQUARE S. 072/P. 072	MAAN ROUND S. 072/P. 072
					
AEON ROUND SMALL S. 080/P. 080	AEON ROUND BIG S. 080/P. 080	AEON SQUARE SMALL S. 082/P. 082	AEON SQUARE BIG S. 082/P. 082	POLUS S. 084/P. 084	UP AC S. 084/P. 084
					
LIRO SD S. 084/P. 084	CARMi S. 086/P. 086	ARIK SHORT S. 087/P. 087	DESCO M S. 088/P. 088	DESCO L S. 088/P. 088	MAG SDi S. 090/P. 090
					
MAG SD TURN S. 090/P. 090	MAGiS MINI SD S. 092/P. 092	MAGiS MINI DOUBLE SD S. 092/P. 092	MAGiS SD S. 094/P. 094	MAGiS DOUBLE SD S. 094/P. 094	MISSOR I S. 098/P. 098
					
MISSOR II S. 098/P. 098	MISSOR I SD GU10 S. 100/P. 100	MISSOR II SD GU10 S. 100/P. 100	MISSOR III SD GU10 S. 100/P. 100	QANA ROUND SD S. 102/P. 102	QANA BOX I SD S. 102/P. 102



QANA BOX 2 SD
S. 102/P. 102



MUSO ROUND SD
S. 106/P. 106



MUSO ROUND SD SENSOR
S. 106/P. 106



MUSO ROUND SD DALI
S. 106/P. 106



MUSO SQUARE SD
S. 108/P. 108



MUSO SQUARE SD SENSOR
S. 108/P. 108



MUSO LINEAR SD
S. 110/P. 110



MUSO 120 LINEAR CCT DALI
S. 110/P. 110



ALKOR 2 E27
S. 112/P. 112



APUS E27
S. 112/P. 112



ELSA E27
S. 112/P. 112



DELIA E27
S. 114/P. 114



DELIA
S. 114/P. 114



AURA E27
S. 116/P. 116



TITAN E27
S. 116/P. 116



LINA E27
S. 118/P. 118



TILIA E27
S. 118/P. 118



ISIS E27
S. 120/P. 120



FORO SHORT PD
S. 124/P. 124



FORO LONG PD
S. 124/P. 124



NOVEL
S. 126/P. 126



ALICA
S. 126/P. 126



BO SINGLE
S. 128/P. 128



BO DOUBLE
S. 128/P. 128



TAKE G9
S. 128/P. 128



AROK
S. 130/P. 130



CLARUS
S. 131/P. 131



SERIE 44 SHORT SD
S. 132/P. 132



SERIE 44 LONG SD
S. 132/P. 132



MATAR
S. 132/P. 132



LANU ROUND W
S. 134/P. 134



LANU FLAT W
S. 135/P. 135



MOTUS LONG W
S. 136/P. 136



ZHOOM W
S. 136/P. 136



WALL 68R
S. 140/P. 140



WALL 68R IP44
S. 142/P. 142



WINDOW I
S. 144/P. 144



PAN
S. 144/P. 144



WINDOW II
S. 145/P. 145



3-PHASE TRACK
S. 148/P. 148



3-PHASE TRACK DALI
S. 150/P. 150



MOOVE TRACK
S. 154/P. 154



SHOPSTAR LEAN TRACK
S. 154/P. 154



MAG TRACK
S. 156/P. 156



MAGIS TRACK
S. 156/P. 156



TRACK SET MOOVE
S. 158/P. 158



TRACK SET MAG
S. 159/P. 159



RETRO 595R
S. 162/P. 162

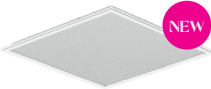

RETRO 620R
S. 162/P. 162



RETRO 1230R
S. 162/P. 162



FIT
S. 164/P. 164



FIT LONG
S. 164/P. 164



RUBE PDI
S. 166/P. 166

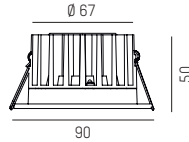

Einbaustrahler, Aluminiumdruckguss, Feinstruktur matt pulverbeschichtet, starr, zurückversetzte Lichtquelle, excl. Konverter

Recessed spotlight, die-cast aluminium, powder-coated, fixed, recessed light source, excl. driver

CHICCO ROUND R



ART. NR./CODE	LEISTUNG/POWER	mA	LUMEN	CRI>	KELVIN	Ø x ET/Ø x ID	⊙	FARBE/COLOUR	REFL.	CHF
308-0010790302704	LED 7W	350	530	90	2700	90 x 80	78	silver	30°	64,80
308-0010790302705	LED 7W	350	540	90	2700	90 x 80	78	white	30°	64,80
308-0010790302706	LED 7W	350	510	90	2700	90 x 80	78	black	30°	64,80
308-0010790303004	LED 7W	350	560	90	3000	90 x 80	78	silver	30°	64,80
308-0010790303005	LED 7W	350	590	90	3000	90 x 80	78	white	30°	64,80
308-0010790303006	LED 7W	350	560	90	3000	90 x 80	78	black	30°	64,80



KONVERTER/DRIVER



ART. NR./CODE	INFO	WATT	mA	V DC	V AC	L x B x H/L x W x H	FARBE/COLOUR	CHF
30-880006	on/off	15W	350	44	230	156 x 43 x 30	white	15,60
24-151403	DALI	17W	350	49	230	111 x 52 x 22	white	68,64

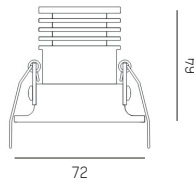

Einbaustrahler, Aluminiumdruckguss, Feinstruktur matt pulverbeschichtet, starr, zurückversetzte Lichtquelle, excl. Konverter

Recessed spotlight, die-cast aluminium, powder-coated, fixed, with recessed light source, 2 beam angles, excl. driver

IVY ROUND R



ART. NR./CODE	LEISTUNG/POWER	mA	LUMEN	CRI>	KELVIN	Ø x ET/Ø x ID	⊙	FARBE/COLOUR	REFL.	CHF
472-0260790203005	LED 7W	200	700	90	3000	72 x 94	60	white	20°	70,80
472-0260790203006	LED 7W	200	660	90	3000	72 x 94	60	black	20°	70,80
472-0260790403005	LED 7W	200	640	90	3000	72 x 94	60	white	40°	70,80
472-0260790403006	LED 7W	200	630	90	3000	72 x 94	60	black	40°	70,80



KONVERTER/DRIVER



ART. NR./CODE	INFO	WATT	mA	V DC	V AC	L x B x H/L x W x H	FARBE/COLOUR	CHF
30-880006	on/off	8,5W	200	44	230	156 x 43 x 30	white	15,60
24-151395	DALI	9W	180	50	230	108 x 52 x 22	white	69,84



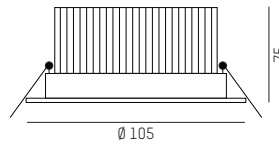

Einbaustrahler, Aluminiumdruckguss, Feinstruktur matt pulverbeschichtet, passiv gekühlt, starr, Schutzglas, excl. Konverter

Recessed spotlight, die-cast aluminium, fine structure matt powder-coated, passively cooled, rigid, protective glass, excl. converter

SUNRAY I



ART. NR./CODE	UGR<19		CRI>	KELVIN	Ø x ET/Ø x ID	Ⓢ	FARBE/COLOUR	REFL.	CHF
	LUMEN/W BEI 250mA LUMEN/W WITH 250mA	LUMEN/W BEI 350mA LUMEN/W WITH 350mA							
	LED 10W	LED 14W							
8-09519455	1000	1400	80	3000	105 x 105	95	white	36°	58,80
8-09514455	1050	1500	80	4000	105 x 105	95	white	36°	58,80
 KONVERTER SEPARAT ORDERN/ORDER DRIVER SEPARATELY									
	30-880006	30-880106	on/off					15,60	16,80
	24-151403	24-151403	DALI					68,64	68,64

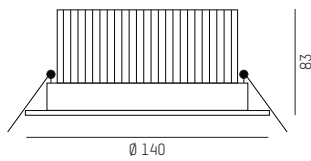

SUNRAY II



ART. NR./CODE	UGR<19			CRI>	KELVIN	Ø x ET/Ø x ID	Ⓢ	FARBE COLOUR	REFL.	CHF
	LUMEN/W BEI 350mA LUMEN/W WITH 350mA	LUMEN/W BEI 500mA LUMEN/W WITH 500mA	LUMEN/W BEI 700mA LUMEN/W WITH 700mA							
	LED 14W	LED 20W	LED 28W							
8-12519455	1450	1950	2750	80	3000	140 x 113	125	white	45°	82,80
8-12514455	1550	2100	2900	80	4000	140 x 113	125	white	45°	82,80
 KONVERTER SEPARAT ORDERN/ORDER DRIVER SEPARATELY										
	30-880106	30-880106	30-880106	on/off				16,80	16,80	16,80
	24-151403	24-127490	24-127490	DALI				68,64	81,36	81,36

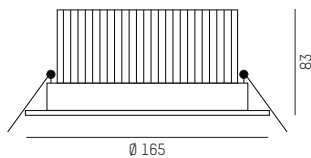

SUNRAY III



ART. NR./CODE	UGR<19			CRI>	KELVIN	Ø x ET/Ø x ID	Ⓢ	FARBE COLOUR	REFL.	CHF
	LUMEN/W BEI 350mA LUMEN/W WITH 350mA	LUMEN/W BEI 500mA LUMEN/W WITH 500mA	LUMEN/W BEI 700mA LUMEN/W WITH 700mA							
	LED 14W	LED 20W	LED 28W							
8-15019455	1650	2250	2850	80	3000	165 x 113	150	white	45°	106,80
8-15014455	1750	2400	3000	80	4000	165 x 113	150	white	45°	106,80
 KONVERTER SEPARAT ORDERN/ORDER DRIVER SEPARATELY										
	30-880106	30-880106	30-880106	on/off				16,80	16,80	16,80
	24-151403	24-127490	24-127490	DALI				68,64	81,36	81,36

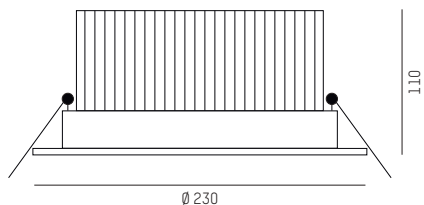

SUNRAY IV



ART. NR./CODE	UGR <19			CRI>	KELVIN	Ø x ET/Ø x ID	①	FARBE COLOUR	REFL.	CHF
	LUMEN/W BEI 500mA LUMEN/W WITH 500mA	LUMEN/W BEI 700mA LUMEN/W WITH 700mA	LUMEN/W BEI 1050mA LUMEN/W WITH 1050mA							
	LED 21W	LED 29W	LED 43W							
8-20519505	2300	3050	4150	80	3000	230 x 140	205	white	50°	142,80
8-20514505	2400	3150	4300	80	4000	230 x 140	205	white	50°	142,80
KONVERTER SEPARAT ORDERN/ORDER DRIVER SEPARATELY										
	30-880106	30-880106	24-122204	on/off				16,80	16,80	72,48
	24-127490	24-127490	24-15141350	DALI				81,36	81,36	85,20



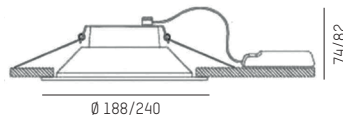

Einbaustrahler, Aluminiumblech tiefgezogene, einstellbare Stahlbügel, Diffusor Polycarbonat, inkl. Konverter, sichtbare Teile IP44, nicht sichtbare Teile IP20

Recessed spotlight, deep-drawn sheet aluminium, adjustable steel bracket, polycarbonate diffuser, incl. converter, visible parts IP44, non-visible parts IP20

NEW

SPEAKER 1/SPEAKER 2



ART. NR./CODE	LEISTUNG/POWER	LUMEN	CRI>	KELVIN	Ø x ET/Ø x ID	⊕	FARBE/COLOUR	REFL.	CHF
121-2208441000	SYS 14W	1200	80	3000	188 x 104	154-182	white	100°	46,80
121-2208441100	SYS 14W	1300	80	4000	188 x 104	154-182	white	100°	46,80
121-2208441500	SYS 25W	1900	80	3000	230 x 112	192-224	white	100°	52,80
121-2208441600	SYS 25W	2000	80	4000	230 x 112	192-224	white	100°	52,80

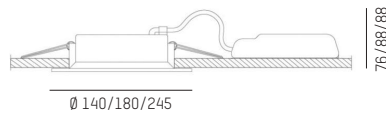

Einbaustrahler, Aluminiumdruckguss, starr, Diffusor aus Polycarbonat, inkl. Konverter, sichtbare Teile IP44, nicht sichtbare Teile IP20

Recessed spotlight, die-cast aluminium, rigid, polycarbonate diffuser, incl. converter, visible parts IP44, non-visible parts IP20

NEW

ENERGY 2130 / 2180 / 2245



ART. NR./CODE	LEISTUNG/POWER	LUMEN	CRI>	KELVIN	Ø x ET/Ø x ID	⊕	FARBE/COLOUR	REFL.	CHF
121-2217231439	SYS 7/10/11W	797/1106/1252	90	3000	140 x 76	110-135	white	100°	58,80
121-2217231400	SYS 7/10/11W	839/1164/1317	90	4000	140 x 76	110-135	white	100°	58,80
121-2217251539	SYS 9/13/14/19W	1097/1536/1702/2135	90	3000	180 x 88	160-175	white	100°	82,80
121-2217251500	SYS 9/13/14/19W	1147/1607/1830/2247	90	4000	180 x 88	160-175	white	100°	82,80
121-2217220139	SYS 14/18/19/20/22/25/26W	1845/2266/2379/2503/2729/3175/3289	90	3000	245 x 88	200-240	white	100°	94,80
121-2217220100	SYS 14/18/19/20/22/25/26W	1926/2385/2503/2626/2884/3342/3461	90	4000	245 x 88	200-240	white	100°	94,80

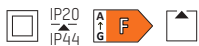



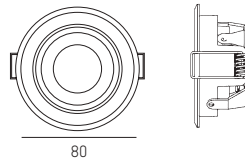
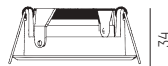

Einbaustrahler Aluminiumdruckguss, 2700 oder 3000K

Recessed spotlight die-cast aluminium, 2700 or 3000K switchable

NEW

AGON FLAT ROUND



ART. NR./CODE	LEISTUNG/POWER	mA	LUMEN	CRI>	KELVIN	Ø x ET/Ø x ID	⊕	FARBE/COLOUR	REFL.	CHF
222-00128	LED 5W	250	650	90	2700	80 x 64	68	white	55°	46,80
222-00129	LED 5W	250	650	90	2700	80 x 64	68	black	55°	46,80
222-00130	LED 5W	250	650	90	3000	80 x 64	68	white	55°	46,80
222-00131	LED 5W	250	650	90	3000	80 x 64	68	black	55°	46,80



KONVERTER/DRIVER



ART. NR./CODE	INFO	WATT	mA	V DC	V AC	L x B x H/L x W x H	FARBE/COLOUR	CHF
30-880006	on/off	11W	250	44	230	156 x 43 x 30	white	15,60
24-151403	DALI	12W	250	49	230	111 x 52 x 22	white	68,64



54

Einbaustrahler, Aluminiumdruckguss, gebürstet oder pulverbeschichtet, exkl. Konverter

spotlight, die-cast aluminium, brushed or powder-coated, excl. converter

NEW

AGON ROUND



ART. NR./CODE	LEISTUNG/POWER	mA	LUMEN	CRI>	KELVIN	Ø x ET/Ø x ID	Ⓢ	FARBE/COLOUR	REFL.	CHF
222-00136	LED 6/11W	250/500	415/705	90	2700	80 x 84	68	white	36°	58,80
222-00137	LED 6/11W	250/500	415/705	90	2700	80 x 84	68	black	36°	58,80
222-00138	LED 6/11W	250/500	475/830	90	3000	80 x 84	68	white	36°	58,80
222-00139	LED 6/11W	250/500	475/830	90	3000	80 x 84	68	black	36°	58,80



KONVERTER/DRIVER



ART. NR./CODE	INFO	WATT	mA	V DC	V AC	L x B x H/L x W x H	FARBE/COLOUR	CHF
30-880006	on/off	11W/18,5W	250/500	44	230	156 x 43 x 30	white	15,60
24-151403	DALI	12W/20W	250/500	49	230	111 x 52 x 22	white	68,64

TECNICO INDOOR



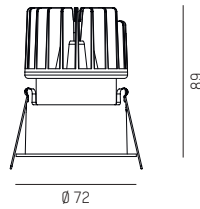

Einbaustrahler, Aluminiumdruckguss, Feinstruktur matt pulverbeschichtet, zurückversetzte Lichtquelle, exkl. Konverter

spotlight, die-cast aluminium, fine structure, matt powder-coated, recessed light source, excl. converter



SATOR

ART. NR./CODE	LEISTUNG/POWER	mA	LUMEN	CRI>	KELVIN	Ø x ET/Ø x ID	⊕	FARBE/COLOUR	REFL.	CHF
305-30013500	LED 10W	250	600	90	2700	72 x 119	68	white	24°	58,80
305-30013600	LED 10W	250	600	90	2700	72 x 119	68	black	24°	58,80
305-30019500	LED 10W	250	620	90	3000	72 x 119	68	white	24°	58,80
305-30019600	LED 10W	250	620	90	3000	72 x 119	68	black	24°	58,80



KONVERTER/DRIVER



ART. NR./CODE	INFO	WATT	mA	V DC	V AC	L x B x H/L x W x H	FARBE/COLOUR	CHF
30-880006	on/off	11W	250	44	230	156 x 43 x 30	white	15,60
24-151403	DALI	12W	250	49	230	111 x 52 x 22	white	68,64

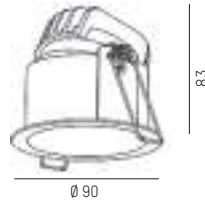

Einbaustrahler, Aluminiumdruckguss, pulverbeschichtet, zurückversetzte Lichtquelle, exkl. Konverter

Recessed spotlight, die-cast aluminium, powder-coated, recessed light source, excl. converter



PONTOS ROUND

ART. NR./CODE	LUMEN/W BEI 250mA LUMEN/W WITH 250mA		CRI>	KELVIN	Ø x ET/Ø x ID	⊕	FARBE/COLOUR	REFL.	CHF
	LED 10W	LED 15W							
305-619924w27k	805	1245	80	2700	90 x 110	83	white	24°	88,80
305-619924b27k	805	1245	80	2700	90 x 110	83	black	24°	88,80
305-619924w	840	1280	80	3000	90 x 110	83	white	24°	88,80
305-619924b	840	1280	80	3000	90 x 110	83	black	24°	88,80
305-619924w40k	840	1280	80	4000	90 x 110	83	white	24°	88,80
305-619924b40k	840	1280	80	4000	90 x 110	83	black	24°	88,80
305-619936w27k	805	1245	80	2700	90 x 110	83	white	36°	88,80
305-619936b27k	805	1245	80	2700	90 x 110	83	black	36°	88,80
305-619936w	840	1280	80	3000	90 x 110	83	white	36°	88,80
305-619936b	840	1280	80	3000	90 x 110	83	black	36°	88,80
305-619936w40k	840	1280	80	4000	90 x 110	83	white	36°	88,80
305-619936b40k	840	1280	80	4000	90 x 110	83	black	36°	88,80



KONVERTER/DRIVER



ART. NR./CODE	INFO	WATT	mA	V DC	V AC	L x B x H/L x W x H	FARBE/COLOUR	CHF
30-880006	on/off	11W/15W	250/350	44	230	156 x 43 x 30	white	15,60
24-151403	DALI	12W/17W	250/350	49	230	111 x 52 x 22	white	68,64

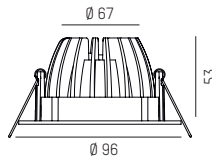

Einbaustrahler, Aluminiumdruckguss, Feinstruktur matt pulverbeschichtet, zurückversetzte Lichtquelle, exkl. Konverter

Recessed spotlight, die-cast aluminium, fine structure matt powder-coated, recessed light source, excl. light source, excl. converter



KALIO ROUND R

ART. NR./CODE	LEISTUNG/POWER	mA	LUMEN	CRI>	KELVIN	Ø x ET/Ø x ID	⊕	FARBE/COLOUR	REFL.	CHF
308-30003500	LED 8W	250	860	90	2700	96 x 83	80	white	24°	40,80
308-30003600	LED 8W	250	860	90	2700	96 x 83	80	black	24°	40,80
308-30013500	LED 8W	250	860	90	2700	96 x 83	80	white	38°	40,80
308-30003600	LED 8W	250	860	90	2700	96 x 83	80	black	38°	40,80
308-30009500	LED 8W	250	900	90	3000	96 x 83	80	white	24°	40,80
308-30009600	LED 8W	250	900	90	3000	96 x 83	80	black	24°	40,80
308-30019500	LED 8W	250	900	90	3000	96 x 83	80	white	38°	40,80
308-30019600	LED 8W	250	900	90	3000	96 x 83	80	black	38°	40,80



KONVERTER/DRIVER



ART. NR./CODE	INFO	WATT	mA	V DC	V AC	L x B x H/L x W x H	FARBE/COLOUR	CHF
30-880006	on/off	11W	250	44	230	156 x 43 x 30	white	15,60
24-151403	DALI	12W	250	49	230	111 x 52 x 22	white	68,64



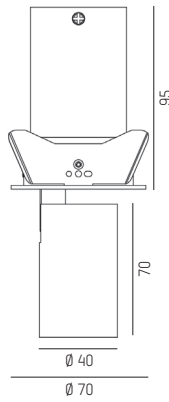

Einbaustrahler, Aluminiumdruckguss, Feinstruktur matt pulverbeschichtet, Dekorring aus Kunststoff, Strahlerkopf 90° schwenk- und 350° (35° ELIX) drehbar, exkl. Konverter

Recessed spotlight, die-cast aluminium, fine structure matt powder-coated, Decorative ring made of plastic, spotlight head 90° swivelling and 350° (35° ELIX) rotatable, excl. converter



ELIX MINI R

ART. NR./CODE	LEISTUNG/POWER	mA	LUMEN	CRI>	KELVIN	Ø x ET/Ø x ID	⊕	FARBE/COLOUR	REFL.	CHF
276-0130690342756	LED 6W	350	330	90	2700	70 x 125	64	white	34°	118,80
276-0130690342706	LED 6W	350	330	90	2700	70 x 125	64	black	34°	118,80
276-0130690343056	LED 6W	350	340	90	3000	70 x 125	64	white	34°	118,80
276-0130690343006	LED 6W	350	340	90	3000	70 x 125	64	black	34°	118,80



ELIX MINI R DEKORRING/DECORATION RING

ART. NR./CODE	INFO	Ø	FARBE/COLOUR	CHF
276-7002	Ring aus Kunststoff, gold oder weiß, werkzeuglos wechselbar (separat ordern)	38	gold	6,36
276-7003	Synthetic decoration ring, gold or white, changeable without tools (order separately)	38	white	6,36

KONVERTER/DRIVER



ART. NR./CODE	INFO	WATT	mA	V DC	V AC	L x B x H/L x W x H	FARBE/COLOUR	CHF
30-880006	on/off	15W	350	44	230	156 x 43 x 30	white	15,60
24-151403	DALI	17W	350	49	230	111 x 52 x 22	white	68,64



Dekorring
Decoration ring

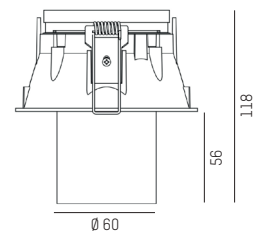

ELIX R



ART. NR./CODE	LEISTUNG/POWER	mA	LUMEN	CRI>	KELVIN	Ø x ET/Ø x ID	⊕	FARBE/COLOUR	REFL.	CHF
276-0010990332756	LED 9W	500	650	90	2700	110 x 91	102	white	33°	142,80
276-0010990332706	LED 9W	500	650	90	2700	110 x 91	102	black	33°	142,80
276-0010990333056	LED 9W	500	770	90	3000	110 x 91	102	white	33°	142,80
276-0010990333006	LED 9W	500	770	90	3000	110 x 91	102	black	33°	142,80



KONVERTER/DRIVER



ART. NR./CODE	INFO	WATT	mA	V DC	V AC	L x B x H/L x W x H	FARBE/COLOUR	CHF
30-880006	on/off	18,5W	500	44	230	156 x 43 x 30	white	15,60
24-151403	DALI	20W	500	49	230	111 x 52 x 22	white	68,64

ELIX R DEKORRING/DECORATION RING



ART. NR./CODE	INFORMATION	FARBE/COLOUR	CHF
276-7000	Ring aus Kunststoff, gold, weiß oder schwarz werkzeuglos wechselbar (separat ordern) Synthetic decoration ring, gold, white or black, changeable without tools (order separately)	■ gold	8,28
276-7001		□ white	8,28
222-A00021		■ black	8,28

ELIX R WABENRASTER/HONEY COMP LOUVRE



ART. NR./CODE	INFO	∅	FARBE/COLOUR	CHF
276-1002	Wabenraster aus Metall, werkzeuglos wechselbar. (separat ordern) Honey Comp Louvre, changeable without tools, order separately	58	■ black	5,76



50

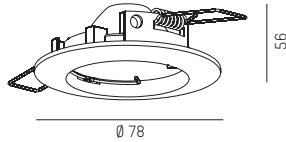

Einbaustrahler, Aluminiumdruckguss, pulverbeschichtet oder galvanisiert, starr, inkl. 30cm Kabel

Recessed spotlight, die-cast aluminium, powder-coated or galvanized, incl. 30cm cable

SERIE 146 HV GU10



ART. NR./CODE	LM/BULB	FASSUNG/SOCKET	V AC	Ø x ET/Ø x ID	Ⓢ	FARBE/COLOUR	REFL.	CHF
8-1464hv	RETROFIT	GU10	230	77 x 113	65	chrome	---	10,80
8-1466hv	RETROFIT	GU10	230	77 x 113	65	black	---	9,60
8-1467hv	RETROFIT	GU10	230	77 x 113	65	white	---	9,60
8-14646hv	RETROFIT	GU10	230	77 x 113	65	brushed nickel	---	10,80

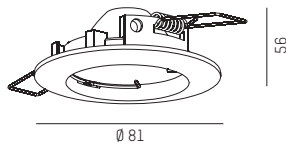

Einbaustrahler, Aluminiumdruckguss, pulverbeschichtet oder galvanisiert, starr, inkl. 30cm Kabel

Recessed spotlight, die-cast aluminium, powder-coated or galvanized, incl. 30cm cable

SERIE 223 HV GU10



ART. NR./CODE	LM/BULB	FASSUNG/SOCKET	V AC	Ø x ET/Ø x ID	Ⓢ	FARBE/COLOUR	REFL.	CHF
8-2237hv	RETROFIT	GU10	230	81 x 135	68	white	---	12,00
8-22346hv	RETROFIT	GU10	230	81 x 135	68	brushed nickel	---	14,40
8-2235hv	RETROFIT	GU10	230	81 x 135	68	black	---	12,00

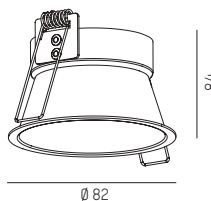

Einbaustrahler, Aluminiumdruckguss, pulverbeschichtet oder galvanisiert, starr, inkl. 30cm Kabel

Recessed spotlight, die-cast aluminium, powder-coated or galvanized, incl. 30cm cable

SERIE 3380 HV GU10



ART. NR./CODE	LM/BULB	FASSUNG/SOCKET	V AC	Ø x ET/Ø x ID	Ⓢ	FARBE/COLOUR	REFL.	CHF
8-33806hv	RETROFIT	GU10	230	81 x 157	75	black	---	16,80
8-33807hv	RETROFIT	GU10	230	81 x 157	75	white	---	16,80



LEUCHTMITTEL/LIGHT SOURCE

Weitere Leuchtmittel S./additional light sources P. 290

ART. NR./CODE	INFORMATION	CHF
30-752517	Core Pro LED Spot, GU10,5W, 827 Kelvin	7,80
30-767655	Core Pro LED Capsule, G4,2W, 827 Kelvin	12,36

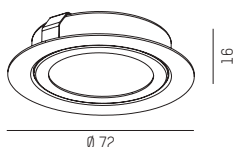

Einbaustrahler, Stahlblech, pulverbeschichtet oder galvanisiert, starr, Schutzglas matt, 1m Silikonkabel exkl. Trafo

Recessed spotlight, sheet steel, powder-coated or galvanised, fixed, protection glass matt, 1m silicone cable, excl. driver



SERIE 015 G4

ART. NR./CODE	LM/BULB	FASSUNG/SOCKET	V AC	Ø x ET/Ø x ID	⊕	FARBE/COLOUR	REFL.	CHF
8-0154	RETROFIT	G4	230	70 x 40	55	chrome	---	13,20
8-0157	RETROFIT	G4	230	70 x 40	55	white	---	12,00
8-01546	RETROFIT	G4	230	70 x 40	55	brushed nickel	---	13,20
8-0156	RETROFIT	G4	230	70 x 40	55	black	---	12,00

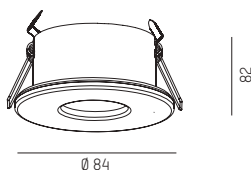

Einbaustrahler, Aluminiumdruckguss, pulverbeschichtet oder galvanisiert, starr, Schutzglas

Recessed spotlight, die-cast aluminium, powder-coated or galvanized, protection glass



SERIE 1101 HV GU10

ART. NR./CODE	LM/BULB	FASSUNG/SOCKET	V AC	Ø x ET/Ø x ID	⊕	FARBE/COLOUR	REFL.	CHF
8-1101b6hv	RETROFIT	GU10	230	84 x 120	74	black	---	22,80
8-1101b7hv	RETROFIT	GU10	230	84 x 120	74	white	---	22,80
8-1101b46hv	RETROFIT	GU10	230	84 x 120	74	brushed nickel	---	25,20





Deckeneinbauleuchte, aus Aluminium, Lichtaustritt direkt, E27 Fassung

Recessed ceiling light, made of aluminium, light emission direct, E27 socket

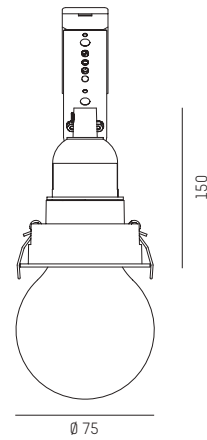

NEW

WILLI 68R



ART. NR./CODE	LM/BULB	FASSUNG/SOCKET	V AC	Ø x ET/Ø x ID	Ⓢ	FARBE/COLOUR	CHF
222-00027	RETROFIT	E27	230	75 x 160	68	□ white	40,80
222-00028	RETROFIT	E27	230	75 x 160	68	■ black	40,80



LEUCHTMITTEL/LIGHT SOURCE

Weitere Leuchtmittel S./additional light sources P. 290

ART. NR./CODE	INFORMATION	CHF
30-380035	E27/A60/7W/827	5,88



54

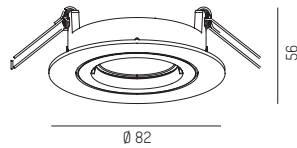

Einbaustrahler, Aluminiumdruckguss, pulverbeschichtet oder galvanisiert, inkl. 30cm Kabel

Recessed spotlight, die-cast aluminium, white or black powder-coated or galvanized, incl. 30cm cable

SERIE 68 HV GU10



ART. NR./CODE	LM/BULB	FASSUNG/SOCKET	V AC	Ø x ET/Ø x ID	⌀	FARBE/COLOUR	REFL.	CHF
8-681hv	RETROFIT	GU10	230	82 x 110	70	brass polished	---	16,80
8-684hv	RETROFIT	GU10	230	82 x 110	70	chrome	---	16,80
8-686hv	RETROFIT	GU10	230	82 x 110	70	black	---	13,20
8-687hv	RETROFIT	GU10	230	82 x 110	70	white	---	13,20
8-6846hv	RETROFIT	GU10	230	82 x 110	70	brushed nickel	---	16,80

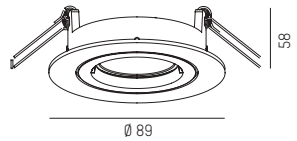

Einbaustrahler, Aluminiumdruckguss, pulverbeschichtet oder galvanisiert, inkl. 30cm Kabel mit Bajonettverschluss

Recessed spotlight, die-cast aluminium, white or black powder-coated or galvanized, incl. 30cm cable, with bayonet closure

SERIE 332 HV GU10



ART. NR./CODE	LM/BULB	FASSUNG/SOCKET	V AC	Ø x ET/Ø x ID	⌀	FARBE/COLOUR	REFL.	CHF
8-3321hv	RETROFIT	GU10	230	89 x 125	68	brass polished	---	20,40
8-3324hv	RETROFIT	GU10	230	89 x 125	68	chrome	---	20,40
8-3326hv	RETROFIT	GU10	230	89 x 125	68	black	---	16,80
8-3327hv	RETROFIT	GU10	230	89 x 125	68	white	---	16,80
8-33246hv	RETROFIT	GU10	230	89 x 125	68	brushed nickel	---	20,40

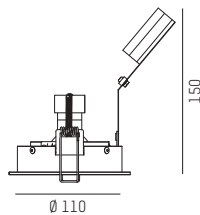

Einbaustrahler, Aluminiumdruckguss, pulverbeschichtet

Recessed spotlight, die-cast aluminium, powder-coated

NEW

QANA ROUND R



ART. NR./CODE	LM/BULB	FASSUNG/SOCKET	V AC	Ø x ET/Ø x ID	⌀	FARBE/COLOUR	REFL.	CHF
222-00015	RETROFIT	GU10	230	110 x 180	98	white	---	54,00
222-00016	RETROFIT	GU10	230	110 x 180	98	black	---	54,00



LEUCHTMITTEL/LIGHT SOURCE

Weitere Leuchtmittel S./additional light sources P. 290

ART. NR./CODE	INFORMATION	CHF
30-752517	Core Pro LED Spot, GU10,5W, 827 Kelvin	7,80







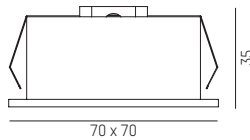

Einbaustrahler, Aluminiumdruckguss, Feinstruktur matt pulverbeschichtet, starr, zurückversetzte Lichtquelle, exkl. Konverter

Recessed spotlight, die-cast aluminium, powder-coated, fixed, with recessed light source, excl. driver



LIRO R

ART. NR./CODE	LEISTUNG/POWER	mA	LUMEN	CRI>	KELVIN	L x B x ET/L x W x ID	□	FARBE/COLOUR	REFL.	CHF
472-30003560	LED 6W	500	460	90	2700	70 x 70 x 65	62 x 62	white/black	10°	82,80
472-30003660	LED 6W	500	460	90	2700	70 x 70 x 65	62 x 62	black	10°	82,80
472-30013560	LED 6W	500	460	90	2700	70 x 70 x 65	62 x 62	white/black	30°	82,80
472-30013660	LED 6W	500	460	90	2700	70 x 70 x 65	62 x 62	black	30°	82,80
472-30009560	LED 6W	500	500	90	3000	70 x 70 x 65	62 x 62	white/black	10°	82,80
472-30009660	LED 6W	500	500	90	3000	70 x 70 x 65	62 x 62	black	10°	82,80
472-30019560	LED 6W	500	500	90	3000	70 x 70 x 65	62 x 62	white/black	30°	82,80
472-30019660	LED 6W	500	500	90	3000	70 x 70 x 65	62 x 62	black	30°	82,80



KONVERTER/DRIVER



ART. NR./CODE	INFO	WATT	mA	V DC	V AC	L x B x H/L x W x H	FARBE/COLOUR	CHF
30-880006	on/off	18,5W	500	37	230	156 x 43 x 30	white	15,60
24-151403	DALI	20W	500	49	230	111 x 52 x 22	white	68,64

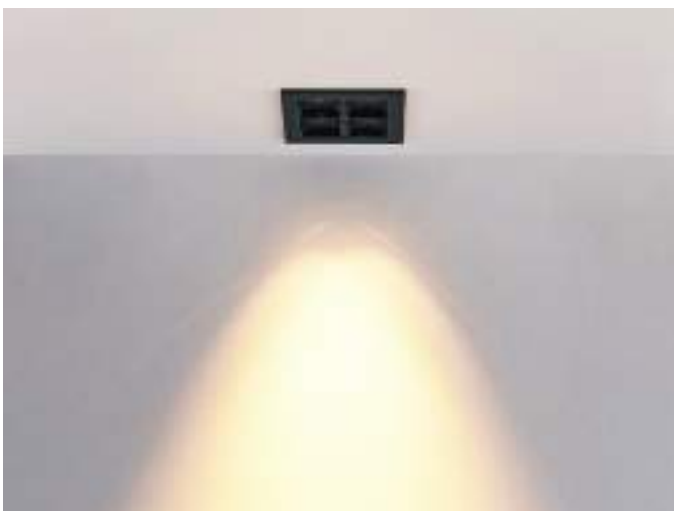



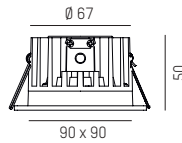

Einbaustrahler, Aluminiumdruckguss, Feinstruktur matt pulverbeschichtet, zurückversetzte Lichtquelle, exkl. Konverter

Recessed spotlight, die-cast aluminium, powder-coated, recessed light source, excl. driver

CHICCO SQUARE R



ART. NR./CODE	LEISTUNG/POWER	mA	LUMEN	CRI>	KELVIN	L x B x ET/L x W x ID	Ⓢ	FARBE/COLOUR	REFL.	CHF
308-0020790302704	LED 7W	350	530	90	2700	90 x 90 x 80	78	silver	30°	64,80
308-0020790302705	LED 7W	350	540	90	2700	90 x 90 x 80	78	white	30°	64,80
308-0020790302706	LED 7W	350	510	90	2700	90 x 90 x 80	78	black	30°	64,80
308-0020790303004	LED 7W	350	560	90	3000	90 x 90 x 80	78	silver	30°	64,80
308-0020790303005	LED 7W	350	590	90	3000	90 x 90 x 80	78	white	30°	64,80
308-0020790303006	LED 7W	350	560	90	3000	90 x 90 x 80	78	black	30°	64,80



KONVERTER/DRIVER



ART. NR./CODE	INFO	WATT	mA	V DC	V AC	L x B x H/L x W x H	FARBE/COLOUR	CHF
30-880006	on/off	15W	350	44	230	156 x 43 x 30	white	15,60
24-151403	DALI	17W	350	49	230	111 x 52 x 22	white	68,64

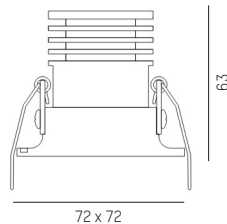

Einbaustrahler, Aluminiumdruckguss, pulverbeschichtet, zurückversetzte Lichtquelle, exkl. Konverter

Recessed spotlight, die-cast aluminium, powder-coated, with recessed light source, 2 beam angles, excl. driver

IVY SQUARE R



ART. NR./CODE	LEISTUNG/POWER	mA	LUMEN	CRI>	KELVIN	L x B x ET/L x W x ID	Ⓢ	FARBE/COLOUR	REFL.	CHF
472-0270790203005	LED 7W	200	700	90	3000	72 x 72 x 94	60	white	20°	76,80
472-0270790203006	LED 7W	200	660	90	3000	72 x 72 x 94	60	black	20°	76,80
308-0020790303004	LED 7W	200	640	90	3000	72 x 72 x 94	60	white	40°	76,80
308-0020790303005	LED 7W	200	630	90	3000	72 x 72 x 94	60	black	40°	76,80

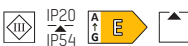

KONVERTER/DRIVER



ART. NR./CODE	INFO	WATT	mA	V DC	V AC	L x B x H/L x W x H	FARBE/COLOUR	CHF
30-880006	on/off	8,5W	200	44	230	156 x 43 x 30	white	15,60
24-151395	DALI	9W	180	50	230	108 x 52 x 22	white	69,84

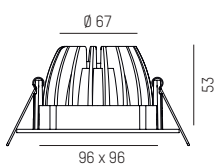

Einbaustrahler, Aluminiumdruckguss, Feinstruktur matt pulverbeschichtet, zurückversetzte Lichtquelle, exkl. Konverter

Recessed spotlight, die-cast aluminium, powder-coated, with recessed light source, excl. driver

KALIO SQUARE R



ART. NR./CODE	LEISTUNG/POWER	mA	LUMEN	CRI>	KELVIN	L x B x ET/L x W x ID	⊙	FARBE/COLOUR	REFL.	CHF
308-30023500	LED 8W	250	860	90	2700	96 x 96 x 83	80	white	24°	40,80
308-30023600	LED 8W	250	860	90	2700	96 x 96 x 83	80	black	24°	40,80
308-30033500	LED 8W	250	860	90	2700	96 x 96 x 83	80	white	38°	40,80
308-30033600	LED 8W	250	860	90	2700	96 x 96 x 83	80	black	38°	40,80
308-30029500	LED 8W	250	900	90	3000	96 x 96 x 83	80	white	24°	40,80
308-30029600	LED 8W	250	900	90	3000	96 x 96 x 83	80	black	24°	40,80
308-30039500	LED 8W	250	900	90	3000	96 x 96 x 83	80	white	38°	40,80
308-30039600	LED 8W	250	900	90	3000	96 x 96 x 83	80	black	38°	40,80



KONVERTER/DRIVER



ART. NR./CODE	INFO	WATT	mA	V DC	V AC	L x B x H/L x W x H	FARBE/COLOUR	CHF
30-880006	on/off	11W	250	44	230	156 x 43 x 30	white	15,60
24-151403	DALI	12W	250	49	230	111 x 52 x 22	white	68,64



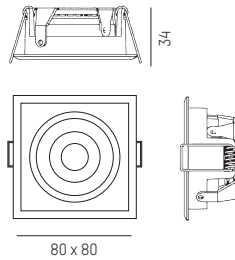

Einbaustrahler, Aluminiumdruckguss, Feinstruktur matt pulverbeschichtet, zurückver-setzte Lichtquelle, exkl. Konverter

Recessed spotlight, die- cast aluminium, powder-coated, with recessed light source, excl. driver

NEW

AGON FLAT SQUARE

ART. NR./CODE	LEISTUNG/POWER	mA	LUMEN	CRI>	KELVIN	L x B x ET/L x W x ID	Ø	FARBE/COLOUR	REFL.	CHF
222-00132	LED 5W	250	650	90	2700	80 x 80 x 64	68	white	55°	46,80
222-00133	LED 5W	250	650	90	2700	80 x 80 x 64	68	black	55°	46,80
222-00134	LED 5W	250	650	90	3000	80 x 80 x 64	68	white	55°	46,80
222-00135	LED 5W	250	650	90	3000	80 x 80 x 64	68	black	55°	46,80

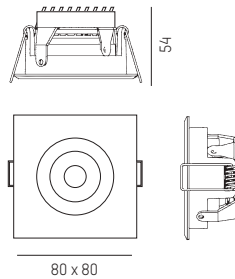

Einbaustrahler, Aluminiumdruckguss, gebürstet oder pulverbeschichtet, exkl. Konverter

Recessed spotlight, die- cast aluminium, powder-coated or brushed, excl. driver

NEW

AGON SQUARE

ART. NR./CODE	LEISTUNG/POWER	mA	LUMEN	CRI>	KELVIN	L x B x ET/L x W x ID	Ø	FARBE/COLOUR	REFL.	CHF
222-00140	LED 6/11W	250/500	415/705	90	2700	80 x 80 x 84	68	white	36°	58,80
222-00141	LED 6/11W	250/500	415/705	90	2700	80 x 80 x 84	68	black	36°	58,80
222-00142	LED 6/11W	250/500	475/830	90	3000	80 x 80 x 84	68	white	36°	58,80
222-00143	LED 6/11W	250/500	475/830	90	3000	80 x 80 x 84	68	black	36°	58,80



KONVERTER/DRIVER



ART. NR./CODE	INFO	WATT	mA	V DC	V AC	L x B x H/L x W x H	FARBE/COLOUR	CHF
30-880006	on/off	11W/18,5W	250/500	44	230	156 x 43 x 30	white	15,60
24-151403	DALI	12W/20W	250/500	49	230	111 x 52 x 22	white	68,64



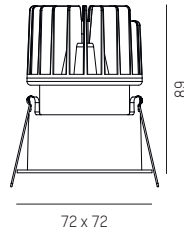

Einbaustrahler, Aluminiumdruckguss, Feinstruktur matt pulverbeschichtet, zurückversetzte Lichtquelle, exkl. Konverter

Recessed spotlight, die-cast aluminium, powder-coated, with recessed light source, excl. driver

SATOR SQUARE R



ART. NR./CODE	LEISTUNG/POWER	mA	LUMEN	CRI>	KELVIN	L x B x ET/L x W x ID	⏴	FARBE/COLOUR	REFL.	CHF
305-30023500	LED 10W	250	600	90	2700	72 x 72 x 119	68 x 68	white	24°	58,80
305-30023600	LED 10W	250	600	90	2700	72 x 72 x 119	68 x 68	black	24°	58,80
305-30029500	LED 10W	250	620	90	3000	72 x 72 x 119	68 x 68	white	24°	58,80
305-30029600	LED 10W	250	620	90	3000	72 x 72 x 119	68 x 68	black	24°	58,80



KONVERTER/DRIVER



ART. NR./CODE	INFO	WATT	mA	V DC	V AC	L x B x H/L x W x H	FARBE/COLOUR	CHF
30-880006	on/off	11W	250	44	230	156 x 43 x 30	white	15,60
24-151403	DALI	12W	250	49	230	111 x 52 x 22	white	68,64

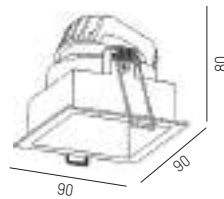

Einbaustrahler, Aluminiumdruckguss, pulverbeschichtet, zurückversetzte Lichtquelle, exkl. Konverter

Recessed spotlight, die-cast aluminium, powder-coated, with recessed light source, excl. driver

PONTOS SQUARE



ART. NR./CODE	LUMEN/W BEI 250mA	LUMEN/W BEI 350mA	CRI>	KELVIN	L x B x ET/ L x W x ID	⏴	FARBE/COLOUR	REFL.	CHF
	LUMEN/W WITH 250mA	LUMEN/W WITH 350mA							
	LED 10W	LED 15W							
305-624824w27k	810	1250	80	2700	89 x 89 x 110	78 x 78	white	24°	88,80
305-624824b27k	810	1250	80	2700	89 x 89 x 110	78 x 78	black	24°	88,80
305-624824w	870	1310	80	3000	89 x 89 x 110	78 x 78	white	24°	88,80
305-624824b	870	1310	80	3000	89 x 89 x 110	78 x 78	black	24°	88,80
305-624824w40k	870	1310	80	4000	89 x 89 x 110	78 x 78	white	24°	88,80
305-624824b40k	870	1310	80	4000	89 x 89 x 110	78 x 78	black	24°	88,80
305-624836w27k	810	1250	80	2700	89 x 89 x 110	78 x 78	white	36°	88,80
305-624836b27k	810	1250	80	2700	89 x 89 x 110	78 x 78	black	36°	88,80
305-624836w	870	1310	80	3000	89 x 89 x 110	78 x 78	white	36°	88,80
305-624836b	870	1310	80	3000	89 x 89 x 110	78 x 78	black	36°	88,80
305-624836w40k	870	1310	80	4000	89 x 89 x 110	78 x 78	white	36°	88,80
305-624836b40k	870	1310	80	4000	89 x 89 x 110	78 x 78	black	36°	88,80



KONVERTER/DRIVER



ART. NR./CODE	INFO	WATT	mA	V DC	V AC	L x B x H/L x W x H	FARBE/COLOUR	CHF
30-880006	on/off	11W/15W	250/350	44	230	156 x 43 x 30	white	15,60
24-151403	DALI	12W/17W	250/350	49	230	111 x 52 x 22	white	68,64

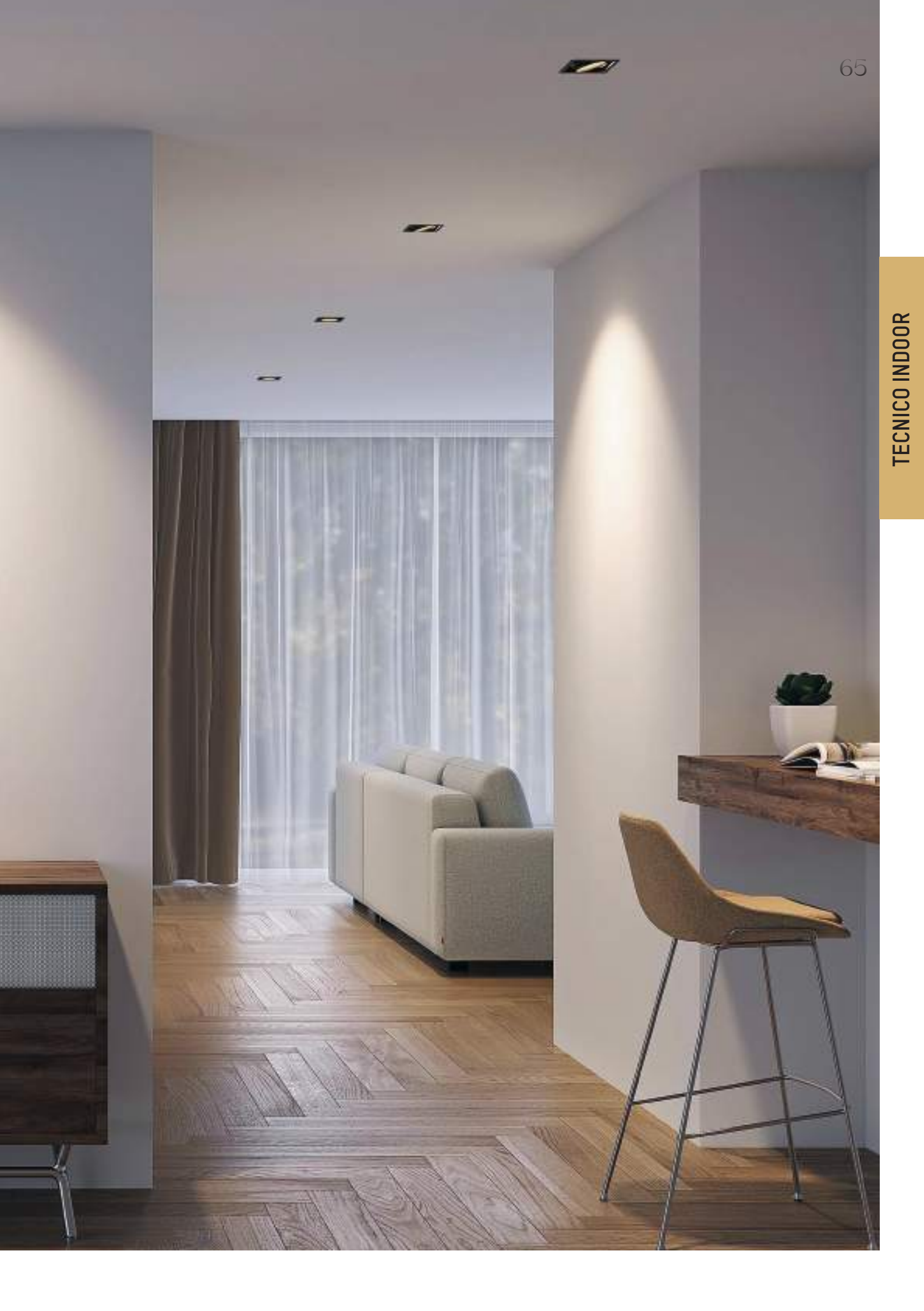

66

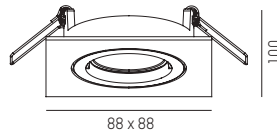

Einbaustrahler, Aluminiumdruckguss, pulverbeschichtet oder galvanisiert, inkl. 30cm Kabel, mit Bajonettverschluss

Recessed spotlight, die-cast aluminium, powder-coated or galvanized, incl. 30cm cable, with bayonet closure

SERIE 4236 HV GU10



ART. NR./CODE	LM/BULB	FASSUNG/SOCKET	V AC	L x B x ET/L x W x ID	Ø	FARBE/COLOUR	REFL.	CHF
8-42361hv	RETROFIT	GU10	230	88 x 88 x 120	68	brass polished	---	20,40
8-42364hv	RETROFIT	GU10	230	88 x 88 x 120	68	chrome	---	20,40
8-42366hv	RETROFIT	GU10	230	88 x 88 x 120	68	black	---	16,80
8-42367hv	RETROFIT	GU10	230	88 x 88 x 120	68	white	---	16,80
8-423646hv	RETROFIT	GU10	230	88 x 88 x 120	68	brushed nickel	---	20,40

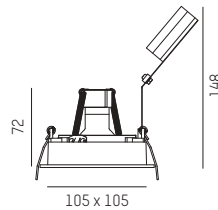

Einbaustrahler, Aluminiumdruckguss, pulverbeschichtet, rund, quadratisch und doppelte Variante

Recessed spotlight, die-cast aluminium, powder-coated, round, square and double version

NEW

QANA SQUARE R



ART. NR./CODE	LM/BULB	FASSUNG/SOCKET	V AC	L x B x ET/L x W x ID	Ø	FARBE/COLOUR	REFL.	CHF
222-00017	RETROFIT	GU10	230	105 x 105 x 178	95 x 95	white	---	57,60
222-00018	RETROFIT	GU10	230	105 x 105 x 178	95 x 95	black	---	57,60

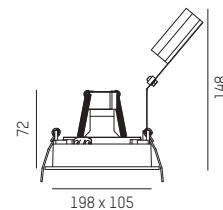

NEW

QANA DOUBLE SQUARE R



ART. NR./CODE	LM/BULB	FASSUNG/SOCKET	V AC	L x B x ET/L x W x ID	Ø	FARBE/COLOUR	REFL.	CHF
222-00019	RETROFIT	GU10	230	198 x 105 x 178	188 x 95	white	---	112,80
222-00020	RETROFIT	GU10	230	198 x 105 x 178	188 x 95	black	---	112,80



LEUCHTMITTEL/LIGHT SOURCE

Weitere Leuchtmittel S./additional light sources P. 290

ART. NR./CODE	INFORMATION	CHF
30-752517	Core Pro LED Spot, GU10,5W, 827 Kelvin	7,80









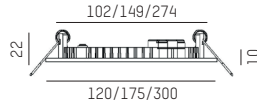

Einbauleuchte, Aluminium, weiß matt lackiert, passiv gekühlt, sehr homogene Ausleuchtung, opaler Diffusor, extrem flach, exkl. Konverter, Achtung: ca. 30mm Platz für Konverter einplanen

Recessed luminaire, aluminium, painted, passive cooling, very homogeneous illumination, opal diffuser, extremely flat, excl. driver. Attention: approx. 30 mm space needed for driver

MOON ROUND R

ART. NR./CODE	LEISTUNG/POWER	mA	LUMEN	CRI>	KELVIN	Ø x ET/Ø x ID	⌀	FARBE/COLOUR	REFL.	CHF
139-0000680003005	LED 6W	250	770	80	3000	120 x 54	110	white matt	114°	28,80
139-0000680004005	LED 6W	250	835	80	4000	120 x 54	110	white matt	114°	28,80
139-0011280003005	LED 12W	500	1730	80	3000	175 x 54	160	white matt	114°	42,00
139-0011280004005	LED 12W	500	1780	80	4000	175 x 54	160	white matt	114°	42,00
139-0021880003005	LED 17W	700	2500	80	3000	300 x 54	285	white matt	113°	82,80
139-0021880004005	LED 17W	700	2450	80	4000	300 x 54	285	white matt	113°	82,80



AUFBAUGEHÄUSE/SURFACE HOUSING

ART. NR./CODE	INFO	Ø x H/Ø x H	FARBE/COLOUR	CHF
643-1001	Aufbaugehäuse, Stahlblech, weiß matt lackiert, exkl. Leuchte und Konverter/	124 x 45	white matt	70,80
643-1002	Surface housing, sheet steel, white matt powder-coated, dimmable, excl. luminaire and driver	180 x 45	white matt	82,80
643-1003		304 x 45	white matt	130,80

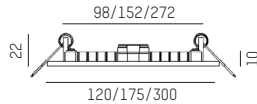

MOON SQUARE R

ART. NR./CODE	LEISTUNG/POWER	mA	LUMEN	CRI>	KELVIN	L x B x ET/L x W x ID	⌀	FARBE/COLOUR	REFL.	CHF
139-0030680003005	LED 6W	250	730	80	3000	120 x 120 x 54	105 x 105	white matt	110°	30,00
139-0030680004005	LED 6W	250	785	80	4000	120 x 120 x 54	105 x 105	white matt	110°	30,00
139-0041280003005	LED 12W	500	1640	80	3000	175 x 175 x 54	160 x 160	white matt	114°	46,80
139-0041280004005	LED 12W	500	1700	80	4000	175 x 175 x 54	160 x 160	white matt	114°	46,80
139-0051880003005	LED 17W	700	2285	80	3000	300 x 300 x 54	275 x 275	white matt	114°	94,80
139-0051880004005	LED 17W	700	2300	80	4000	300 x 300 x 54	275 x 275	white matt	114°	94,80

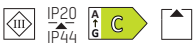

AUFBAUGEHÄUSE/SURFACE HOUSING

ART. NR./CODE	INFO	L x B x H/L x W x H	FARBE/COLOUR	CHF
643-0001	Aufbaugehäuse, Stahlblech, weiß matt lackiert, exkl. Leuchte und Konverter/	125 x 125 x 45	white matt	79,20
643-0002	Surface housing, sheet steel, white matt powder-coated, dimmable, excl. luminaire and driver	180 x 180 x 45	white matt	82,80
643-0003		305 x 305 x 45	white matt	118,80

KONVERTER/DRIVER



ART. NR./CODE	INFO	WATT	mA	V DC	V AC	FÜR/FOR	L x B x H/L x W x H	FARBE/COLOUR	CHF
30-880006	on/off	11W	250	44	230	MOON 120	156 x 43 x 30	white	15,60
30-880106	on/off	22/30W	500/700	44	230	1 MOON 175 / 1 MOON 300	156 x 43 x 30	white	16,80
24-127719	on/off	6W	250	23	230	1 MOON 120	42 x 40 x 22	black	23,76
24-151403	DALI	12/20/20W	250/500/700	49/40/28	230	1-2 MOON 120/ 1 MOON 175/300	111 x 52 x 22	white	68,64

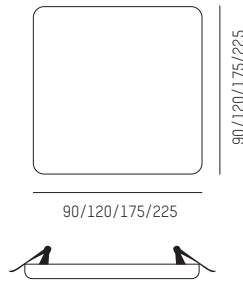

Halbeinbauleuchte, Aluminium, weiß matt lackiert, passiv gekühlt, quadratisch, sehr homogene Ausleuchtung, opaler Diffusor, 118 Grad Ausstrahlwinkel, Aufbauhöhe 20 mm, exkl. Konverter, Lichtfarbe mittels DIP-Switch einstellbar

Semi recessed luminaire, aluminium, white matt painted, passive cooling, square, very homogeneous illumination, opaldiffuser, 118° beam angle, surface height 20 mm, exkl. driver, Light colour adjustable with DIP-Switch



MAAN SQUARE

ART. NR./CODE	LEISTUNG/POWER	mA	LUMEN	CRI>	KELVIN	L x B x ET/L x W x ID	Ⓢ	CHF
139-000209201105	LED 5W	250	718/762/743	80	2700/3300/4000	90 x 90 x 50	50 - 75	22,80
139-000212201105	LED 13W	350	1888/2043/1952	80	2700/3300/4000	120 x 120 x 50	70 - 100	30,00
139-000218201105	LED 18W	500	2786/2937/2853	80	2700/3300/4000	175 x 175 x 50	70 - 150	46,80
139-000223201105	LED 32W	900	4915/5195/5062	80	2700/3300/4000	225 x 225 x 50	70 - 205	70,80

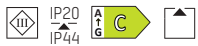

DIP-Switch

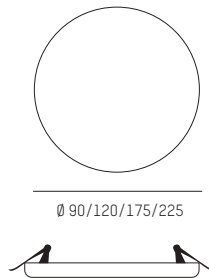
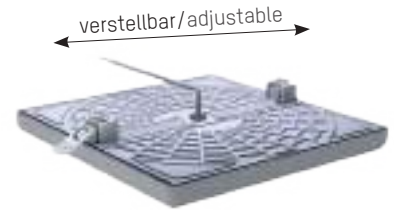

Halbeinbauleuchte, Aluminium, weiß matt lackiert, passiv gekühlt, rund, sehr homogene Ausleuchtung, opaler Diffusor, 118 Grad Ausstrahlwinkel, Aufbauhöhe 16 mm, exkl. Konverter, Lichtfarbe mittels DIP-Switch einstellbar

Semi recessed luminaire, aluminium, white matt painted, passive cooling, round, very homogeneous illumination, opaldiffuser, 118° beam angle, surface height 16 mm, exkl. driver, Light colour adjustable with DIP-Switch



MAAN ROUND

ART. NR./CODE	LEISTUNG/POWER	mA	LUMEN	CRI>	KELVIN	∅ x ET/L x W x ID	Ⓢ	CHF
139-000109201105	LED 5W	250	707/757/733	80	2700/3300/4000	90 x 50	50 - 75	22,80
139-000112201105	LED 13W	350	1846/2008/1894	80	2700/3300/4000	120 x 50	70 - 100	30,00
139-000118201105	LED 18W	500	2759/2919/2847	80	2700/3300/4000	175 x 50	70 - 150	46,80
139-000123201105	LED 32W	900	4877/5192/5047	80	2700/3300/4000	225 x 50	70 - 205	70,80



DIP-Switch



KONVERTER/DRIVER

ART. NR./CODE	INFO	WATT	mA	V DC	V AC	L x B x H/L x W x H	FARBE/COLOUR	CHF
30-880006	on/off	11W/15W/18,5W	250/350/500	44/44/37	230	156 x 43 x 30	white	15,60
24-151403	DALI	12W-20W	250-700	47-28	230	111 x 52 x 22	white	68,64
30-880206	on/off	39W	900	44	230	156 x 43 x 30	white	18,00
24-127490	DALI	16W-38W	300-1050	54-34	230	147 x 44 x 30	white	81,36



TECNICO INDOOR



HALOX-100 GEHÄUSE MIT TRAFOTUNNEL HALOX-100 HOUSING WITH TUNNEL

ART. NR./CODE	Ø	FARBE/COLOUR	CHF
113-128130	130	grey	53,40



HALOX-100 GEHÄUSE/HOUSING

ART. NR./CODE	Ø	FARBE/COLOUR	CHF
113-128100	130	grey	21,60



HALOX-100 UNIVERSALFRONTTEIL HALOX-100 UNIVERSAL FRONT PARTS

ART. NR./CODE	Ø	FARBE/COLOUR	CHF
113-128111	max. 100	grey	41,88



HALOX-100 UNIVERSALFRONTTEIL HALOX-100 UNIVERSAL FRONT PARTS

ART. NR./CODE	Ø	FARBE/COLOUR	CHF
113-128110	max. 100	grey	15,24



HALOX-100 FRONTTEILE HALOX 100 FRONT PARTS

ART. NR./CODE	Ø	FARBE/COLOUR	CHF
113-128108	68 x 68 (Leuchtenblende/Luminaire cover min. 75 x 75)	grey	13,32
113-128109	75 x 75 (Leuchtenblende/Luminaire cover min. 82 x 82)	grey	13,32

Einbauhöhe inkl. Frontteil 120 mm, 4 Schlagkupplungen M20/25, Kombinationseinführung mit Rohrein-
führungsbegrenzung zur Ver-
meidung innerer Rohrkürzung, für
Leuchten mit Einbaudurchmes-
ser 0-100mm, max. Einbauhöhe
Leuchte 110 mm, Lampenleistung
LED max. 20 W, Lampenleistung
NV/HV/TC max. 50W, Tunnel für
Aufnahme von Betriebsgeräten
in entsprechender Größe (Tunnel
LxBxH = 190x140x85mm)

Installation height including front
part 120 mm, 4 impact couplings
M20/25, combination entry with
conduit entry restriction to avo-
id inner conduit shortening, for
lights with an installation diam-
eter of 0-100mm, max. light instal-
lation height 110 mm, LED lamp
power max 20W, lamp power NV/
HV/TC max. 50W, tunnel for the
installation of control gear of the
appropriate size (tunnel LxWxH =
190x140x85mm)

Einbauhöhe inkl. Frontteil 120
mm, 2 Schlagkupplungen M20/25,
Kombinationseinführung mit Rohr-
einführungsbegrenzung zur Ver-
meidung innerer Rohrkürzung, für
Leuchten mit Einbaudurchmes-
ser 0-100mm, max. Einbauhöhe
Leuchte 110 mm, Lampenleistung
LED max. 20 W, Lampenleistung
NV/HV/TC max. 50W

Installation height including front
part 120 mm, 2 impact couplings
M20/25, combination entry with
conduit entry limiter to avoid in-
ner conduit shortening, for
lights with an installation diam-
eter of 0-100mm, max. light instal-
lation height 110 mm, lamp power
LED max. 20 W, lamp power NV/
HV/TC max. 50W

Variabler Deckenauslass mit Mine-
ralfaserplatte, Deckenauslass bis
Ø max. 100 mm stufenlos möglich,
zeitsparend ohne weitere Nach-
arbeiten evtl. Oberfläche glätten

variable ceiling exit with mineral
fiber board, ceiling outlet up to
Ø max. 100 mm infinitely variab-
le, time-saving without further
reworking smooth the surface if
necessary

variabler Deckenauslass für Ø von
0-100 mm

variable ceiling exit for Ø from
0-100 mm

HALOX Frontteil für quadratischen
Deckenauslass - verschiedene
Ausführungen für entsprechende
Außenabmessungen

HALOX front part for square cei-
ling exit - different versions for
appropriate external dimensions





HALOX Frontteil für quadratischen Deckenauslass - verschiedene Ausführungen für entsprechende Außenabmessungen

HALOX front part for square ceiling exit - different versions for appropriate external dimensions

HALOX-100 FRONTTEILE HALOX 100 FRONT PARTS



ART. NR./CODE	Ø	FARBE/COLOUR	CHF
113-128101	68 (Leuchtenblende/Luminaire cover min. 75)	grey	13,32
113-128102	75 (Leuchtenblende/Luminaire cover min. 82)	grey	13,32
113-128103	80 (Leuchtenblende/Luminaire cover min. 87)	grey	13,32
113-128104	85 (Leuchtenblende/Luminaire cover min. 92)	grey	13,32
113-128106	95 (Leuchtenblende/Luminaire cover min. 102)	grey	13,32
113-128107	100 (Leuchtenblende/Luminaire cover min. 107)	grey	13,32

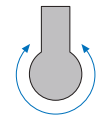

Gehäuse um 360° drehbar
Housing 360° turnable

BETON-EINBAUGEHÄUSE HALOX-100 FÜR ORTBETON HALOX 100 CONCRETE HOUSING FOR ON-SITE MIXED CONCRETE INFORMATION

Für Halogenleuchten (Hochvolt und Niedervolt) und Lautsprecher in Ortbeton ab einer Deckenstärke von 160 mm steht Ihnen mit HaloX-0 ein umfangreiches Gehäusesystem zur Verfügung. Runde und quadratische Frontteile, Frontteile mit Mineralfaserplatten, Trafo-Tunnel und Zubehör ermöglichen vielfältige Einbaumöglichkeiten.

For halogen luminaires (high voltage and low voltage) and loudspeakers in on-site concrete, from a ceiling thickness of 60 mm, HaloX offers you a comprehensive housing system. Round and square front parts, front parts with mineral fibreboards, transformer tunnels and accessories enable a wide range of installation options.

ABMESSUNGEN & INFO MEASUREMENTS & INFO INFORMATION

- Starre und kardanbefestigte Leuchten
- Lampenleistung max. 50 W
- Nur geprüfte (DIN VDE 0711/ EN 60598) sowie mit oder gekennzeichnete Leuchten verwenden.

- fixed and gimbal-mounted luminaires
- lamp power max. 50 W
- Use only tested (DIN VDE 0711 / EN60598) as well as with or marked luminaires.

FRONTTEIL DECKENAUSLASS FRONT PARTSCEILING EXIT

Ø 68 - 100

Ø 68 x 68 mm

Ø 75 x 75 mm

MIN. Ø LEUCHTENBLENDE MIN. Ø LUMINAIRE COVERING

75 - 107

75 x 75 mm

82 x 82 mm

UNIVERSAL-FRONTTEIL/UNIVERSAL FRONT PART

mit variablem Öffnungsmaß (DA) bis Ø 100 mm
with flexible ceiling opening (cutout) diam. 40 - 100mm

UNIVERSAL-FRONTTEIL MIT MINERalfaserplatte UNIVERSAL FRONT PART WITH MINERAL FIBREBOARD

mit variablem Öffnungsmaß (DA) bis Ø 100 mm
with flexible ceiling opening (cutout) diam. 40 - 100mm

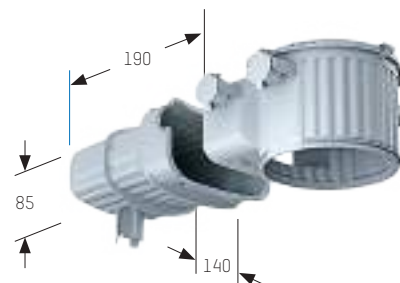



HALOX-180 GEHÄUSE MIT TRAFOTUNNEL HALOX-180 HOUSING WITH TUNNEL

ART. NR./CODE	Ø	FARBE/COLOUR	CHF
113-128230	210	■ grey	88,92



HALOX-180 GEHÄUSE/HOUSING

ART. NR./CODE	Ø	FARBE/COLOUR	CHF
113-128200	210	■ grey	43,20



HALOX-180 UNIVERSALFRONTTEIL UNIVERSAL FRONT PARTS

ART. NR./CODE	Ø	FARBE/COLOUR	CHF
113-128211	max. 180	■ grey	50,88



HALOX-180 UNIVERSALFRONTTEIL HALOX-180 UNIVERSAL FRONT PARTS

ART. NR./CODE	Ø	FARBE/COLOUR	CHF
113-128210	max. 180	■ grey	36,84



HALOX-180 FRONTTEILE HALOX 180 FRONT PARTS

ART. NR./CODE	Ø	FARBE/COLOUR	CHF
113-128201	100 (Leuchtenblende/Luminaire cover min. 107)	■ grey	21,00
113-128202	110 (Leuchtenblende/Luminaire cover min. 117)	■ grey	21,00
113-128203	125 (Leuchtenblende/Luminaire cover min. 132)	■ grey	21,00
113-128204	145 (Leuchtenblende/Luminaire cover min. 152)	■ grey	21,00
113-128206	160 (Leuchtenblende/Luminaire cover min. 167)	■ grey	21,00

Einbauhöhe inkl. Frontteil 120 mm, 4 Schlagkupplungen M20/25, Kombinationseinführung mit Rohrein-
führungsbegrenzung zur Vermeidung innerer Rohrkürzung, für Leuchten mit Einbaudurchmesser 0-180mm, max. Einbauhöhe Leuchte 110 mm, Lampenleistung LED max. 35 W, Lampenleistung NV/HV/TC max. 75W, Tunnel für Aufnahme von Betriebsgeräten in entsprechender Größe (Tunnel L x B x H = 190 x 140 x 85mm)

Installation height including front part 120 mm, 4 impact couplings M20/25, combination entry with conduit entry restriction to avoid inner conduit shortening, for lights with an installation diameter of 0-180mm, max. light installation height 110 mm, LED lamp power max 35W, lamp power NV/HV/TC max. 75W, tunnel for the installation of control gear of the appropriate size (tunnel L x W x H = 190 x 140 x 85mm)

Einbauhöhe inkl. Frontteil 120 mm, 2 Schlagkupplungen M20/25, Kombinationseinführung mit Rohrein-
führungsbegrenzung zur Vermeidung innerer Rohrkürzung, für Leuchten mit Einbaudurchmesser 0-180mm, max. Einbauhöhe Leuchte 110 mm, Lampenleistung LED max. 35 W, Lampenleistung NV/HV/TC max. 75W

Installation height including front part 120 mm, 2 impact couplings M20/25, combination entry with conduit entry limiter to avoid inner conduit shortening, for lights with an installation diameter of 0-180mm, max. light installation height 110 mm, lamp power LED max. 35 W, lamp power NV/HV/TC max. 75W

Variabler Deckenauslass mit Mineralfaserplatte, Deckenauslass bis Ø max. 180 mm stufenlos möglich, zeitsparend ohne weitere Nacharbeiten evtl. Oberfläche glätten

variable ceiling exit with mineral fiber board, ceiling outlet up to Ø max. 180 mm infinitely variable, time-saving without further reworking smooth the surface if necessary

variabler Deckenauslass für Ø von 0-180 mm

variable ceiling exit for Ø from 0-180 mm

HALOX Frontteil für quadratischen Deckenauslass - verschiedene Ausführungen für entsprechende Außenabmessungen

HALOX front part for square ceiling exit - different versions for appropriate external dimensions



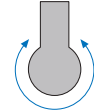
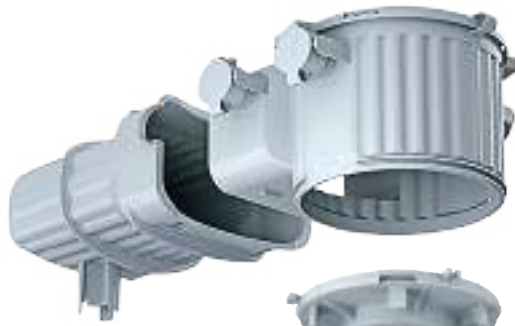

Gehäuse um 360° drehbar
Housing 360° turnable

**BETON-EINBAUGEHÄUSE HALOX-180 FÜR ORTBETON
HALOX 180 CONCRETE HOUSING FOR ON-SITE
MIXED CONCRETE**

INFORMATION

Für Leuchten und Lautsprecher in Ortbeton steht Ihnen mit HaloX ein umfangreiches Gehäusesystem zur Verfügung. Runde Frontteile, Frontteile mit Mineralfaserplatten, Trafo-Tunnel und Zubehör ermöglichen vielfältige Einbaumöglichkeiten.

For halogen luminaires (high voltage and low voltage) and loudspeakers in on-site concrete, from a ceiling thickness of 60 mm, HaloX offers you a comprehensive housing system. Round and square front parts, front parts with mineral fibreboards, transformer tunnels and accessories enable a wide range of installation options.

FRONTTEIL DECKENAUSLASS FRONT PARTS CEILING EXIT	MIN. Ø LEUCHTENBLENDE MIN. Ø LUMINAIRE COVERING
Ø 100 - 180	Ø 107 - 187

UNIVERSAL-FRONTTEIL/UNIVERSAL FRONT PART
mit variablem Öffnungsmaß (DA) bis Ø 180 mm
with flexible ceiling opening (cutout) diam. 40 - 180mm

**UNIVERSAL-FRONTTEIL MIT MINERALFASERPLATTE
UNIVERSAL FRONT PART WITH MINERAL FIBREBOARD**
mit variablem Öffnungsmaß (DA) bis Ø 180 mm
with flexible ceiling opening (cutout) diam. 40 - 180mm

**ABMESSUNGEN & INFO
MEASUREMENTS & INFO**

INFORMATION

- Starre und kardanbefestigte Leuchten
- Lampenleistung max. 75 W
- Nur geprüfte (DIN VDE 0711/ EN 60598) sowie mit oder gekennzeichnete Leuchten verwenden.
- fixed and gimbal-mounted luminaires
- lamp power max. 75W
- Use only tested (DIN VDE 0711 / EN60598) as well as with or marked luminaires.

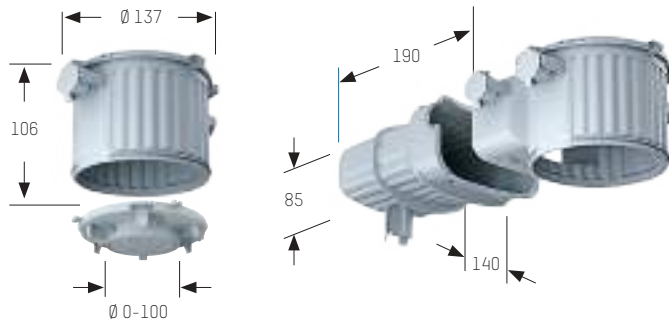

Ohne Abdeckung aus verzinktem Blech, nicht für Sichtbeton geeignet, je eine Schlaucheinführung DM 20mm und 25mm links und rechts, Abdeckung separat ordern

Without cover made of galvanized sheet metal, not suitable for fair-faced concrete, one hose entry each DM20mm and 25mm left and right, order cover separately



Ohne Abdeckung aus verzinktem Blech, nicht für Sichtbeton geeignet, je eine Schlaucheinführung DM 20mm und 25mm links und rechts, Abdeckung separat ordern

Without cover made of galvanized sheet metal, not suitable for fair-faced concrete, one hose entry each DM20mm and 25mm left and right, order cover separately

**UNIVERSAL BETONEINBAUGEHÄUSE
UNIVERSAL CONCRETE HOUSING**



ART. NR./CODE	L x B x H/L x W x H	CHF
332-1001	170 x 170 x 116	57,24
332-2001	450 x 303 x 136	100,44

**ABDECKUNG RUND
COVER ROUND**



ART. NR./CODE	FÜR/FOR	LxBxH/LxWxH	Ø	CHF
332-3r170	SPEAKER 1, ENERGY 2180	300 x 250 x 16	170	49,56

DECKENAUFBAULEUCHTEN SURFACE LUMINAIRES





80



Runde LED Aufbauleuchte aus Aluminium, matt Feinstruktur pulverbeschichtet, inkl. Konverter

LED surface mounted luminaire, aluminium, powder-coated, fixed, incl. driver

AEON ROUND SMALL



ART. NR./CODE	LEISTUNG/POWER	LUMEN	CRI>	KELVIN	Ø x H	FARBE/COLOUR	REFL.	CHF
305-602527w	SYS 6W	475	80	2700	80 x 95	white	45°	112,80
305-602527b	SYS 6W	475	80	2700	80 x 95	black	45°	112,80
305-602530w	SYS 6W	475	80	3000	80 x 95	white	45°	112,80
305-602530b	SYS 6W	475	80	3000	80 x 95	black	45°	112,80



Runde LED Aufbauleuchte aus Aluminium, matt Feinstruktur pulverbeschichtet, inkl. Konverter, DALI dimmbar

Round LED surface-mounted light made of aluminium, matt fine structure powder-coated, incl. converter, DALI dimmable

AEON ROUND BIG



ART. NR./CODE	LEISTUNG/POWER	LUMEN	CRI>	KELVIN	Ø x H	FARBE/COLOUR	REFL.	CHF
305-604527wddd	SYS 15W	1015	80	2700	125 x 158	white	50°	334,80
305-604527bddd	SYS 15W	1015	80	2700	125 x 158	black	50°	334,80
305-604530wddd	SYS 15W	1160	80	3000	125 x 158	white	50°	310,80
305-604530bddd	SYS 15W	1160	80	3000	125 x 158	black	50°	310,80







Quadratische LED Aufbauleuchte aus Aluminium, matt Feinstruktur pulverbeschichtet, inkl. Konverter

LED surface mounted luminaire, aluminium, powder-coated, fixed, incl. driver

AEON SQUARE SMALL



ART. NR./CODE	LEISTUNG/POWER	LUMEN	CRI>	KELVIN	L x B x H/L x W x H	FARBE/COLOUR	REFL.	CHF
305-602427w	SYS 6W	430	80	2700	80 x 80 x 95	white	45°	112,80
305-602427b	SYS 6W	430	80	2700	80 x 80 x 95	black	45°	112,80
305-602430w	SYS 6W	495	80	3000	80 x 80 x 95	white	45°	112,80
305-602430b	SYS 6W	495	80	3000	80 x 80 x 95	black	45°	112,80



IP20



Quadratische LED Aufbauleuchte aus Aluminium, matt Feinstruktur pulverbeschichtet, inkl. Konverter, DALI dimmbar

LED surface mounted luminaire, aluminium, powder-coated, fixed, incl. driver, DALI dimmable

AEON SQUARE BIG



ART. NR./CODE	LEISTUNG/POWER	LUMEN	CRI>	KELVIN	L x B x H/L x W x H	FARBE/COLOUR	REFL.	CHF
305-604427wddd	SYS 15W	1005	80	2700	120 x 120 x 158	white	50°	310,80
305-604427bddd	SYS 15W	1005	80	2700	120 x 120 x 158	black	50°	310,80
305-604430wddd	SYS 15W	1180	80	3000	120 x 120 x 158	white	50°	310,80
305-604430bddd	SYS 15W	1180	80	3000	120 x 120 x 158	black	50°	334,80



IP20







Aufbauleuchte, Aluminiumdruckguss, Feinstruktur pulverbeschichtet, inkl. Konverter

Surface mounted luminaire, die-cast aluminium, powder-coated, incl. driver

POLUS



ART. NR./CODE	LEISTUNG/POWER	LUMEN	CRI>	KELVIN	L x B x H/L x W x H	FARBE/COLOUR	REFL.	CHF
276-0091190003005	SYS 12W	606	90	3000	105 x 105 x 105	white/white	---	210,00
276-0091190003063	SYS 12W	580	90	3000	105 x 105 x 105	black/gold	---	214,80



Aufbauleuchte, AC-LED, Aluminium, Feinstruktur pulverbeschichtet, mit geschlossenem opalem Acryldiffuser, homogene Lichtverteilung

Surface mounted luminaire, AC-LED, aluminium, powder-coated, with closed opal acrylic diffuser, homogeneous light distribution

UP AC



ART. NR./CODE	LEISTUNG/POWER	LUMEN	CRI>	KELVIN	L x B x H/L x W x H	FARBE/COLOUR	REFL.	CHF
472-0501090002705	SYS 10W	576	90	2700	100 x 100 x 63	white	---	238,80
472-0501090002706	SYS 10W	461	90	2700	100 x 100 x 63	black	---	238,80
472-0501090002704	SYS 10W	486	90	2700	100 x 100 x 63	silver	---	238,80
472-0501090003005	SYS 10W	640	90	3000	100 x 100 x 63	white	---	238,80
472-0501090003006	SYS 10W	515	90	3000	100 x 100 x 63	black	---	238,80
472-0501090003004	SYS 10W	540	90	3000	100 x 100 x 63	silver	---	238,80



LED Aufbauleuchte aus Aluminium, pulverbeschichtet, zurückversetzte Lichtquelle, inkl. Konverter

LED surface mounted luminaire, aluminium, powder-coated, with recessed light source, incl. driver

LIRO SD



ART. NR./CODE	LEISTUNG/POWER	LUMEN	CRI>	KELVIN	L x B x H/L x W x H	FARBE/COLOUR	REFL.	CHF
472-20073560	SYS 10W	620	90	2700	60 x 60 x 70	white/black	10°	154,80
472-20073660	SYS 10W	620	90	2700	60 x 60 x 70	black	10°	154,80
472-20083560	SYS 10W	620	90	2700	60 x 60 x 70	white/black	30°	154,80
472-20083660	SYS 10W	620	90	2700	60 x 60 x 70	black	30°	154,80
472-20079560	SYS 10W	650	90	3000	60 x 60 x 70	white/black	10°	154,80
472-20079660	SYS 10W	650	90	3000	60 x 60 x 70	black	10°	154,80
472-20089560	SYS 10W	650	90	3000	60 x 60 x 70	white/black	30°	154,80
472-20089660	SYS 10W	650	90	3000	60 x 60 x 70	black	30°	154,80







Aufbauleuchte, Aluminiumdruckguss, matt Feinstruktur pulverbeschichtet, zylindrisch, Acryldiffusor matt satiniert, inkl. Konverter

Surface mounted luminaire, die-cast aluminium, powder-coated, cylindrical, acrylic diffuser matt satined, incl. driver

CARMi



ART. NR./CODE	LEISTUNG/POWER	LUMEN	CRI>	KELVIN	L x H	FARBE/COLOUR	REFL.	CHF
472-1227050	SYS 13W	550	90	2700	140 x 55	white	---	238,80
472-1227060	SYS 13W	455	90	2700	140 x 55	black	---	238,80
472-12270630	SYS 13W	540	90	2700	140 x 55	black/gold	---	238,80
472-1229050	SYS 13W	615	90	3000	140 x 55	white	---	238,80
472-1229060	SYS 13W	510	90	3000	140 x 55	black	---	238,80
472-12290630	SYS 13W	540	90	3000	140 x 55	black/gold	---	238,80





Aufbauleuchte, Aluminiumdruckguss, matt Feinstruktur pulverbeschichtet, zylindrisch, Acryldiffusor matt satiniert, inkl. Konverter

Surface mounted luminaire, die-cast aluminium, powder-coated, cylindrical, acrylic diffuser matt satined, incl. driver

ARIK SHORT



ART. NR./CODE	LEISTUNG/POWER	LUMEN	CRI>	KELVIN	Ø x H	FARBE/COLOUR	REFL.	CHF
472-260029	SYS 11W	744	90	3000	99 x 70	white	---	190,80
472-260030	SYS 11W	744	90	3000	99 x 70	black	---	190,80





Deckenaufbauleuchte, Aluminium, pulverbeschichtet, direkt strahlend, opaler Diffuser, Lichtfarbe einstellbar mittels Schalter auf LED-Board, inkl. Konverter

Ceiling luminaire, aluminium, powder coated, direct beam, opal diffuser, Light colour is adjustable with a switch on the LED board, incl. driver

DESCO M



ART. NR./CODE	LEISTUNG/POWER	LUMEN	CRI>	KELVIN	Ø x H	FARBE/COLOUR	REFL.	CHF
341-r2419150	SYS 15W	1005/983/972	90	2700/3000/4000	240 x 50	white	113°	226,80
341-r2419160	SYS 15W	1005/983/972	90	2700/3000/4000	240 x 50	black	113°	226,80



Deckenaufbauleuchte, Aluminium, pulverbeschichtet, direkt strahlend, opaler Diffuser, Lichtfarbe einstellbar mittels Schalter auf LED-Board, inkl. Konverter

Ceiling luminaire, aluminium, powder coated, direct beam, opal diffuser, Light colour is adjustable with a switch on the LED board, incl. driver

DESCO L



ART. NR./CODE	LEISTUNG/POWER	LUMEN	CRI>	KELVIN	Ø x H	FARBE/COLOUR	REFL.	CHF
341-r3319150	SYS 21W	1526/1567/1554	90	2700/3000/4000	330 x 74	white	113°	286,80
341-r3319160	SYS 21W	1526/1567/1554	90	2700/3000/4000	330 x 74	black	113°	286,80







Wand- und Deckenaufbauleuchte, Aluminiumdruckguss, stufenlos dimmbar, starr oder dreh- und schwenkbar, Phasenabschnitt dimmbar

Surface-mounted wall and ceiling light, die-cast aluminium, stepless dimmable, fixed or rotatable and swivelling, phase cut dimming

NEW

MAG SDI



ART. NR./CODE	LEISTUNG/POWER	LUMEN	CRI>	KELVIN	Ø x H	FARBE/COLOUR	REFL.	CHF
222-00005	SYS 16W	1180	90	2700	120 x 69	white	40°	238,80
222-00006	SYS 16W	1180	90	2700	120 x 69	black	40°	238,80
222-00144	SYS 16W	1280	90	3000	120 x 69	white	40°	238,80
222-00145	SYS 16W	1280	90	3000	120 x 69	black	40°	238,80



NEW

MAG SD TURN



ART. NR./CODE	LEISTUNG/POWER	LUMEN	CRI>	KELVIN	Ø x H	FARBE/COLOUR	REFL.	CHF
222-00007	SYS 13W	940	90	2700	120 x 81	white	40°	262,80
222-00008	SYS 13W	940	90	2700	120 x 81	black	40°	262,80
222-00146	SYS 16W	1040	90	3000	120 x 81	white	40°	262,80
222-00147	SYS 16W	1040	90	3000	120 x 81	black	40°	262,80





MAGIS MINI SD



ART. NR./CODE	LEISTUNG/POWER	LUMEN	CRI>	KELVIN	Ø x H	FARBE/COLOUR	REFL.	CHF
222-00040	SYS 12W	800	90	2700	75 x 92	white	46°	214,80
222-00041	SYS 12W	800	90	3000	75 x 92	white	46°	214,80
222-00042	SYS 12W	800	90	2700	75 x 92	black	46°	214,80
222-00043	SYS 12W	800	90	3000	75 x 92	black	46°	214,80

MAGIS MINI DOUBLE SD



ART. NR./CODE	LEISTUNG/POWER	LUMEN	CRI>	KELVIN	Ø x H	FARBE/COLOUR	REFL.	CHF
222-00044	SYS 20W	1500	90	2700	160 x 75 x 92	white	46°	322,80
222-00045	SYS 20W	1620	90	3000	160 x 75 x 92	white	46°	322,80
222-00046	SYS 20W	1500	90	2700	160 x 75 x 92	black	46°	322,80
222-00047	SYS 20W	1620	90	3000	160 x 75 x 92	black	46°	322,80

Aufbauleuchte, Aluminiumdruckguss, pulverbeschichtet, Dekorring wechselbar, beiliegender Austauschreflektor, Ausstrahlwinkel 23/34/46°



Surface-mounted luminaire, die-cast aluminium, powder-coated, replaceable decorative ring, enclosed replacement reflector, 23/34/46° beam angle



Dekorring
Decoration ring



MAGIS MINI DEKORRING/DECORATION RING

ART. NR./CODE	FARBE/COLOUR	CHF
276-7007	 gold	12,12
276-7008	 white	12,12
276-7009	 black	12,12



MAGIS MINI TAUSCHREFLEKTOR/ REPLACEMENT REFLECTORREFLECTOR

ART. NR./CODE	REF	CHF
276-7012	23°	9,48
276-7013	34°	9,48





MAGIS SD



ART. NR./CODE	LEISTUNG/POWER	LUMEN	CRI>	KELVIN	Ø x H	FARBE/COLOUR	REFL.	CHF
222-00029	SYS 16W	1090	90	2700	100 x 103	white	36°	310,80
222-00030	SYS 16W	1150	90	3000	100 x 103	white	36°	310,80
222-00031	SYS 16W	1090	90	2700	100 x 103	black	36°	310,80
222-00032	SYS 16W	1150	90	3000	100 x 103	black	36°	310,80

MAGIS DOUBLE SD



ART. NR./CODE	LEISTUNG/POWER	LUMEN	CRI>	KELVIN	Ø x H	FARBE/COLOUR	REFL.	CHF
222-00033	SYS 29W	1940	90	2700	212 x 100 x 103	white	36°	478,80
222-00034	SYS 29W	2110	90	3000	212 x 100 x 103	white	36°	478,80
222-00035	SYS 29W	1940	90	2700	212 x 100 x 103	black	36°	478,80
222-00036	SYS 29W	2110	90	3000	212 x 100 x 103	black	36°	478,80



Dekorring
Decoration ring

Aufbauleuchte, Aluminiumdruckguss, pulverbeschichtet, Dekorring wechselbar, beiliegender Austauschreflektor, Ausstrahlwinkel 20/30/36°

Surface-mounted luminaire, die-cast aluminium, powder-coated, replaceable decorative ring, enclosed replacement reflector, 20/30/36° beam angle



MAGIS DEKORRING/DECORATION RING

ART. NR./CODE	FARBE/COLOUR	CHF
276-7004	gold	14,54
276-7005	white	14,54
276-7006	black	14,54



MAGIS TAUSCHREFLEKTOR/ REPLACEMENT REFLECTOR

ART. NR./CODE	REF	CHF
276-7010	20°	19,08
276-7011	30°	19,08









Aufbaustrahler, Aluminiumdruckguss, Feinstruktur matt pulverbeschichtet, Dekorring aus Kunststoff schwarz, Strahlerkopf 90° schwenk- und 355° drehbar, Wand- oder Deckenmontage, inkl. Konverter

Surface mounted spotlight, die-cast aluminium, powder-coated, decoration ring in black synthetic, head 90° tilting and 355° swiveling, wall or ceiling mounting, incl. driver



MISSOR I

ART. NR./CODE	LEISTUNG/POWER	LUMEN	CRI>	KELVIN	L x B x H/L x W x H	FARBE/COLOUR	REFL.	CHF
276-06290560	SYS 12W	660	90	3000	175 x 60 x 148	white	33°	214,80
276-0629060	SYS 12W	660	90	3000	175 x 60 x 148	black	33°	214,80



Aufbaustrahler, 2 flammig, Aluminiumdruckguss, Feinstruktur matt pulverbeschichtet, Dekorring aus Kunststoff schwarz, Strahlerkopf 90° schwenk- und 355° drehbar, Wand- oder Deckenmontage, inkl. Konverter

Surface mounted spotlight, 2-spots, die-cast aluminium, powder-coated, decoration ring in black synthetic, head 90° tilting and 355° swiveling, wall or ceiling mounting, incl. driver



MISSOR II

ART. NR./CODE	LEISTUNG/POWER	LUMEN	CRI>	KELVIN	L x B x H/L x W x H	FARBE/COLOUR	REFL.	CHF
276-07290560	SYS 21W	1340	90	3000	336 x 60 x 148	white	33°	358,80
276-0729060	SYS 21W	1340	90	3000	336 x 60 x 148	black	33°	358,80



Dekorring
Decoration ring

MISSOR DEKORRING/DECORATION RING

ART. NR./CODE	∅	FARBE/COLOUR	CHF
276-7000	60	gold	8,28
276-7001	60	white	8,28
222-A00021	60	black	8,28

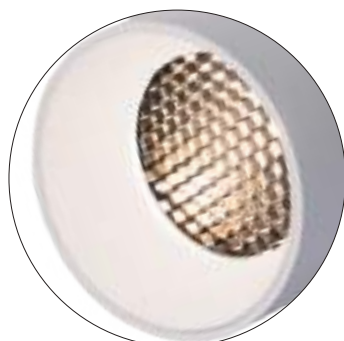

**MISSOR WABENRASTER/
HONEY COMB LOUVRE**



ART. NR./CODE	∅	FARBE/COLOUR	CHF
276-1002	60	black	5,76





NEW

Aufbauleuchte, Aluminiumdruckguss, pulverbeschichtet, 3 Ausführungen

Surface-mounted luminaire, die-cast aluminium, powder-coated, 3 versions



Dekoring/
decoration ring

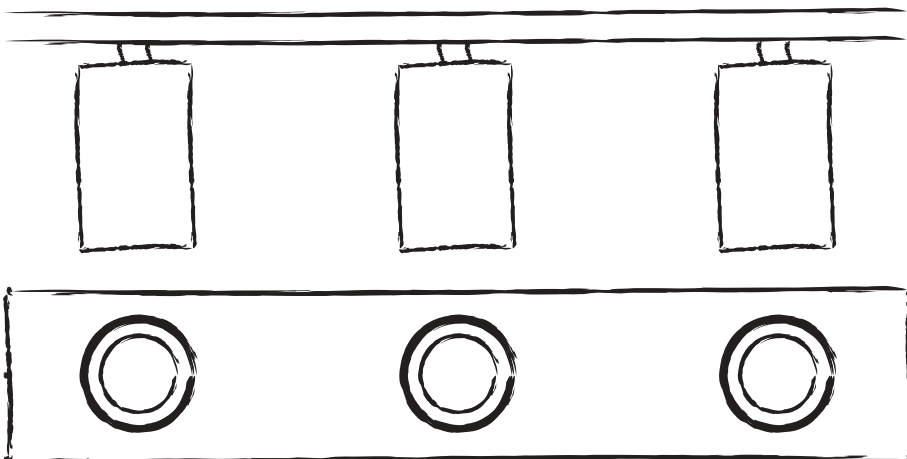



MISSOR I SD GU10

ART. NR./CODE	LM/BULB	FASSUNG/SOCKET	V AC	L x B x H/L x W x H	FARBE/COLOUR	CHF
222-00021	RETROFIT	GU10	230	110 x 90 x 125	☐ white	58,80
222-00022	RETROFIT	GU10	230	110 x 90 x 125	■ black	58,80



MISSOR II SD GU10

ART. NR./CODE	LM/BULB	FASSUNG/SOCKET	V AC	L x B x H/L x W x H	FARBE/COLOUR	CHF
222-00023	RETROFIT	GU10	230	305 x 90 x 125	☐ white	106,80
222-00024	RETROFIT	GU10	230	305 x 90 x 125	■ black	106,80



MISSOR III SD GU10

ART. NR./CODE	LM/BULB	FASSUNG/SOCKET	V AC	L x B x H/L x W x H	FARBE/COLOUR	CHF
222-00025	RETROFIT	GU10	230	480 x 90 x 125	☐ white	166,80
222-00026	RETROFIT	GU10	230	480 x 90 x 125	■ black	166,80



MISSOR DEKORRING/DECORATION RING

ART. NR./CODE	INFORMATION	FARBE/COLOUR	CHF
276-7000	Ring aus Kunststoff, gold, weiß oder schwarz werkzeuglos wechselbar (separat ordern)	■ gold	8,28
276-7001	Syntetic decoration ring, gold, white or black, changeable without tools (order separately)	☐ white	8,28
222-A00021		■ black	8,28

LEUCHTMITTEL/LIGHT SOURCE

Weitere Leuchtmittel S./additional light sources P. 290

ART. NR./CODE	INFORMATION	CHF
30-752517	Core Pro LED Spot, GU10,5W, 827 Kelvin	7,80







NEW

QANA ROUND SD

ART. NR./CODE	LM/BULB	FASSUNG/SOCKET	V AC	Ø x H	FARBE/COLOUR	CHF
222-00009	RETROFIT	GU10	230	94 x 94	☐ white	82,80
222-00010	RETROFIT	GU10	230	94 x 94	■ black	82,80



NEW

QANA BOX 1 SD

ART. NR./CODE	LM/BULB	FASSUNG/SOCKET	V AC	L x B x H/L x W x H	FARBE/COLOUR	CHF
222-00011	RETROFIT	GU10	230	94 x 94 x 94	☐ white	88,80
222-00012	RETROFIT	GU10	230	94 x 94 x 94	■ black	88,80



NEW

QANA BOX 2 SD

ART. NR./CODE	LM/BULB	FASSUNG/SOCKET	V AC	L x B x H/L x W x H	FARBE/COLOUR	CHF
222-00013	RETROFIT	GU10	230	187 x 94 x 94	☐ white	160,80
222-00014	RETROFIT	GU10	230	187 x 94 x 94	■ black	160,80

**LEUCHTMITTEL/LIGHT SOURCE**

Weitere Leuchtmittel S./additional light sources P. 290

ART. NR./CODE	INFORMATION	CHF
30-752517	Core Pro LED Spot, GU10,5W, 827 Kelvin	7,80

MUSO







Deckenaufbauleuchte, Polycarbonat, 3 Größen

BWM: Mit DIP-Switch zur Einstellung von Stand-By Zeit/Tageslichtsensor/Leuchtdauer und Bewegungsradius

Surface-mounted ceiling light, polycarbonate, 3 sizes **MD:** With dip switch for setting stand-by time/daylight sensor/light duration and movement radius

MUSO ROUND SD



ART. NR./CODE	LEISTUNG/POWER	LUMEN	CRI>	KELVIN	Ø x H/Ø x H	FARBE/COLOUR	REFL.	CHF
501-r2819150	SYS 18W	1750	80	3000	280 x 48	white	115°	82,80
501-r3319150	SYS 24W	2270	80	3000	330 x 48	white	115°	118,80
501-r4019150	SYS 36W	3200	80	3000	400 x 48	white	115°	154,80

NEW

MUSO ROUND SD SENSOR





ART. NR./CODE	LEISTUNG/POWER	LUMEN	CRI>	KELVIN	Ø x H/Ø x H	FARBE/COLOUR	REFL.	CHF
222-00056	SYS 18W	1820	80	3000/4000	280 x 53	white	115°	118,80
222-00058	SYS 24W	2880	80	3000/4000	330 x 53	white	115°	142,80

NEW

MUSO ROUND SD DALI



ART. NR./CODE	LEISTUNG/POWER	LUMEN	CRI>	KELVIN	Ø x H/Ø x H	FARBE/COLOUR	REFL.	CHF
222-00055	SYS 18W	1980	80	3000/4000	280 x 58	white	115°	142,80
222-00057	SYS 24W	2640	80	3000/4000	330 x 58	white	115°	166,80

IP54 IK08  



Bei allen Größen erfolgt die Montage der Leuchte an der Grundplatte mittels Montageclip. Eine Aussparung für seitliche Kabeleinführung ist vorhanden.

For all sizes, the luminaire is mounted to the bracket through a mounting clip. A recess for lateral cable entry is existing.



BWM: Der Bewegungsmelder ist seitlich hinter einer Abdeckung einstellbar.

The motion detector is adjustable on the side behind a cover.





Deckenaufbauleuchte, Polycarbonat, 3 Größen

BWM: Mit DIP-Switch zur Einstellung von Stand-By Zeit/Tageslichtsensor/Leuchtdauer und Bewegungsradius

Surface-mounted ceiling light, polycarbonate, 3 sizes

MD: With dip switch for setting stand-by time/daylight sensor/light sensor/light duration and movement radius

MUSO SQUARE SD



ART. NR./CODE	LEISTUNG/POWER	LUMEN	CRI>	KELVIN	L x B x H/L x W x H	FARBE/COLOUR	CHF
501-q2819150	SYS 18W	1750	80	3000	280 x 280 x 48	white	82,80
501-q3319150	SYS 24W	2270	80	3000	330 x 330 x 48	white	118,80
501-q4019150	SYS 36W	3200	80	3000	400 x 400 x 48	white	154,80

NEW

MUSO SQUARE SD SENSOR



ART. NR./CODE	BMW/MD	LEISTUNG/POWER	LUMEN	CRI>	KELVIN	L x B x H/L x W x H	FARBE/COLOUR	CHF
222-00062	X	SYS 18W	1820	80	3000/4000	280 x 280 x 53	white	118,80
222-00064	X	SYS 24W	2485	80	3000/4000	330 x 330 x 53	white	142,80



Bei den Größen 280 & 330 erfolgt die Montage der Leuchte an der Grundplatte mittels Montageclip. Bei der Größe 400 ist die Montage verschraubt. Eine Aussparung für seitliche Kabeleinführung ist vorhanden.

For all sizes 280 & 330, the luminaire is mounted to the bracket through a mounting clip. For size 400 the luminaire is mounted on the bracket through screws. A recess for lateral cable entry is existing.



BWM: Der Bewegungsmelder ist seitlich hinter einer Abdeckung einstellbar.

The motion detector is adjustable on the side behind a cover.







Deckenaufbauleuchte, Polycarbonat Abdeckung Ausstrahlwinkel 120°, Durchgangsverdrahtung möglich, IP54, auch als Variante DALI dimmbar verfügbar

Surface-mounted ceiling light, polycarbonate cover Beam angle 120°, through-wiring possible, IP54, also available as a DALI dimmable

NEW

MUSO LINEAR SD



ART. NR./CODE	LEISTUNG/POWER	LUMEN	CRI>	KELVIN	L x B x H/L x W x H	FARBE/COLOUR	REFL.	CHF
222-00066	SYS 18W	2450/2560	80	3000/4000	600 x 140 x 52	white	120°	142,80
222-00067	SYS 36W	4980/5260	80	3000/4000	1200 x 140 x 52	white	120°	226,80



NEW

MUSO 120 LINEAR CCT DALI



ART. NR./CODE	LEISTUNG/POWER	LUMEN	CRI>	KELVIN	L x B x H/L x W x H	FARBE/COLOUR	REFL.	CHF
222-00059	SYS 36W	4980/5260	80	3000/4000	1200 x 140 x 59	white	115°	286,80





Aufbauleuchte, Sockel aus Stahlblech, pulverbeschichtet weiß, mundgeblasenes Dreischichtglas TRIPLEX opal matt, Schirmbefestigung mittels Klappfedern

Surface-mounted luminaire, base made of sheet steel, powder-coated white, hand-blown TRIPLEX opal matt three-layer glass, shade fastening with hinged springs

ALKOR 2 E27

ART. NR./CODE	LM/BULB	FASSUNG/SOCKET	V AC	Ø x H	SOCKEL/SOCKET	FARBE/COLOUR	CHF
789-52162	RETROFIT	E27	230	104 x 156	Ø 120	□ white	116,88



Aufbauleuchte, Sockel aus Stahlblech, pulverbeschichtet weiß, mundgeblasenes Dreischichtglas TRIPLEX opal matt, Schirmbefestigung mittels Klappfedern

Surface-mounted luminaire, base made of sheet steel, powder-coated white, hand-blown TRIPLEX opal matt three-layer glass, shade fastening with hinged springs

APUS E27

ART. NR./CODE	LM/BULB	FASSUNG/SOCKET	V AC	L x B x H/L x W x H	SOCKEL/SOCKET	FARBE/COLOUR	CHF
789-52160	RETROFIT	E27	230	140 x 140 x 156	Ø 120	□ white	135,96
789-52161	RETROFIT	E27	230	184 x 184 x 200	Ø 160	□ white	177,96
789-71277	RETROFIT	E27	230	230 x 230 x 250	Ø 200	□ white	364,68



AUFBAUGEHÄUSE/SURFACE HOUSING



ART. NR./CODE	INFO	L x B x H/L x W x H	FARBE/COLOUR	CHF
789-33510	dekorative Abdeckung aus Metall - nur passend für Apus 184 x 184mm/ Decorative metal cover - only suitable for Apus 184 x 184mm	235 x 184 x 184	■ black	49,56



Wand-/ Deckenleuchte, Trägerplatte Stahlblech, weiß lackiert, Abdeckung, mundgeblasenes Dreischichtglas Triplex-Opal mit mattierter Oberfläche, Bajonettverschluss

Wall/ceiling light, support plate sheet steel, painted white, cover, hand-blown three-layer glass triplex opal with frosted surface, bayonet catch

ELSA E27

ART. NR./CODE	LM/BULB	FASSUNG/SOCKET	V AC	Ø x H	SOCKEL/SOCKET	FARBE/COLOUR	CHF
789-44705	2x RETROFIT	E27	230	250 x 84	Ø 205	□ white	111,84
789-44741	2x RETROFIT	E27	230	300 x 86	Ø 250	□ white	134,76
789-44900	2x RETROFIT	E27	230	420 x 90	Ø 345	□ white	306,24



LEUCHTMITTEL/LIGHT SOURCE

Weitere Leuchtmittel S./additional light sources P. 290

ART. NR./CODE	INFORMATION	CHF
30-449718	A60/MASTER VLE LED Bulb clear, E27,6W, 922-927 Kelvin	15,24





Wand-/ Deckenleuchte, Trägerplatte Stahlblech, weiß lackiert, opale Polycarbonatabdeckung, Schirmbefestigung mittels Klappfedern,

BWM: mit Bewegungsmelder 1 - 5m
Versionen mit Glasabdeckung auf Anfrage

Wall/ceiling light, support plate sheet steel, painted white, opal polycarbonate cover, shade fastened using hinged springs,

MD: with motion detector 1 - 5m
Versions with glass cover on request

DELIA E27

ART. NR./CODE	LM/BULB	BWM/MD	FASSUNG/SOCKET	V AC	Ø x H	SOCKEL/SOCKET	FARBE/COLOUR	CHF
789-52112	RETROFIT	---	E27	230	220 x 70	Ø 200	<input type="checkbox"/> white	86,40
789-56075	RETROFIT	---	E27	230	300 x 75	Ø 275	<input type="checkbox"/> white	96,60
789-56079	RETROFIT	X	E27	230	300 x 75	Ø 275	<input type="checkbox"/> white	157,56
789-52560	2x RETROFIT	---	E27	230	360 x 71	Ø 342	<input type="checkbox"/> white	127,08
789-56110	2x RETROFIT	---	E27	230	400 x 80	Ø 375	<input type="checkbox"/> white	138,48
789-56116	2x RETROFIT	X	E27	230	400 x 80	Ø 375	<input type="checkbox"/> white	191,88
789-56130	3x RETROFIT	---	E27	230	500 x 85	Ø 465	<input type="checkbox"/> white	176,64
789-56137	3x RETROFIT	X	E27	230	500 x 85	Ø 465	<input type="checkbox"/> white	236,40



IP44

LEUCHTMITTEL/LIGHT SOURCE

Weitere Leuchtmittel S./additional light sources P. 290

ART. NR./CODE	INFORMATION	CHF
30-449718	A60/MASTER VLE LED Bulb clear, E27,6W, 922-927 Kelvin	15,24



Wand-/ Deckenleuchte, Trägerplatte Stahlblech, weiß lackiert, opale Polycarbonat-Abdeckung oder PMMA-Abdeckung, Schirmbefestigung mittels Klappfedern, inkl. Konverter

BWM: mit Bewegungsmelder 1 - 5m

Wall/ceiling light, support plate sheet steel, painted white, opal polycarbonate cover or PMMA cover, shade cover, shade fastening by means of hinged springs, incl. converter

MD: with motion detector 1 - 5m

DELIA

ART. NR./CODE	LEISTUNG/POWER	BWM/MD	LUMEN	CRI>	KELVIN	Ø x H	SOCKEL/SOCKET	FARBE/COLOUR	CHF
789-56275	SYS 5W	---	460	80	<input type="checkbox"/> 3000	140 x 65	120	<input type="checkbox"/> white	148,68
789-56775	SYS 5W	---	480	80	<input type="checkbox"/> 4000	140 x 65	120	<input type="checkbox"/> white	148,68
789-56282	SYS 11W	---	950	80	<input type="checkbox"/> 3000	220 x 70	200	<input type="checkbox"/> white	152,52
789-56782	SYS 11W	---	1000	80	<input type="checkbox"/> 4000	220 x 70	200	<input type="checkbox"/> white	152,52
789-56290	SYS 15W	---	1480	80	<input type="checkbox"/> 3000	300 x 75	275	<input type="checkbox"/> white	196,92
789-56291	SYS 15W	X	1480	80	<input type="checkbox"/> 3000	300 x 75	275	<input type="checkbox"/> white	251,64
789-56790	SYS 15W	---	1560	80	<input type="checkbox"/> 4000	300 x 75	275	<input type="checkbox"/> white	196,92
789-53316	SYS 20W	---	1920	80	<input type="checkbox"/> 3000	300 x 75	275	<input type="checkbox"/> white	207,12
789-53816	SYS 20W	---	2000	80	<input type="checkbox"/> 4000	300 x 75	275	<input type="checkbox"/> white	207,12
789-67200	SYS 19W	---	1750	80	<input type="checkbox"/> 3000	360 x 71	342	<input type="checkbox"/> white	270,72
789-67700	SYS 19W	---	1830	80	<input type="checkbox"/> 4000	360 x 71	342	<input type="checkbox"/> white	270,72
789-67206	SYS 27W	---	2350	80	<input type="checkbox"/> 3000	360 x 71	342	<input type="checkbox"/> white	278,28
789-56300	SYS 29W	---	2580	80	<input type="checkbox"/> 3000	400 x 80	375	<input type="checkbox"/> white	288,48
789-56301	SYS 29W	X	2580	80	<input type="checkbox"/> 3000	400 x 80	375	<input type="checkbox"/> white	325,32
789-53337	SYS 33W	---	3400	80	<input type="checkbox"/> 3000	400 x 80	375	<input type="checkbox"/> white	288,48
789-53837	SYS 36W	---	3550	80	<input type="checkbox"/> 4000	400 x 80	375	<input type="checkbox"/> white	288,48



IP54







Wand-/ Deckenleuchte, Trägerplatte Stahlblech, weiß lackiert, mundgeblasenes Dreischichtglas TRIPLEX opal matt, Halterung mittels Bajonettverschluss

Wall/ceiling light, support plate sheet steel, painted white, hand-blown TRIPLEX opal three-layer glass matt, bracket with bayonet catch



AURA E27

ART. NR./CODE	LM/BULB	FASSUNG/SOCKET	V AC	Ø x H	SOCKEL/SOCKET	FARBE/COLOUR	CHF
789-42702	RETROFIT	E27	230	200 x 105	Ø 170	<input type="checkbox"/> white	97,80
789-42703	RETROFIT	E27	230	250 x 110	Ø 205	<input type="checkbox"/> white	109,32
789-42709	2x RETROFIT	E27	230	300 x 115	Ø 250	<input type="checkbox"/> white	129,60
789-42742	2x RETROFIT	E27	230	360 x 125	Ø 290	<input type="checkbox"/> white	180,48
789-42775	2x RETROFIT	E27	230	420 x 125	Ø 345	<input type="checkbox"/> white	259,20



IP44



Wand-/ Deckenleuchte, Trägerplatte Stahlblech, weiß lackiert, Polycarbonat Abdeckung weiß satiniert, Halterung mittels Bajonettverschluss

Wall/ceiling light, support plate Sheet steel, painted white, polycarbonate cover satined white, bracket with bayonet catch



TITAN E27

ART. NR./CODE	LM/BULB	FASSUNG/SOCKET	V AC	Ø x H	SOCKEL/SOCKET	FARBE/COLOUR	CHF
789-56050	RETROFIT	E27	230	220 x 100	Ø 170	<input type="checkbox"/> white	86,40
789-56000	RETROFIT	E27	230	300 x 105	Ø 275	<input type="checkbox"/> white	97,80
789-56012	2x RETROFIT	E27	230	400 x 115	Ø 375	<input type="checkbox"/> white	138,48
789-56024	3x RETROFIT	E27	230	500 x 130	Ø 465	<input type="checkbox"/> white	176,64
789-56056	4x RETROFIT	E27	230	650 x 150	Ø 625	<input type="checkbox"/> white	318,96
789-56061	6x RETROFIT	E27	230	900 x 200	Ø 875	<input type="checkbox"/> white	537,12



IP44

LEUCHTMITTEL/LIGHT SOURCE

Weitere Leuchtmittel S./additional light sources P. 290

ART. NR./CODE	INFORMATION	CHF
30-449718	A60/MASTER VLE LED Bulb clear, E27,6W, 922-927 Kelvin	15,24





Wand-/ Deckenleuchte, Trägerplatte Stahlblech weiß, mundgeblasenes Dreischichtglas TRIPLEX opal matt, Schirmbefestigung mittels Klappfedern

wall/ceiling light, white sheet steel support plate, hand-blown TRIPLEX opal matt three-layer glass, shade fastening by means of hinged springs



LINA E27

ART. NR./CODE	LM/BULB	FASSUNG/SOCKET	V AC	L x B x H/L x W x H	SOCKEL/SOCKET	FARBE/COLOUR	CHF
789-41252	RETROFIT	E27	230	200 x 200 x 105	Ø 175	<input type="checkbox"/> white	125,76
789-41262	RETROFIT	E27	230	200 x 200 x 105	Ø 175	<input type="checkbox"/> white	125,76
789-41270	2x RETROFIT	E27	230	260 x 260 x 110	Ø 230	<input type="checkbox"/> white	160,08
789-41307	2x RETROFIT	E27	230	320 x 320 x 115	Ø 275	<input type="checkbox"/> white	294,84
789-42310	2x RETROFIT	E27	230	380 x 380 x 120	Ø 325	<input type="checkbox"/> white	325,32



Wand-/ Deckenleuchte, Trägerplatte Stahlblech, weiß lackiert, opale Polycarbonatabdeckung, Schirmbefestigung mittels Klappfedern **BWM**: mit Bewegungsmelder 1 - 5m

Wall/ceiling light, support plate Sheet steel, painted white, opal polycarbonate cover, shade fastening by means of hinged springs **MD**: with motion detector 1 - 5m



TILIA E27

ART. NR./CODE	LM/BULB	BWM/MD	FASSUNG/SOCKET	V AC	L x B x H/L x W x H	SOCKEL L x B/SOCKET L x W	FARBE/COLOUR	CHF
789-52120	RETROFIT	---	E27	230	220 x 220 x 70	200 x 200	<input type="checkbox"/> white	92,76
789-56155	2x RETROFIT	---	E27	230	300 x 300 x 70	270 x 270	<input type="checkbox"/> white	120,12
789-56159	2x RETROFIT	X	E27	230	300 x 300 x 70	270 x 270	<input type="checkbox"/> white	196,92
789-52575	2x RETROFIT	---	E27	230	360 x 360 x 70	337 x 337	<input type="checkbox"/> white	158,88
789-56171	3x RETROFIT	---	E27	230	400 x 400 x 70	400 x 400	<input type="checkbox"/> white	168,96
789-52121	4x RETROFIT	---	E27	230	550 x 550 x 70	550 x 550	<input type="checkbox"/> white	287,16



LEUCHTMITTEL/LIGHT SOURCE

Weitere Leuchtmittel S./additional light sources P. 290

ART. NR./CODE	INFORMATION	CHF
30-449718	A60/MASTER VLE LED Bulb clear, E27,6W, 922-927 Kelvin	15,24



Kugelleuchte, opale PMMA-Abdeckung matt satiniert, Kabelaufhängung, auf Anfrage Abhängung mit Stahlseil und Kabel bzw. starrem Pendel aus Aluminium erhältlich

Spherical luminaire, opal PMMA cover, matt satin finish, cable suspension, suspension with steel cable and aluminium cable or rigid pendant available on request.



ISIS E27



ART. NR./CODE	LM/BULB	FASSUNG/SOCKET	V AC	Ø	ABHÄNG./SUSP.	FARBE/COLOUR	FARBE ABDECKUNG/COLOUR COVER	CHF
789-63805	RETROFIT	E27	230	300	2000	<input type="checkbox"/> white	<input type="checkbox"/> white	256,68
789-63806	RETROFIT	E27	230	300	2000	<input type="checkbox"/> white	<input checked="" type="checkbox"/> black	256,68
789-63810	RETROFIT	E27	230	400	2000	<input type="checkbox"/> white	<input type="checkbox"/> white	339,36
789-63811	RETROFIT	E27	230	400	2000	<input type="checkbox"/> white	<input checked="" type="checkbox"/> black	339,36
789-63815	RETROFIT	E27	230	500	2000	<input type="checkbox"/> white	<input type="checkbox"/> white	419,40
789-63816	RETROFIT	E27	230	500	2000	<input type="checkbox"/> white	<input checked="" type="checkbox"/> black	419,40



IP40



LEUCHTMITTEL/LIGHT SOURCE

Weitere Leuchtmittel S./additional light sources P. 290

ART. NR./CODE	INFORMATION	CHF
30-380035	A60/CorePro LED Bulb clear, E27,7W, 827 Kelvin	5,88



WANDLEUCHTEN WALLLAMPS





TECNICO INDOOR



LED Aufbauleuchte aus Aluminium, matt Feinstruktur pulverbeschichtet, direkt/indirekt breitstrahlend, inkl. Konverter

Wall luminaire, aluminium, powder-coated, direct/indirect beam, incl. driver

FORO SHORT W



ART. NR./CODE	LEISTUNG/POWER	LUMEN	CRI>	KELVIN	L x B x H/L x W x H	FARBE/COLOUR	CHF
341-40003440	SYS 4W	260	90	2700	70 x 60 x 75	silver	94,80
341-40003550	SYS 4W	260	90	2700	70 x 60 x 75	white	94,80
341-40009440	SYS 4W	260	90	3000	70 x 60 x 75	silver	94,80
341-40009550	SYS 4W	260	90	3000	70 x 60 x 75	white	94,80



LED Aufbauleuchte aus Aluminium, matt Feinstruktur pulverbeschichtet, direkt/indirekt breitstrahlend, inkl. Konverter

Wall luminaire, aluminium, powder-coated, direct/indirect beam, incl. driver

FORO LONG W



ART. NR./CODE	LEISTUNG/POWER	LUMEN	CRI>	KELVIN	L x B x H/L x W x H	FARBE/COLOUR	CHF
341-40013440	SYS 11W	935	90	2700	300 x 70 x 100	silver	238,80
341-40013550	SYS 11W	935	90	2700	300 x 70 x 100	white	238,80
341-40019440	SYS 11W	950	90	3000	300 x 70 x 100	silver	293,76
341-40019550	SYS 11W	950	90	3000	300 x 70 x 100	white	238,80

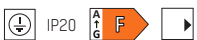





Wandleuchte, Aluminium lackiert oder pulverbeschichtet, direkt/indirekt breitstrahlend, inkl. Konverter

Wall luminaire, aluminium, brushed or powder-coated, direct/indirect beam, incl. driver

NOVEL



ART. NR./CODE	LEISTUNG/POWER	LUMEN	CRI>	KELVIN	L x B x H/L x W x H	FARBE/COLOUR	CHF
472-3927050	SYS 8W	360	90	2700	100 x 100 x 100	white	226,80
472-3927060	SYS 8W	130	90	2700	100 x 100 x 100	black	226,80
472-39270630	SYS 8W	190	90	2700	100 x 100 x 100	black/gold	274,80
472-39270140	SYS 8W	260	90	2700	100 x 100 x 100	alu brushed	226,80
472-3929050	SYS 8W	400	90	3000	100 x 100 x 100	white	226,80
472-3929060	SYS 8W	145	90	3000	100 x 100 x 100	black	226,80
472-39290630	SYS 8W	210	90	3000	100 x 100 x 100	black/gold	274,80
472-39290140	SYS 8W	290	90	3000	100 x 100 x 100	alu brushed	226,80

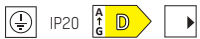

Wandleuchte, Aluminium, pulverbeschichtet oder lackiert, direkt/indirekt breitstrahlend, inkl. Konverter

Wall luminaire, aluminium, brushed or powder-coated, direct/indirect beam, incl. driver

ALICA



ART. NR./CODE	LEISTUNG/POWER	LUMEN	CRI>	KELVIN	L x B x H/L x W x H	FARBE/COLOUR	CHF
472-0000790002705	SYS 7W	400	90	2700	200 x 100 x 70	white	238,80
472-0000790002706	SYS 7W	215	90	2700	200 x 100 x 70	black	238,80
472-0000790002763	SYS 7W	305	90	2700	200 x 100 x 70	black/gold	286,80
472-0000790002714	SYS 7W	320	90	2700	200 x 100 x 70	alu brushed	238,80
472-0000790003005	SYS 7W	420	90	3000	200 x 100 x 70	white	238,80
472-0000790003006	SYS 7W	220	90	3000	200 x 100 x 70	black	238,80
472-0000790003063	SYS 7W	320	90	3000	200 x 100 x 70	black/gold	286,80
472-0000790003014	SYS 7W	330	90	3000	200 x 100 x 70	alu brushed	238,80





128

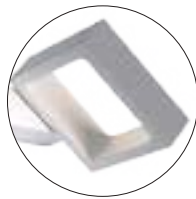

Wandleuchte, Aluminiumdruckguss, Feinstruktur matt pulverbeschichtet, direkt/indirekt strahlend, Leuchtenkopf 345° drehbar, inkl. Konverter

Wall luminaire, die-cast aluminium, powder-coated, direct/indirect beam, head 345° swiveling, incl. driver

BO SINGLE



ART. NR./CODE	LEISTUNG/POWER	LUMEN	CRI>	KELVIN	L x B x H/L x W x H	FARBE/COLOUR	CHF
472-0827050	SYS 6W	285	90	2700	135 x 30 x 135	white	214,80
472-0827060	SYS 6W	175	90	2700	135 x 30 x 135	black	214,80

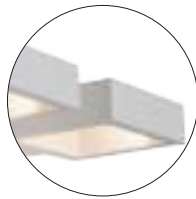

Wandleuchte, 2 flammig, Aluminiumdruckguss, Feinstruktur matt pulverbeschichtet, direkt/indirekt strahlend, Leuchtenköpfe 345° drehbar, inkl. Konverter

Wall luminaire, 2-spots, die-cast aluminium, powder-coated, direct/indirect beam, head 345° swiveling, incl. driver

BO DOUBLE



ART. NR./CODE	LEISTUNG/POWER	LUMEN	CRI>	KELVIN	L x B x T/L x W x D	FARBE/COLOUR	CHF
472-0927050	SYS 2x 6W	565	90	2700	240 x 30 x 135	white	322,80
472-0927060	SYS 2x 6W	330	90	2700	240 x 30 x 135	black	322,80



Wandleuchte, Aluminium lackiert oder pulverbeschichtet, direkt/indirekt strahlend

Wall luminaire, aluminium, brushed or powder-coated, direct/indirect beam

TAKE G9



ART. NR./CODE	LM/BULB	FASSUNG/SOCKET	V AC	L x B x T/L x W x D	FARBE/COLOUR	CHF
472-291009w	RETROFIT	G9	230	100 x 100 x 100	white	82,80
472-291009b	RETROFIT	G9	230	100 x 100 x 100	black	82,80
472-291009a	RETROFIT	G9	230	100 x 100 x 100	alu brushed	82,80



LEUCHTMITTEL/LIGHT SOURCE

Weitere Leuchtmittel S./additional light sources P. 290

ART. NR./CODE	INFORMATION	CHF
30-657802	Core Pro LED Capsule, G9,5W, 827 Kelvin, nicht dimmbar/not dimmable	31,68

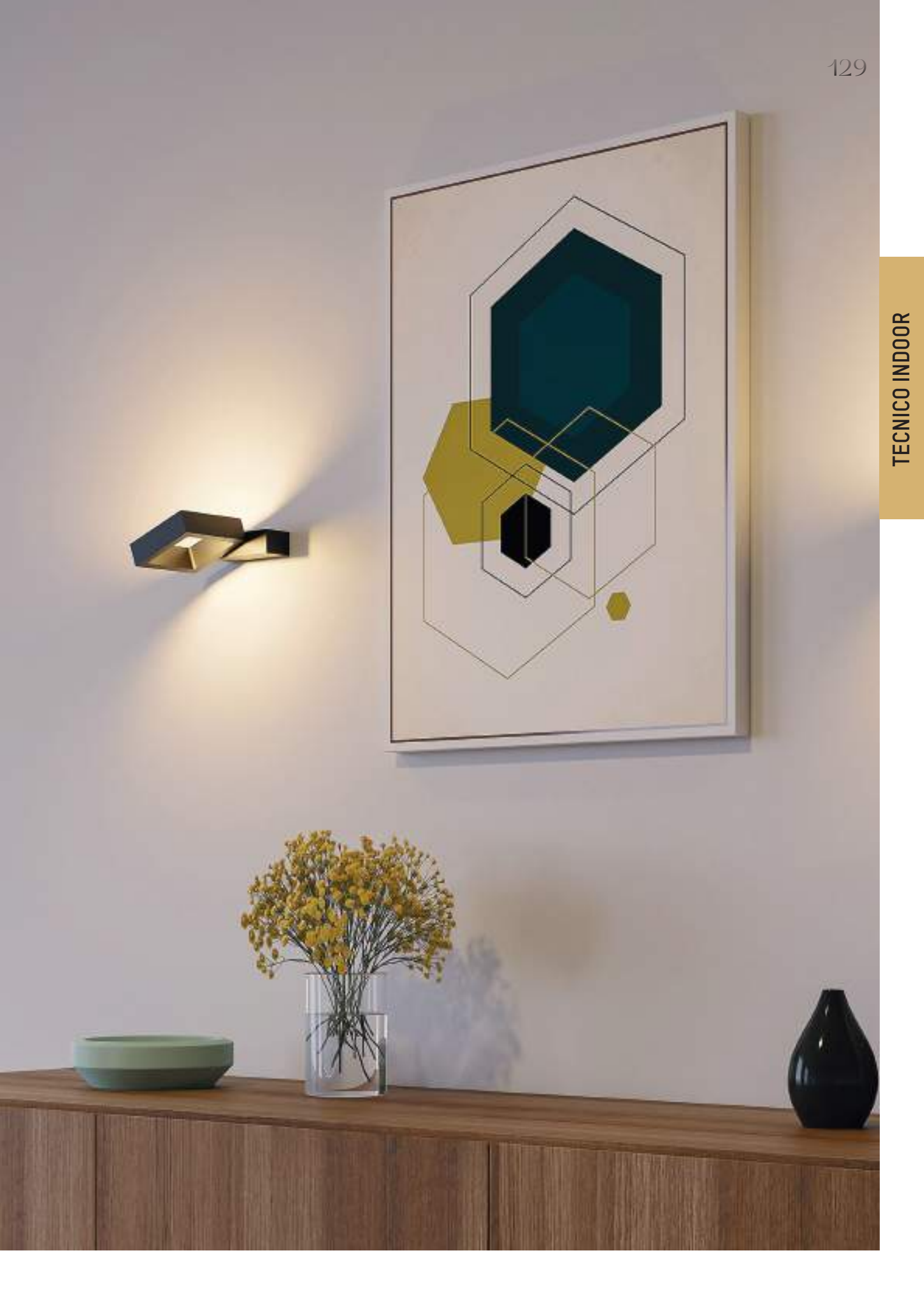



Wandaufbauleuchte, aus Aluminium, Lichtaustritt direkt, DIP-Switch

Surface-mounted wall light, made of aluminium, light emission direct, dipswitch

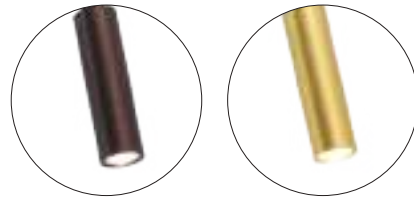

NEW

AROK W



ART. NR./CODE	LEISTUNG/POWER	LUMEN	CRI>	KELVIN	Ø x L x B x H/Ø x L x W x H	FARBE/COLOUR	CHF
222-00093	SYS 7W	255/280	90	2700/3000	26 x 35 x 30 x 180	black/black	202,80
222-00094	SYS 7W	255/280	90	2700/3000	26 x 35 x 30 x 180	black/gold	202,80
222-00095	SYS 7W	255/280	90	2700/3000	26 x 35 x 30 x 180	black/coffee	202,80





Wandaufbauleuchte, aus Aluminium, schwenkbar 90°, drehbar 350°, direkt/indirekt strahlend

Surface-mounted wall light, made of aluminium, swivelling 90°, rotatable 350°, direct/indirect distribution



CLARUS



ART. NR./CODE	LEISTUNG/POWER	LUMEN	CRI>	KELVIN	Ø x T/Ø x D	FARBE/COLOUR	REFL.	CHF
276-0151090402705tr	SYS 11W	400	90	2700	120 x 82	white	40°	322,80
276-0151090402706tr	SYS 11W	365	90	2700	120 x 82	black	40°	322,80
276-0151090402763tr	SYS 11W	365	90	2700	120 x 82	black/gold	40°	322,80





Spiegelleuchte mit zylindrischer Abdeckung, Diffusor aus satiniertem Polycarbonat, Trägerprofil und Enddeckel verchromt, Einspeisung mittig an der Leuchten-Rückseite.

Mirror light with cylindrical cover, diffuser made of satinised polycarbonate, support profile and end cap chrome-plated, power feed centred on the back of the light.

SERIE 44 SHORT SD



ART. NR./CODE	LEISTUNG/POWER	LUMEN	CRI>	KELVIN	L x B x H/L x W x H	FARBE/COLOUR	REFL.	CHF
120-40079100	SYS 20W	1220	80	2700	528 x 93 x 55	white/chrome	---	178,80

SERIE 44 LONG SD



ART. NR./CODE	LEISTUNG/POWER	LUMEN	CRI>	KELVIN	L x B x H/L x W x H	FARBE/COLOUR	REFL.	CHF
120-40089100	SYS 36W	1740	80	2700	828 x 93 x 55	white/chrome	---	238,80



Spiegelleuchte, opale Polycarbonatabdeckung, Sockel aus Aluminium, Schirmbefestigung mittels Klappfedern, Einspeisung an der Seite bzw. mittig an der Leuchten-Rückseite möglich

Mirror light, opal polycarbonate cover, aluminium base, shade fastening by means of hinged springs, feed-in possible at the side or centre at the rear of the light

MATAR



ART. NR./CODE	LEISTUNG/POWER	LUMEN	CRI>	KELVIN	L x B x H/L x W x H	FARBE ABDECKUNG/COLOUR COVER	FARBE SOCKEL/COLOUR SOCKET	CHF
789-71032	SYS 13W	1400	80	3000	600 x 60 x 46	white	white	209,64
789-71532	SYS 13W	1470	80	4000	600 x 60 x 46	white	white	209,64
789-71040	SYS 19W	2090	80	3000	900 x 60 x 46	white	white	274,44
789-71540	SYS 19W	2200	80	4000	900 x 60 x 46	white	white	274,44
789-71036	SYS 13W	1400	80	3000	600 x 60 x 46	white	black	209,64
789-71536	SYS 13W	1470	80	4000	600 x 60 x 46	white	black	200,76
789-71044	SYS 19W	2090	80	3000	900 x 60 x 46	white	black	274,44
789-71544	SYS 19W	2200	80	4000	900 x 60 x 46	white	black	274,44





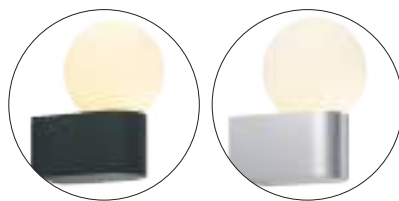

Badezimmerleuchte mit IP44 Schutzklasse, Echtglas in zwei Ausführungen, G9 Leuchtmittel - flexibel in Lichtfarbe und Intensität

Bathroom light with IP44 protection class, real glass in two versions, G9 light source - flexible in light colour and intensity

NEW

LANU ROUND W



ART. NR./CODE	LM/BULB	FASSUNG/SOCKET	V AC	B x H/L x W x H	FARBE/COLOUR	CHF
222-00113	RETROFIT	G9	230	110 x 167	white	166,80
222-00114	RETROFIT	G9	230	110 x 167	black	166,80
222-00115	RETROFIT	G9	230	110 x 167	chrome	178,80



LEUCHTMITTEL/LIGHT SOURCE

Weitere Leuchtmittel S./additional light sources P. 290

ART. NR./CODE	INFORMATION	CHF
30-657802	Core Pro LED Capsule, G9,5W, 827 Kelvin	31,68



NEW

LANU FLAT W



ART. NR./CODE	LM/BULB	FASSUNG/SOCKET	V AC	L x B x H/L x W x H	FARBE/COLOUR	CHF
222-00116	RETROFIT	G9	230	115 x 100 x 168	white	166,80
222-00117	RETROFIT	G9	230	115 x 100 x 168	black	166,80
222-00118	RETROFIT	G9	230	115 x 100 x 168	chrome	178,80



LEUCHTMITTEL/LIGHT SOURCE

Weitere Leuchtmittel S./additional light sources P. 290

ART. NR./CODE	INFORMATION	CHF
30-657802	Core Pro LED Capsule, G9,5W, 827 Kelvin	31,68

TECNICO INDOOR

SCHUTZZONEN PROTECTION ZONES

- ZONE 2 | IP44
- ZONE 3 | IP65
- ZONE 4 | IP67

IP44
geschützt gegen Spritzwasser/
Protected against splash water

IP65
geschützt gegen Strahlwasser/
Protected against water jets

IP67
geschützt gegen zeitweises Eintauchen/
Protected against temporary immersion





Wandleuchte aus Aluminium, perlchrom galvanisiert oder schwarz, runder Leuchtenkopf, hochwertige Glaslinse 60° klar, flexiblem Arm, Ein/Aus-Schalter an der Leuchte, inkl. Konverter, Kopf: Ø 34, L 40
Baldachin: Ø 63, H 44

LED aluminium reading lamp, pearl chrome, chrome or black surface, high quality clear glass 60° lens, surface with switch, incl. driver
Head: Ø 34, L 40
Canopy: Ø 63, H 44

MOTUS LONG W



ART. NR./CODE	LEISTUNG/POWER	LUMEN	CRI>	KELVIN	L	FARBE/COLOUR	REFL.	CHF
56-53312ng2	SYS 2W	160	90	3000	max. 380	perlchrome	60°	382,80
56-53313ng2	SYS 2W	160	90	3000	max. 380	black	60°	382,80



Flexible LED Leseleuchte Aluminium, Kopf & Wandmontage Flexarm schwarz, Lichtkegel stufenlos am Kopf fokussierbar 10° - 60°, Ein/Aus Schalter schwarz an der Leuchte, inkl. Konverter, Kopf: DM 20, L60, Baldachin: DM 63, H37

Flexible LED aluminium reading lamp, black arm, head with infinitely adjustable light cone 10° - 60°, incl. on/off switch, canopy: Ø 63, D 37mm, incl. driver

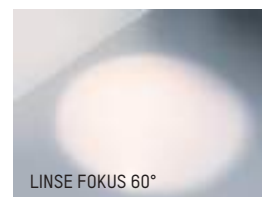

ZHOOM W



ART. NR./CODE	LEISTUNG/POWER	LUMEN	CRI>	KELVIN	L	FARBE/COLOUR	CHF
56-185034ng1	SYS 2W	150	90	2700	max. 300	white	495,60
56-185036ng1	SYS 2W	150	90	2700	max. 300	black	495,60
56-185035ng1	SYS 2W	150	90	2700	max. 300	alu brushed	495,60
56-185033ng1	SYS 2W	150	90	3000	max. 300	white	495,60
56-185032ng1	SYS 2W	150	90	3000	max. 300	black	495,60
56-185030ng1	SYS 2W	150	90	3000	max. 300	alu brushed	495,60





WALL





NEW

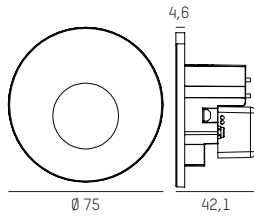

Wand-Einbaubleuchte aus Aluminium, Helligkeit und Lichtfarbe vor Einbau einstellbar, Durchgangsverdrahtung

Recessed wall luminaire made of aluminium, brightness and light colour pre adjustable, through-wiring

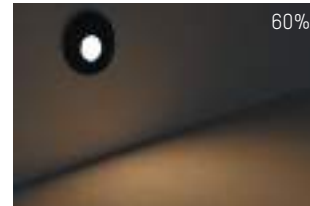
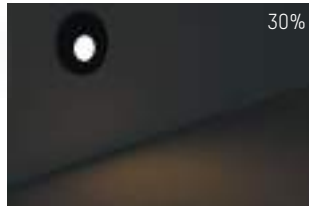

Einstellbare Helligkeit 30/60/100%/Adjustable brightness 30/60/100%



WALL 68R

ART. NR./CODE	LEISTUNG/POWER	LUMEN	CRI>	KELVIN	Ø x ET/Ø x ID	Ⓢ	FARBE/COLOUR	CHF
222-00001	SYS 4W	90	90	2700/3000/4000	75 x 42	68	white	106,80
222-00002	SYS 4W	90	90	2700/3000/4000	75 x 42	68	black	106,80

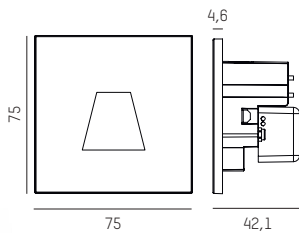

Wand-Einbaubleuchte aus Aluminium, Helligkeit und Lichtfarbe vor Einbau einstellbar, Durchgangsverdrahtung

Recessed wall luminaire made of aluminium, brightness and light colour pre adjustable, through-wiring



WALL 68R

ART. NR./CODE	LEISTUNG/POWER	LUMEN	CRI>	KELVIN	L x B x ET/Ø x ID	Ⓢ	FARBE/COLOUR	CHF
222-00003	SYS 4W	60	90	2700/3000/4000	75 x 75 x 42	68	white	106,80
222-00004	SYS 4W	60	90	2700/3000/4000	75 x 75 x 42	68	black	106,80

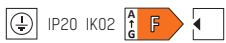

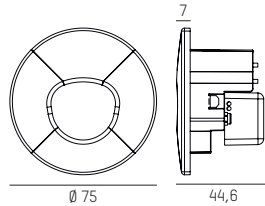

WALL 68R SINA



ART. NR./CODE	LEISTUNG/POWER	LUMEN	CRI>	KELVIN	Ø x ET/Ø x ID	⊕	FARBE/COLOUR	CHF
222-00085	SYS 4W	140	90	2700/3000/4000	75 x 45	68	white	112,80
222-00086	SYS 4W	130	90	2700/3000/4000	75 x 45	68	black	112,80

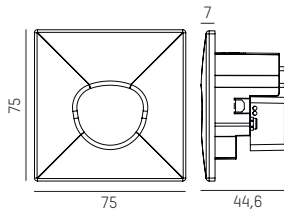
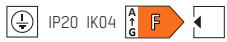

WALL 68R SINA



ART. NR./CODE	LEISTUNG/POWER	LUMEN	CRI>	KELVIN	L x B x ET/L x W x ID	⊕	FARBE/COLOUR	CHF
222-00087	SYS 4W	140	90	2700/3000/4000	75 x 75 x 45	68	white	112,80
222-00088	SYS 4W	130	90	2700/3000/4000	75 x 75 x 45	68	black	112,80

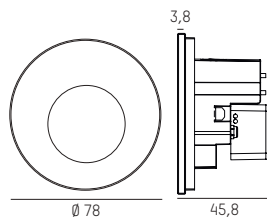

WALL 68R GLASS



ART. NR./CODE	LEISTUNG/POWER	LUMEN	CRI>	KELVIN	Ø x ET/Ø x ID	⊕	FARBE/COLOUR	CHF
222-00077	SYS 4W	80	90	2700/3000/4000	78 x 46	68	white	118,80
222-00078	SYS 4W	40	90	2700/3000/4000	78 x 46	68	black	118,80

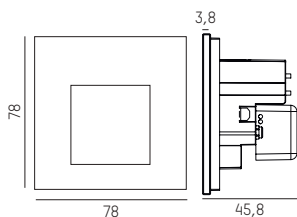

WALL 68R GLASS



ART. NR./CODE	LEISTUNG/POWER	LUMEN	CRI>	KELVIN	L x B x ET/Ø x ID	⊕	FARBE/COLOUR	CHF
222-00079	SYS 4W	85	90	2700/3000/4000	78 x 78 x 46	68	white	118,80
222-00080	SYS 4W	50	90	2700/3000/4000	78 x 78 x 46	68	black	118,80



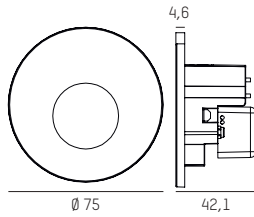

Wand-Einbauleuchte aus Aluminium, Helligkeit und Lichtfarbe vor Einbau einstellbar, Durchgangsverdrahtung, IP44

Recessed wall luminaire made of aluminium, brightness and light colour pre adjustable, through-wiring, IP44



Einstellbare Helligkeit 30/60/100%/Adjustable brightness 30/60/100%



WALL 68R IP44

ART. NR./CODE	LEISTUNG/POWER	LUMEN	CRI>	KELVIN	Ø x ET/Ø x ID	Ⓢ	FARBE/COLOUR	CHF
222-00097	SYS 4W	150	90	2700/3000/4000	75 x 42	68	white	130,80
222-00098	SYS 4W	130	90	2700/3000/4000	75 x 42	68	black	130,80

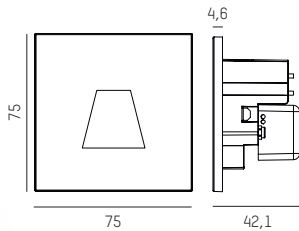

Wand-Einbauleuchte aus Aluminium, Helligkeit und Lichtfarbe vor Einbau einstellbar, Durchgangsverdrahtung, IP44

Recessed wall luminaire made of aluminium, brightness and light colour pre adjustable, through-wiring, IP44



WALL 68R IP44

ART. NR./CODE	LEISTUNG/POWER	LUMEN	CRI>	KELVIN	L x B x ET/Ø x ID	Ⓢ	FARBE/COLOUR	CHF
222-00099	SYS 4W	130	90	2700/3000/4000	75 x 75 x 42	68	white	130,80
222-00100	SYS 4W	105	90	2700/3000/4000	75 x 75 x 42	68	black	130,80



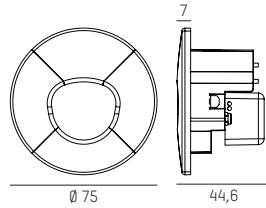

WALL 68R SINA IP44



ART. NR./CODE	LEISTUNG/POWER	LUMEN	CRI>	KELVIN	Ø x ET/Ø x ID	Ⓢ	FARBE/COLOUR	CHF
222-00105	SYS 4W	140	90	2700/3000/4000	75 x 45	68	white	136,80
222-00106	SYS 4W	130	90	2700/3000/4000	75 x 45	68	black	136,80

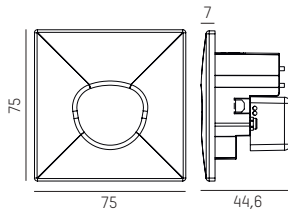

WALL 68R SINA IP44



ART. NR./CODE	LEISTUNG/POWER	LUMEN	CRI>	KELVIN	L x B x ET/L x W x ID	Ⓢ	FARBE/COLOUR	CHF
222-00107	SYS 4W	140	90	2700/3000/4000	75 x 75 x 45	68	white	136,80
222-00109	SYS 4W	130	90	2700/3000/4000	75 x 75 x 45	68	black	136,80

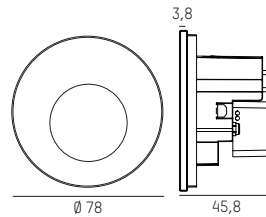
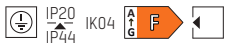

WALL 68R GLASS IP44



ART. NR./CODE	LEISTUNG/POWER	LUMEN	CRI>	KELVIN	Ø x ET/Ø x ID	Ⓢ	FARBE/COLOUR	CHF
222-00101	SYS 4W	80	90	2700/3000/4000	78 x 46	68	white	142,80
222-00102	SYS 4W	40	90	2700/3000/4000	78 x 46	68	black	142,80

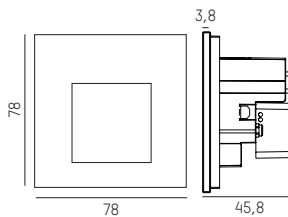

WALL 68R GLASS IP44



ART. NR./CODE	LEISTUNG/POWER	LUMEN	CRI>	KELVIN	L x B x ET/Ø x ID	Ⓢ	FARBE/COLOUR	CHF
222-00103	SYS 4W	85	90	2700/3000/4000	78 x 78 x 46	68	white	142,80
222-00104	SYS 4W	50	90	2700/3000/4000	78 x 78 x 46	68	black	142,80



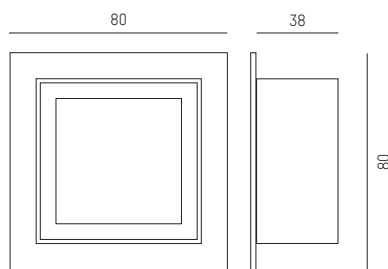

Wandeinbauleuchte, Aluminiumeloxiert, quadratisch, symmetrisch, inkl. Haltefedern für Hohlwandmontage, exkl. Konverter, Betoneinbaugehäuse separat ordern

Recessed wall luminaire, aluminium anodised, asymmetrical, incl. holding spring for cavity wall mounting, excl. driver, recessed box to be ordered separately

WINDOW I



ART. NR./CODE	LEISTUNG/POWER	mA	LUMEN	CRI>	KELVIN	B x H x ET/W x H x ID	↓	FARBE/COLOUR	CHF
305-6801p	LED 3W	250	235	80	3000	80 x 80 x 38	69 x 69	alu brushed	46,80

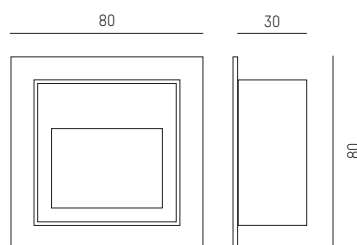

Wandeinbauleuchte aus Aluminium, quadratisch, pulverbeschichtet, asymmetrisch, Diffusor opal, Lichtaustritt direkt, inkl. Haltefedern für Hohlraummontage, exkl. Konverter, Betoneinbaugehäuse separat ordern

Recessed wall luminaire, die-cast aluminium, matt powder-coated with fine textured paint, asymmetrical light exit, opal diffuser, excl. converter, recessed box to be ordered separately

PAN



ART. NR./CODE	LEISTUNG/POWER	mA	LUMEN	CRI>	KELVIN	B x H x ET/W x H x ID	↓	FARBE/COLOUR	CHF
305-0130380003005	LED 3W	250	155	80	3000	80 x 80 x 62	69 x 69	white	54,00
305-0130380003004	LED 3W	250	155	80	3000	80 x 80 x 62	69 x 69	silver	54,00
305-0130380003006	LED 3W	250	155	80	3000	80 x 80 x 62	69 x 69	black	54,00



BETONEINBAUGEHÄUSE/CONCRETE HOUSING



ART. NR./CODE	INFO	B x H x T/W x H x ID	ET L x B x H/ID x L x W x H	CHF
305-5058	Aus verzinktem Blech, inkl. Einputzrahmen, passend für WINDOW und PAN nicht für Sichtbeton geeignet/ made of galvanised sheet, incl. plastering frame, suitable for WINDOW I and PAN not suitable for exposed concrete	142 x 138 x 38	140 x 125 x 50	27,96

KONVERTER/DRIVER



ART. NR./CODE	INFO	WATT	mA	V DC	V AC	L x B x H/L x W x H	FARBE/COLOUR	CHF
24-127719	on/off	6W	250	23	230	42 x 40 x 22	black	23,76

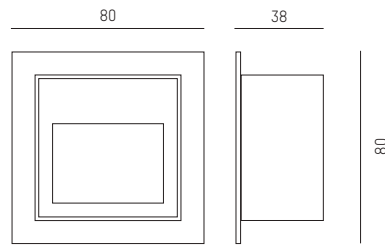

Wandeinbauleuchte, Aluminium eloxiert, quadratisch, asymmetrisch, inkl. Haltefedern für Hohlwandmontage, exkl. Konverter, Betoneinbaugehäuse separat ordern

Recessed wall luminaire, aluminium anodised, asymmetrical, incl. holding spring for cavity wall mounting, excl. driver, recessed box to be ordered separately



WINDOW II

ART. NR./CODE	LEISTUNG/POWER	mA	LUMEN	CRI>	KELVIN	B x H x ET/W x H x ID	U	FARBE/COLOUR	CHF
305-6800p	LED 3W	250	165	80	3000	80 x 80 x 38	69 x 69	alu brushed	46,80



STROMSCHIENEN
TRACKS





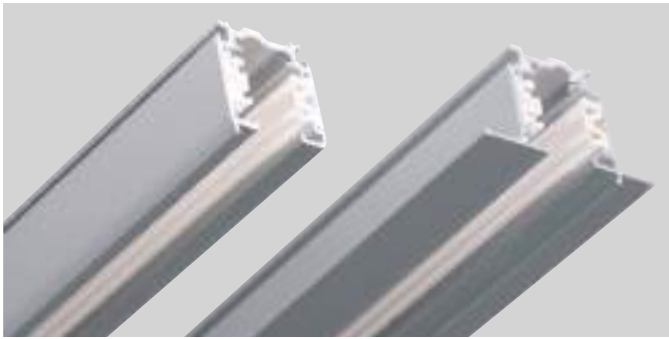

3-PHASEN SCHIENE
3-PHASE TRACK

3-Phasen Stromschiene aus Aluminiumprofil, Oberfläche pulverbeschichtet, Installation als Aufbau, Einbau- und Pendelmontage
· Zubehör separat ordern

3-phase rail made of aluminium, surface powder-coated, surface, recessed or suspended mount, Order accessories separately

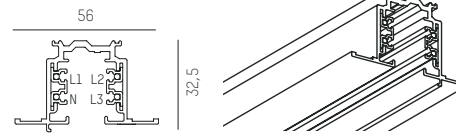

3-PHASEN SCHIENE AUFBAU/ABGEHÄNGT
3-PHASE TRACK SURFACE/PENDANT

ART. NR./CODE	LÄNGE/LENGHT	CHF
208-1910410X	1000 mm	40,44
208-1910420X	2000 mm	80,40
208-1910430X	3000 mm	120,72
208-1910440X	4000 mm	160,80

3-PHASEN SCHIENE EINBAU
3-PHASE TRACK RECESSED

ART. NR./CODE	LÄNGE/LENGHT	CHF
208-1910510X	1000 mm	47,76
208-1910520X	2000 mm	95,28
208-1910530X	3000 mm	142,80



ENDKAPPE/END PIECE

Alle Stromschienen müssen mit einer Endkappe versehen werden!
All track endings have to be equipped with endpieces!



ART. NR./CODE	CHF
208-1917041X	1,56

BIEGEWERKZEUG/BENDING TOOL

Zum Biegen der Stromleiter bei gekürzter Schiene für easy conductor bending with shortened rails

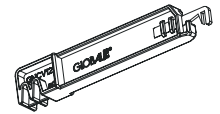

ART. NR./CODE	CHF
208-19135121	18,84

ENDEINSPEISUNG/END POWER FEED

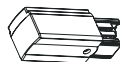

ART. NR./CODE	LÄNGE/LENGHT	CHF
208-1917011X	66 mm	13,20



Schutzleiter rechts/Earth right

ENDEINSPEISUNG/END POWER FEED



ART. NR./CODE	LÄNGE/LENGHT	CHF
208-1917012X	66 mm	13,20

Schutzleiter links/Earth left

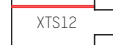

MITTELSPEISUNG/CENTER POWER FEED



ART. NR./CODE	LÄNGE/LENGHT	CHF
208-1917014X	100 mm	30,00

Schutzleiter links/Earth left Schutzleiter rechts/Earth right



ERGÄNZEN SIE DIE ARTIKELNUMMER/COMPLETE CODE FOR TRACK

X = FARBE/COLOUR

G grey = 1	S black = 2	W white = 3
-------------------	--------------------	--------------------

LINEARVERBINDER ELEKTRISCH/ LINEAR JUNCTION ELECTRIC

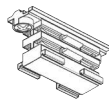

ART. NR./CODE	CHF
208-1917021X	10,68

FLEXVERBINDER/FLEXIBLE JUNCTION

biegbar 0 - 360° / bendable 0 - 360° for easy conductor bending

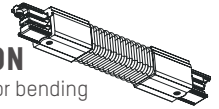

ART. NR./CODE	LÄNGE/LENGHT	CHF
208-1917023X	1782 mm	40,80



WINKEL-VERBINDER/FLEXIBLE-JUNCTION

Mit Einspeisemöglichkeit/with optional power feed

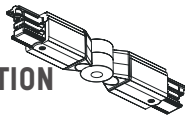

ART. NR./CODE	LÄNGE/LENGHT	CHF
208-1917024X	160 mm	40,80

X-VERBINDER/X-JUNCTION

Mit Einspeisemöglichkeit/with optional power feed

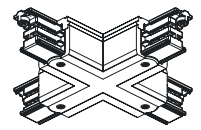

ART. NR./CODE	L x B/L x W	CHF
208-1917038X	100 x 100 mm	64,80

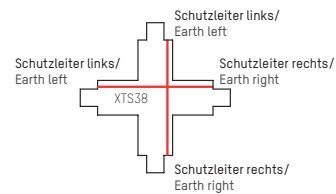

L-VERBINDER/L-JUNCTION

Mit Einspeisemöglichkeit/with optional power feed

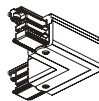

ART. NR./CODE	L x B/L x W	CHF
208-1917034X	66 x 66 mm	33,60

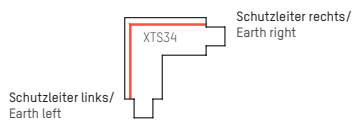

L-VERBINDER/L-JUNCTION

Mit Einspeisemöglichkeit/with optional power feed

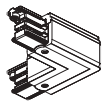

ART. NR./CODE	L x B/L x W	CHF
208-1917035X	66 x 66 mm	33,60

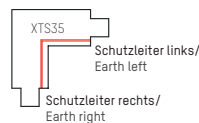

T-VERBINDER/T-JUNCTION

Mit Einspeisemöglichkeit/with optional power feed

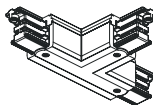

ART. NR./CODE	L x B/L x W	CHF
208-1917036X	100 x 66 mm	50,40

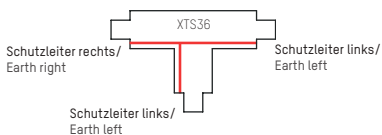

T-VERBINDER/T-JUNCTION

Mit Einspeisemöglichkeit/with optional power feed

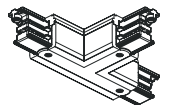

ART. NR./CODE	L x B/L x W	CHF
208-1917037X	100 x 66 mm	50,40

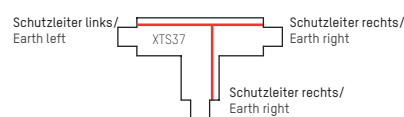

T-VERBINDER/T-JUNCTION

Mit Einspeisemöglichkeit/with optional power feed

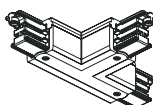

ART. NR./CODE	L x B/L x W	CHF
208-1917039X	100 x 66 mm	50,40

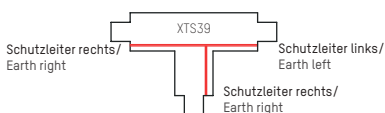

T-VERBINDER/T-JUNCTION

Mit Einspeisemöglichkeit/with optional power feed

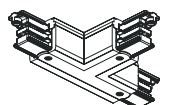

ART. NR./CODE	L x B/L x W	CHF
208-1917040X	100 x 66 mm	50,40

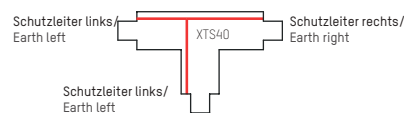

ERGÄNZEN SIE DIE ARTIKELNUMMER/COMPLETE CODE FOR TRACK

X = FARBE/COLOUR

G grey = 1

S black = 2

W white = 3

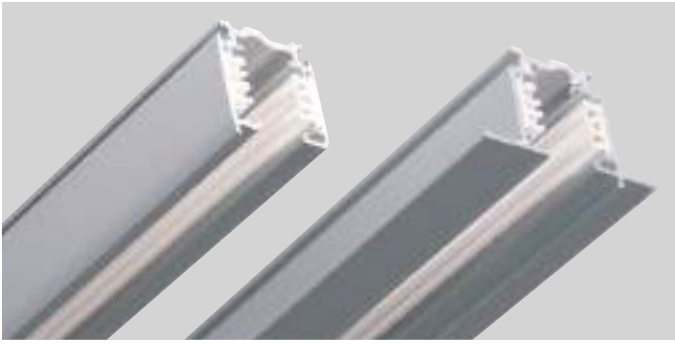

**3-PHASEN SCHIENE AUFBAU-ABGEHÄNGT DALI/
3-PHASE TRACK SURFACE-PENDANT DALI**

ART. NR./CODE	LÄNGE/LENGHT	CHF
208-1910610X	1000 mm	46,80
208-1910620X	2000 mm	93,24
208-1910630X	3000 mm	140,04
208-1910640X	4000 mm	186,60



ENDKAPPE/END PIECE

Alle Stromschienen müssen mit einer Endkappe versehen werden!
All track endings have to be equipped with endpieces!



ART. NR./CODE	CHF
208-1917041X	1,56

ENDEINSPEISUNG/END POWER FEED

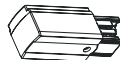

ART. NR./CODE	LÄNGE/LENGHT	CHF
208-191c611X	90 mm	26,16



Schutzleiter rechts/Earth right

MITTELSPEISUNG/CENTER POWER FEED



ART. NR./CODE	LÄNGE/LENGHT	CHF
208-191nc614X	150 mm	57,60

Schutzleiter links/Earth left Schutzleiter rechts/Earth right



**3-PHASEN SCHIENE PULSE DALI/
3-PHASE TRACK PULSE DALI**

3-Phasen Stromschiene aus Aluminiumprofil, Oberfläche pulverbeschichtet, Installation als Aufbau, Einbau- und Pendelmontage, Zubehör separat ordern

3-phase rail made of aluminium, surface powder-coated, surface, recessed or suspended mount · Order accessories separately



**3-PHASEN SCHIENE EINBAU DALI/
3-PHASE TRACK RECESSED DALI**

ART. NR./CODE	LÄNGE/LENGHT	CHF
208-1910650X	1000 mm	54,60
208-1910660X	2000 mm	109,08
208-1910670X	3000 mm	163,20

BIEGEWERKZEUG/BENDING TOOL

Zum Biegen der Stromleiter bei gekürzter Schiene/
for easy conductor bending with shortened rails

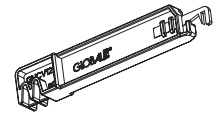

ART. NR./CODE	CHF
208-19135121	18,84

ENDEINSPEISUNG/END POWER FEED



ART. NR./CODE	LÄNGE/LENGHT	CHF
208-191c612X	90 mm	26,16

Schutzleiter links/Earth left

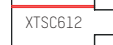

ERGÄNZEN SIE DIE ARTIKELNUMMER/COMPLETE CODE FOR TRACK

X = FARBE/COLOUR

G grey = 1	S black = 2	W white = 3
-------------------	--------------------	--------------------

LINEARVERBINDER ELEKTRISCH/ LINEAR JUNCTION ELECTRIC

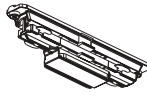

ART. NR./CODE	CHF
208-191d621X	16,56

FLEXVERBINDER/FLEXIBLE JUNCTION

biegbar 0 - 360° / bendable 0 - 360° for easy conductor bending

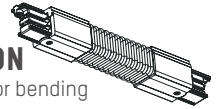

ART. NR./CODE	LÄNGE/LENGHT	CHF
208-191c623X	223 mm	87,12



X-VERBINDER/X-JUNCTION

Mit Einspeisemöglichkeit/with optional power feed

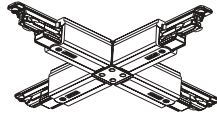

ART. NR./CODE	L x B/L x W	CHF
208-191nc638X	150 x 150 mm	116,40

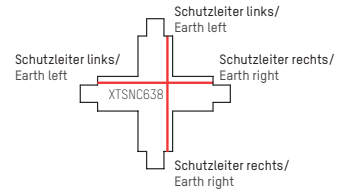

L-VERBINDER/L-JUNCTION

Mit Einspeisemöglichkeit/with optional power feed

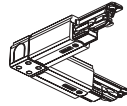

ART. NR./CODE	L x B/L x W	CHF
208-191nc634X	91 x 91 mm	57,60

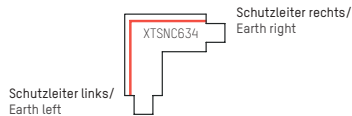

L-VERBINDER/L-JUNCTION

Mit Einspeisemöglichkeit/with optional power feed

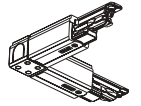

ART. NR./CODE	L x B/L x W	CHF
208-191nc635X	91 x 91 mm	57,60

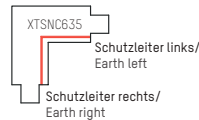

T-VERBINDER/T-JUNCTION

Mit Einspeisemöglichkeit/with optional power feed

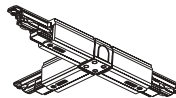

ART. NR./CODE	L x B/L x W	CHF
208-191nc636X	150 x 91 mm	87,60

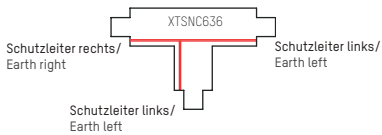

T-VERBINDER/T-JUNCTION

Mit Einspeisemöglichkeit/with optional power feed

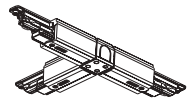

ART. NR./CODE	L x B/L x W	CHF
208-191nc637X	150 x 91 mm	87,60

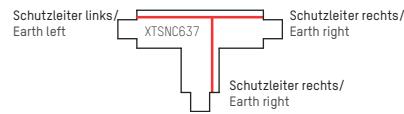

T-VERBINDER/T-JUNCTION

Mit Einspeisemöglichkeit/with optional power feed

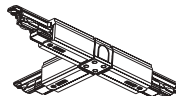

ART. NR./CODE	L x B/L x W	CHF
208-191nc639X	150 x 91 mm	87,60

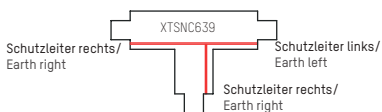

T-VERBINDER/T-JUNCTION

Mit Einspeisemöglichkeit/with optional power feed

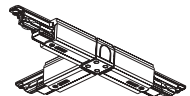

ART. NR./CODE	L x B/L x W	CHF
208-191nc640X	150 x 91 mm	87,60

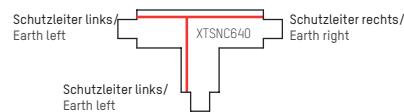

ERGÄNZEN SIE DIE ARTIKELNUMMER/COMPLETE CODE FOR TRACK

X = FARBE/COLOUR

G grey = 1

S black = 2

W white = 3

ABHÄNGESET/ SUSPENSION SET

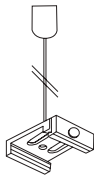

ART. NR./CODE	LÄNGE/LENGHT	FARBE/COLOUR	CHF
208-19003	1500 mm	□ white	12,00
208-19002	1500 mm	■ black	12,00
208-19001	1500 mm	■ grey	12,00

MONTAGEBÜGEL/ INSTALLATION BRACKET

für 3-Phasen Einbauschiene, inkl. Schraube M 4x 60/
for 3-phase recessed track, incl screw M 4x 60

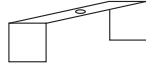

ART. NR./CODE	FARBE/COLOUR	CHF
775-hv60000808	■ grey	7,68

DECKENBEFESTIGUNG/ SURFACE FIXATION



ART. NR./CODE	FARBE/COLOUR	CHF
208-19180116	□ white	7,68
208-19180115	■ black	7,68
208-19180114	■ alu brushed	7,68

SCHNELLEBEFESTIGUNG/ FAST FIXATION SET

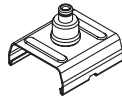

ART. NR./CODE	FARBE/COLOUR	CHF
639-as	■ nickel	8,28

DECKENBEFESTIGUNGSSET/ CEILING FIXATION

2 Halterungen + 2 Kabelfixierungen/
2 holders + 2 cable fix



ART. NR./CODE	FARBE/COLOUR	CHF
5-plsb	■ nickel	11,52

MULTIADAPTER SCHIENE/ MULTIADAPTER TRACK

Tragkraft: 10 kg/payload: 10 kg

ART. NR./CODE	L x B x H/L x W x H	FARBE/COLOUR	CHF
208-19130681	85 x 30 x 55	□ white	15,24
208-19130685	85 x 30 x 55	■ black	15,24
208-19130684	85 x 30 x 55	■ grey	15,24

MULTIADAPTER PULS DALI SCHIENE/ MULTIADAPTER PULSE DALI TRACK

Tragkraft: 10 kg/payload: 10 kg

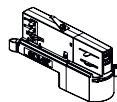

ART. NR./CODE	L x B x H/L x W x H	FARBE/COLOUR	CHF
208-19137403	105 x 30 x 55	□ white	27,00
208-19137402	105 x 30 x 55	■ black	27,00
208-19137401	105 x 30 x 55	■ grey	27,00

ABHÄNGESET/ SUSPENSION SET

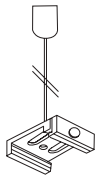

ART. NR./CODE	LÄNGE/LENGHT	FARBE/COLOUR	CHF
208-19005	3000 mm	□ white	13,92
208-19006	3000 mm	■ black	13,92
208-19004	3000 mm	■ grey	13,92

DECKENHALTERUNG/ SURFACE FIXATION

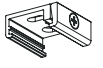

ART. NR./CODE	FARBE/COLOUR	CHF
208-19180123	□ white	3,36
208-19180122	■ black	3,36
208-19180121	■ alu brushed	3,36

STAHLSEIL/ STEEL CABLE

beliebig kürzbar, Ø 1,5 mm/
cut to any length, Ø 1,5 mm



ART. NR./CODE	LÄNGE/LENGTH	CHF
208-19190501	per Meter/ per metre	1,32

KABELABHÄNGUNGSSET/ CABLE SUSPENSION SET

beliebig kürzbar, Ø 1,2 mm/
cut to any length, Ø 1,2 mm



ART. NR./CODE	LÄNGE/LENGTH	CHF
639-s1600	1600	8,04
639-s3000	3000	8,64
639-s6000	6000	11,40

SEIL SCHNELLEBEFESTIGUNG HOCH/ CABLE FAST FIXATION SET HIGH

Bietet Platz für ein 20mm Installationsrohr zw. Stromschiene und Befestigungsset; Stahlseil und Deckenbefestigungsset separat ordern/
Allows space for a 20mm installation pipe between the busbar and the fixing set; order steel cable & ceiling fixation separately



ART. NR./CODE	FARBE/COLOUR	CHF
639-ash	■ nickel	16,68

MULTIADAPTER SCHIENE/ MULTIADAPTER TRACK

Tragkraft: 5 kg/payload: 5 kg

ART. NR./CODE	L x B x H/L x W x H	FARBE/COLOUR	CHF
208-19130698	70 x 30 x 40	□ white	14,28
208-19130697	70 x 30 x 40	■ black	14,28
208-19130696	70 x 30 x 40	■ grey	14,28

MULTIADAPTER PULS DALI SCHIENE/ MULTIADAPTER PULSE DALI TRACK

Tragkraft: 5 kg/payload: 5 kg

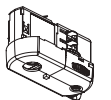

ART. NR./CODE	L x B x H/L x W x H	FARBE/COLOUR	CHF
208-19137503	105 x 30 x 40	□ white	23,16
208-19137502	105 x 30 x 40	■ black	23,16
208-19137501	105 x 30 x 40	■ grey	23,16

BLINDADAPTER SCHIENE/ BLINDADAPTER TRACK

Tragkraft: 10 kg zur Aufhängung von Leuchten/
payload: 10 kg for mounting luminaires



ART. NR./CODE	FARBE/COLOUR	CHF
208-19162173	<input type="checkbox"/> white	7,92
208-19162172	<input checked="" type="checkbox"/> black	7,92
208-19162171	<input checked="" type="checkbox"/> grey	7,92

ALUNIPPEL/ BARREL NIPPLE

L: 12 mm, zum fixation von Strahlern am Adapter/
L: 12 mm, for fixation spotlight to adapter

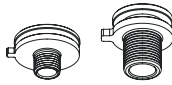

ART. NR./CODE	GRÖSSE/SIZE	FARBE/COLOUR	CHF
208-19130551	M 13 x 1	<input checked="" type="checkbox"/> alu polished	3,00
208-19130571	M 10 x 1	<input checked="" type="checkbox"/> alu polished	3,00

ZUGENTLASTUNG/ CORD GRIP

Zum Aufschrauben auf Alu-Nippel M10/
for fixation on barrel nipple M10



ART. NR./CODE	FARBE/COLOUR	CHF
208-19825016	<input type="checkbox"/> white	1,80
208-19825019	<input checked="" type="checkbox"/> black	1,80

ABDECKUNG FÜR 3-PHASENSCHIENE/ COVERPLATE FOR 3-PHASE TRACK

für T, L und X Verbinder nur für Einbauschiene/
for T, L and X junction for recessed track only

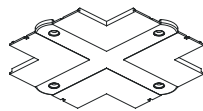

ART. NR./CODE	FARBE/COLOUR	CHF
208-19172303	<input type="checkbox"/> white	3,60
208-19172302	<input checked="" type="checkbox"/> black	3,60
208-19172302	<input checked="" type="checkbox"/> grey	3,60

ABDECKUNG FÜR 3-PHASENSCHIENE/ COVER FOR 3-PHASE TRACK

für Mittel- und Endeinspeisung nur für Einbauschiene/
for center and end power feed for recessed track only

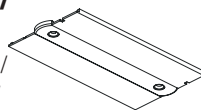

ART. NR./CODE	FARBE/COLOUR	CHF
208-19172103	<input type="checkbox"/> white	3,36
208-19172102	<input checked="" type="checkbox"/> black	3,36
208-19172101	<input checked="" type="checkbox"/> grey	3,36

ADAPTER FÜR DEKOHAKEN/ ADAPTER FOR DECO HOOK

zum einklipsen in die Schiene/
to clip into rail



ART. NR./CODE	FARBE/COLOUR	CHF
208-19160143	<input type="checkbox"/> white	1,32
208-19160142	<input checked="" type="checkbox"/> black	1,32
208-19160141	<input checked="" type="checkbox"/> grey	1,32

SCHUKO ADAPTER/ BLINDADAPTER

16A

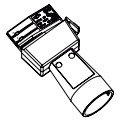

ART. NR./CODE	FARBE/COLOUR	CHF
208-19130678	<input type="checkbox"/> white	67,92
208-19130677	<input checked="" type="checkbox"/> black	67,92

ZUGENTLASTUNG/ CORD GRIP

Zum Aufschrauben auf Alu-Nippel M13/
for fixation on barrel nipple M13



ART. NR./CODE	FARBE/COLOUR	CHF
208-19130133	<input type="checkbox"/> white	2,40
208-19130132	<input checked="" type="checkbox"/> black	2,40

ABDECKUNG FÜR 3-PHASENSCHIENE PULSE DALI/ COVERPLATE FOR 3-PHASE PULSE DALI TRACK

für T, L und X Verbinder nur für Einbauschiene/
for T, L and X junction for recessed track only

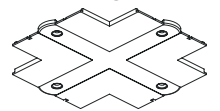

ART. NR./CODE	FARBE/COLOUR	CHF
208-191f6303	<input type="checkbox"/> white	3,84
208-191f6302	<input checked="" type="checkbox"/> black	3,84
208-191f6301	<input checked="" type="checkbox"/> grey	3,84

ABDECKUNG FÜR 3-PHASENSCHIENE PULSE DALI/ COVER FOR 3-PHASE PULSE DALI TRACK

für Mittel- und Endeinspeisung nur für Einbauschiene/
for center and end power feed for recessed track only

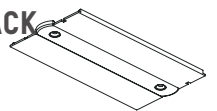

ART. NR./CODE	FARBE/COLOUR	CHF
208-191f6103	<input type="checkbox"/> white	3,60
208-191f6102	<input checked="" type="checkbox"/> black	3,60
208-191f6101	<input checked="" type="checkbox"/> grey	3,60

DEKOHAKEN/ DECO HOOK

Adapter separat ordern/
order adapter separately



ART. NR./CODE	FARBE/COLOUR	CHF
208-19160111	<input checked="" type="checkbox"/> steel	0,48



NEW

MOOVE TRACK



ART. NR./CODE	LM/BULB	FASSUNG/SOCKET	V AC	Ø x L x B/Ø x L x W	FARBE/COLOUR	CHF
222-00162	RETROFIT	QPAR 16/GU10	230	87 x 170 x 67	□ white	82,80
222-00163	RETROFIT	QPAR 16/GU10	230	87 x 170 x 67	■ black	82,80



LEUCHTMITTEL/LIGHT SOURCE

Weitere Leuchtmittel S./additional light sources P. 290

ART. NR./CODE	INFORMATION	CHF
30-752517	Core Pro LED Spot, GU10,5W, 827 Kelvin, nicht dimmbar/not dimmable	7,80

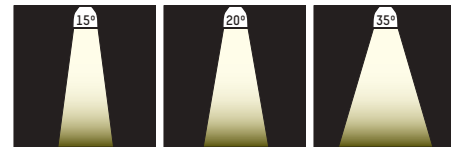

LED Stromschienenstrahler, Aluminiumdruckguss, Oberfläche pulverbeschichtet, LED Konverter in 3-Phasen Adapter integriert

Die cast aluminium LED track spotlight, surface microstructure painting, LED Driver integrated in 3 phase adapter

SHOPSTAR LEAN TRACK



ART. NR./CODE	LEISTUNG/POWER	LUMEN	Ø x H x T/Ø x H x ID	CHF
608-00301CRWWXXYv1	SYS 27W	2400-2810	95 x 150 134	ab 220,80
608-00302CRWWXXYv1	SYS 34W	2800-3280	95 x 150 134	ab 220,80



COMPLETE CODE

C = COVER	R = BEAM ANGLE	WW = LIGHT COLOUR	XX = COLOUR	Y = DIMMABLE
with glass = 0 without glass = 1	<ul style="list-style-type: none"> ☐ spot 15° = 2 ☐ medium 20° = 5 ☐ flood 35° = 8 ☐ wide flood 60° = 9 	<ul style="list-style-type: none"> ☐ W2 LED 2700K = 43 PREMIUM CRI>90 ☐ W3 LED 3000K = 49 PREMIUM CRI>90 ☐ W4 LED 4000K = 24 CRI>90 	<ul style="list-style-type: none"> ☐ G grey = 04 ☐ W white = 05 ☐ S black = 06 	<ul style="list-style-type: none"> ☐ S switchable = 0 ☐ P PULSE DALI dimm = p





NEW

MAG TRACK



ART. NR./CODE	LEISTUNG/POWER	LUMEN	CRI>	KELVIN	Ø x H/Ø x H	FARBE/COLOUR	REFL.	CHF
222-00148	SYS 16W	940	90	2700	120 x 103	white	40°	238,80
222-00149	SYS 16W	940	90	2700	120 x 103	black	40°	238,80
222-00150	SYS 16W	1040	90	3000	120 x 103	white	40°	238,80
222-00151	SYS 16W	1040	90	3000	120 x 103	black	40°	238,80



Schienenstrahler, aus Aluminium, 3-Phasen-Adapter für 3-Phasen-Schienensystem, Ausstrahlwinkel 40°, Lichtaustritt direkt, Phasenabschnitt dimmbar

Track spotlight, made of aluminium, 3-phase adapter for 3-phase track system, beam angle 40°, direct light emission, phase cut dimming



NEW

MAGIS TRACK



ART. NR./CODE	LEISTUNG/POWER	LUMEN	CRI>	KELVIN	Ø x H/Ø x H	FARBE/COLOUR	REFL.	CHF
222-00152	SYS 16W	1160	90	2700	100 x 130	white	36°	202,80
222-00153	SYS 16W	1160	90	2700	100 x 130	black	36°	202,80
222-00154	SYS 16W	1280	90	3000	100 x 130	white	36°	202,80
222-00155	SYS 16W	1280	90	3000	100 x 130	black	36°	202,80



Schienenstrahler, aus Aluminium, 3-Phasen-Adapter für 3-Phasen-Schienensystem, Ausstrahlwinkel 40°, Lichtaustritt direkt

Track spotlight, made of aluminium, 3-phase adapter for 3-phase track system, beam angle 40°, direct light emission



MAGIS DEKORRING/DECORATION RING

ART. NR./CODE	FARBE/COLOUR	CHF
276-7004	gold	14,64
276-7005	white	14,64
276-7006	black	14,64

MAGIS TAUSCHREFLEKTOR/
REPLACEMENT REFLECTOR

ART. NR./CODE	REF	CHF
276-7010	20°	19,08
276-7011	30°	19,08



TRACK SET MOOVE



ART. NR./CODE	SET INHALT/SET CONTENT	FARBE/COLOUR	CHF
55-00001	1m 3-Phasenschiene, 3x MOOVE TRACK Strahler, LM RETROFIT, FASSUNG QPAR 16/GU10, V AC 230 1m 3-phase track, 3x MOOVE TRACK Spots, bulb RETROFIT, Socket QPAR 16/GU10, V AC 230	□ white	303,60
55-00002	1m 3-Phasenschiene, 3x MOOVE TRACK Strahler, LM RETROFIT, FASSUNG QPAR 16/GU10, V AC 230 1m 3-phase track, 3x MOOVE TRACK Spots, bulb RETROFIT, Socket QPAR 16/GU10, V AC 230	■ black	303,60



3-Phasenschienenset bestehend aus: 2 oder 3 Strahler, 1m 3-Phasenschiene, Einspeisung und Endkappe

3-phase track set consisting of: 2 or 3 spotlights, 1m 3-phase track, power feed and end cap





NEW

TRACK SET MAG



ART. NR./CODE	SET INHALT/SET CONTENT	KELVIN	FARBE/COLOUR	CHF
55-00003	1m 3-Phasenschiene, 2x MAG TRACK Strahler, SYS 16W, 1290lm, CRI>90, Ref. 40° 1m 3-phase track, 2x MAG TRACK Spots, SYS 16W, 1290lm, CRI>90, Ref. 40°	2700	white	532,80
55-00004	1m 3-Phasenschiene, 2x MAG TRACK Strahler, SYS 16W, 1290lm, CRI>90, Ref. 40° 1m 3-phase track, 2x MAG TRACK Spots, SYS 2x 13W, 1290lm, CRI>90, Ref. 40°	2700	black	532,80
55-00005	1m 3-Phasenschiene, 2x MAG TRACK Strahler, SYS 16W, 1605lm, CRI>90, Ref. 40° 1m 3-phase track, 2x MAG TRACK Spots, SYS 16W, 2x 1605lm, CRI>90, Ref. 40°	3000	white	532,80
55-00006	1m 3-Phasenschiene, 2x MAG TRACK Strahler, SYS 16W, 1605lm, CRI>90, Ref. 40° 1m 3-phase track, 2x MAG TRACK Spots, SYS 16W, 1605lm, CRI>90, Ref. 40°	3000	black	532,80



LED-PANELE LED PANELS

TECNICO INDOOR





LED-Panel-Einlegeleuchte, Aluminiumrahmen weiß lackiert, mit nanoprismatischer Abdeckung aus hochwertigem PMMA (kein Vergilben), Lichtfarbe einstellbar (3000 oder 4000K), Zubehör separat ordern

LED panel recessed light, white lacquered aluminium frame, with nanoprismatic cover made of high-quality PMMA (no yellowing), adjustable light colour (3000 or 4000K), order accessories separately

RETRO 595R

ART. NR./CODE	LEISTUNG/POWER	LUMEN	CRI>	KELVIN	L x B x H/L x W x H	ET/ID	FARBE/COLOUR	REFL.	CHF
222-00159	SYS 38W	4790/4910	80	3000/4000	595 x 595 x 28	60	white	90°	94,80

RETRO 620R

ART. NR./CODE	LEISTUNG/POWER	LUMEN	CRI>	KELVIN	L x B x H/L x W x H	ET/ID	FARBE/COLOUR	REFL.	CHF
222-00160	SYS 38W	4790/4910	80	3000/4000	620 x 620 x 28	60	white	90°	94,80

RETRO 1230R

ART. NR./CODE	LEISTUNG/POWER	LUMEN	CRI>	KELVIN	L x B x H/L x W x H	ET/ID	FARBE/COLOUR	REFL.	CHF
222-00161	SYS 38W	4790/4910	80	3000/4000	1195 x 295 x 28	60	white	90°	94,80



AUFBAURAHMEN/ SURFACE MOUNTING FRAME

RETRO 595R

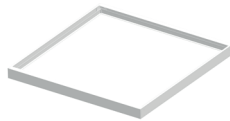

ART. NR./CODE	L x B x H/L x B x H	CHF
222-A00159	600 x 600 x 70	46,80

AUFBAURAHMEN/ SURFACE MOUNTING FRAME

RETRO 1230R



ART. NR./CODE	L x B x H/L x B x H	CHF
222-A00161	1200 x 300 x 70	52,80

KONVERTER BOX/ DRIVER BOX

RETRO 595R



ART. NR./CODE	L x B x H/L x B x H	CHF
222-A00163	250 x 75 x 45	28,80

EINBAURAHMEN 600/ RECESS MOUNTING FRAME

RETRO 595R

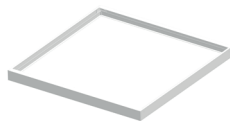

ART. NR./CODE	L x B x H/L x B x H	CHF
222-A00165	600 x 600 x 25	46,80

EINBAURAHMEN 1230/ RECESS MOUNTING FRAME

RETRO 1230R



ART. NR./CODE	L x B x H/L x B x H	CHF
222-A00167	1200 x 30 x 25	52,80

KONVERTER/DRIVER

ART. NR./CODE	INFO	WATT	mA	V DC	V AC	L x B x H/L x W x H	FARBE/COLOUR	CHF
30-880206	on/off	39W	900	44	230	156 x 43 x 30	white	18,00
24-127490	DALI	16W-38W	300-1050	54-34	230	147 x 44 x 30	white	81,36

AUFBAURAHMEN/ SURFACE MOUNTING FRAME

RETRO 620R

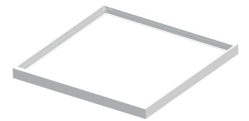

ART. NR./CODE	L x B x H/L x B x H	CHF
222-A00160	625 x 625 x 70	46,80

EINBAUKLAMMERN/ RECESSED BRACKETS

Set 6 Stk./Set 6 pcs.



ART. NR./CODE	CHF
222-A00162	10,80

ABHÄNGESET/ SUSPENSION SET

6 Stk./Set 6 pcs.



ART. NR./CODE	L	CHF
222-A00164	3000	18,00

EINBAURAHMEN 625/ RECESS MOUNTING FRAME

RETRO 620R

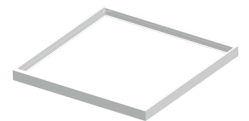

ART. NR./CODE	L x B x H/L x B x H	CHF
222-A00166	625 x 625 x 25	46,80





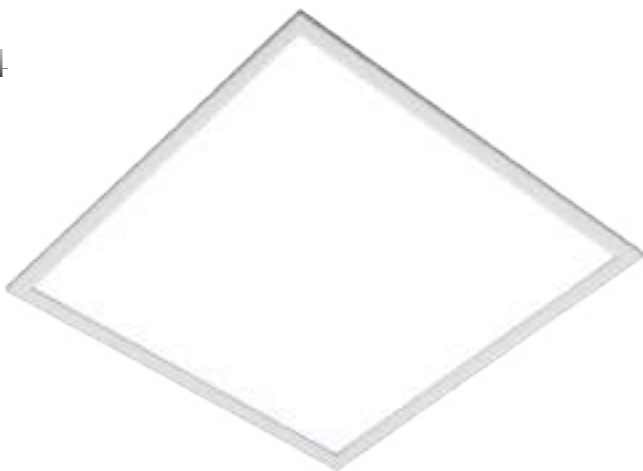

LED-Paneleinlegeleuchte, Aluminiumrahmen weiß lackiert, Modul 625, mit transluzenter PMMA Opal- oder nanoprismatischer Abdeckung, Zubehör separat ordern, zu betreiben mit 900mA oder 1200mA (Konverter separat ordern)

LED recessed panel luminaire, white aluminium frame painted aluminium frame, module 625, with translucent PMMA opal or nanoprismatic cover, order accessories order separately, to be operated with 900mA or 1200mA (order converter separately)

FIT



ART. NR./CODE	DIFFUSER/DIFFUSOR	LUMEN BEI 900mA	LUMEN BEI 1200mA	CRI>	KELVIN	L x B x H/ L x W x H	ET/ID	FARBE/ COLOUR	CHF
		LUMEN WITH 900mA	LUMEN WITH 1200mA						
		LED 35W	LED 57W						
757-625pm30fitwok	OPAL	4400	5500	80	3000	622 x 622 x 15	55	white	195,72
757-625pm40fitwok	OPAL	4500	5700	80	4000	622 x 622 x 15	55	white	195,72
757-625np30fitwok	MIKROPRISMA (UGR <19)	4100	5800	80	3000	622 x 622 x 15	55	white	191,88
757-625np40fitwok	MIKROPRISMA (UGR <19)	4500	5700	80	4000	622 x 622 x 15	55	white	191,88



KONVERTER SEPARAT ORDERN/ORDER DRIVER SEPARATELY

757-k900s	757-k1200s	nicht dimmbar/not dimmable	38,16	50,88
757-k900d	757-k1200d	DALI dimmbar/DALI dimmable	105,48	116,88



LED-Paneleinlegeleuchte, Aluminiumrahmen weiß lackiert, Modul 625, mit transluzenter PMMA Opal- oder nanoprismatischer Abdeckung, Zubehör separat ordern, zu betreiben mit 900mA oder 1200mA (Konverter separat ordern)

LED recessed panel luminaire, white aluminium frame painted aluminium frame, module 625, with translucent PMMA opal or nanoprismatic cover, order accessories separately to be operated with 900mA or 1200mA (order converter separately)

FIT LONG



ART. NR./CODE	DIFFUSER/DIFFUSOR	LUMEN/W BEI 900mA	LUMEN/W BEI 1200mA	CRI>	KELVIN	L x B x H/ L x W x H	ET/ID	FARBE/ COLOUR	CHF
		LUMEN/W WITH 900mA	LUMEN/W WITH 1200mA						
		LED 35W	LED 57W						
757-1250pm30fitwok	OPAL	4100	5500	80	3000	1246 x 310 x 15	55	white	224,88
757-1250pm40fitwok	OPAL	4100	5500	80	4000	1246 x 310 x 15	55	white	224,88
757-1250np30fitwok	MIKROPRISMA (UGR <19)	4200	5700	80	3000	1246 x 310 x 15	55	white	219,84
757-1250np40fitwok	MIKROPRISMA (UGR <19)	4200	5700	80	4000	1246 x 310 x 15	55	white	219,84



KONVERTER SEPARAT ORDERN/ORDER DRIVER SEPARATELY

757-k900s	757-k1200s	nicht dimmbar/not dimmable	38,16	50,88
757-k900d	757-k1200d	DALI dimmbar/DALI dimmable	105,48	116,88

**AUFBAURAHMEN FIT/SURFACE MOUNTING FRAME FIT**

ART. NR./CODE	INFO	L x B x H/L x W x H	FARBE/COLOUR	CHF
757-625abr	Aufbaurahmen für LED Pannelleuchte FIT, weiß lackiert, Panel wird in den Aufbaurahmen eingelegt/ Surface-mounted frame for LED panel light FIT, painted white, Panel is inserted into the mounting frame	628 x 628 x 45	<input type="checkbox"/> white	94,08

**EINBAURAHMEN FIT/RECESSED MOUNTING FRAME FIT**

ART. NR./CODE	INFO	L x B x H/L x W x H	DA L x B/ID L x W	FARBE/COLOUR	CHF
757-625ebr	Einbaurahmen für gesägte Deckenöffnungen. z.B. Trockenbaudecke etc. Für LED Pannelleuchte FIT Panel wird in den Einbaurahmen eingelegt/ Installation frame for sawn ceiling openings, e.g. drywall ceilings etc. For LED FIT Panel panel light is inserted into the installation frame	660 x 660 x 85,5	645 x 645	<input type="checkbox"/> white	78,84

**AUFBAURAHMEN FIT LONG/SURFACE-MOUNTED FRAME FIT LONG**

ART. NR./CODE	INFO	L x B x H/L x W x H	FARBE/COLOUR	CHF
757-1250abr	Aufbaurahmen für LED Pannelleuchte FIT LONG, weiß lackiert, Panel wird in den Aufbaurahmen eingelegt/ Surface-mounted frame for LED panel light FIT LONG, painted white, Panel is inserted into the mounting frame	1251 x 318 x 45	<input type="checkbox"/> white	122,04

**EINBAURAHMEN FIT LONG/INSTALLATION FRAME RECESSED FIT LONG**

ART. NR./CODE	INFO	L x B x H/L x W x H	DA L x B/ID L x W	FARBE/COLOUR	CHF
757-1250ebr	Einbaurahmen für gesägte Deckenöffnungen. z.B. Trockenbaudecke etc. Für LED Pannelleuchte FIT LONG LED Panel wird in den Einbaurahmen eingelegt/ Installation frame for sawn ceiling openings, e.g. drywall ceilings etc. For LED FIT LONG panel light LED panel is inserted into the mounting frame	1285 x 360 x 88	1270 x 335	<input type="checkbox"/> white	110,52

**SEILABHÄNGESET/CORD SUSPENSION SET**

ART. NR./CODE	INFO	L	CHF
757-zhuni2	Seilabhängeset 2m für LED Pannelleuchten FIT & FIT LONG, weiß lackiert/ cord suspension set 2m for LED panels FIT & FIT LONG, white coated	2000	29,28

**MONTAGECLIP/MOUNTING CLIP**

ART. NR./CODE	INFO	L x B x H/L x W x H	CHF
757-vestset4	Montageclipset (4 Stk.) für FIT/ Mounting clip set (4pcs.) for FIT	15 x 85 x 70	15,00

**EINSPSEISET/FEED-IN SET**

ART. NR./CODE	INFO	L	QUERSCHNITT/CROSS SECTION	FARBE/COLOUR	CHF
757-bk3w	Einspeiseset für LED Pannelleuchte FIT & FIT LONG bestehend aus: Baldachin weiß inkl. Zugentlastung transp., Baldachin: 80 x 80 x 30 mm/ Power supply set for LED panel light FIT & FIT LONG consisting of: Canopy white incl. Transparent strain relief, Canopy: 80 x 80 x 30 mm	2200	3x 0,75 mm	<input type="checkbox"/> white	22,92
757-bk5w		2200	5x 0,75 mm	<input type="checkbox"/> white	31,80



LED Hängeleuchte aus Aluminium, Oberfläche lackiert, Abdeckung mit Mikroprismenoptik, sehr breitstrahlender Indirektanteil, inkl. 2500mm Abhängung und Baldachin, L 500 x B 75 x H 38mm

LED pendant from aluminium, surface laquered, cover with micro-prismatic optik, very wide indirect light beam, incl. 2500mm suspension and canopy, L 500 x W 75 x H 38mm
Canopy: Ø 63, H 44

RUBE PDI



ART. NR./CODE	LEISTUNG/POWER	LUMEN	CRI>	KELVIN	L x B x H/L x W x H	AUSFÜHRUNG/DIMM	FARBE/COLOUR	CHF
757-lr1203700s	SYS 35W	3500	80	3000	1195 x 295 x 15	SCHALTBAR/SWITCHABLE	white	392,88
757-lr1203700dali	SYS 35W	3500	80	3000	1195 x 295 x 15	DALI DIMM	white	479,40
757-lr1204700s	SYS 35W	3500	80	4000	1195 x 295 x 15	SCHALTBAR/SWITCHABLE	white	392,88
757-lr1204700dali	SYS 35W	3500	80	4000	1195 x 295 x 15	DALI DIMM	white	479,40
757-lr1203700bs	SYS 35W	3500	80	3000	1195 x 295 x 15	SCHALTBAR/SWITCHABLE	black	392,88
757-lr1203700bdali	SYS 35W	3500	80	3000	1195 x 295 x 15	DALI DIMM	black	479,40
757-lr1204700bs	SYS 35W	3500	80	4000	1195 x 295 x 15	SCHALTBAR/SWITCHABLE	black	392,88
757-lr1204700bdali	SYS 35W	3500	80	4000	1195 x 295 x 15	DALI DIMM	black	479,40
757-lr12031050s	SYS 54W	5800	80	3000	1195 x 295 x 15	SCHALTBAR/SWITCHABLE	white	392,88
757-lr12031050dali	SYS 54W	5800	80	3000	1195 x 295 x 15	DALI DIMM	white	479,40
757-lr12041050s	SYS 54W	5800	80	4000	1195 x 295 x 15	SCHALTBAR/SWITCHABLE	white	392,88
757-lr12041050dali	SYS 54W	5800	80	4000	1195 x 295 x 15	DALI DIMM	white	479,40
757-lr12031050bs	SYS 54W	5800	80	3000	1195 x 295 x 15	SCHALTBAR/SWITCHABLE	black	392,88
757-lr12031050bdali	SYS 54W	5800	80	3000	1195 x 295 x 15	DALI DIMM	black	479,40
757-lr12041050bs	SYS 54W	5800	80	4000	1195 x 295 x 15	SCHALTBAR/SWITCHABLE	black	392,88
757-lr12041050bdali	SYS 54W	5800	80	4000	1195 x 295 x 15	DALI DIMM	black	479,40
757-lr15031050s	SYS 49W	5100	80	3000	1495 x 295 x 15	SCHALTBAR/SWITCHABLE	white	512,76
757-lr15031050dali	SYS 49W	5100	80	3000	1495 x 295 x 15	DALI DIMM	white	599,28
757-lr15041050s	SYS 49W	5100	80	4000	1495 x 295 x 15	SCHALTBAR/SWITCHABLE	white	512,76
757-lr15041050dali	SYS 49W	5100	80	4000	1495 x 295 x 15	DALI DIMM	white	599,28
757-lr15031050bs	SYS 49W	5100	80	3000	1495 x 295 x 15	SCHALTBAR/SWITCHABLE	black	512,76
757-lr15031050bdali	SYS 49W	5100	80	3000	1495 x 295 x 15	DALI DIMM	black	599,28
757-lr15041050bs	SYS 49W	5100	80	4000	1495 x 295 x 15	SCHALTBAR/SWITCHABLE	black	512,76
757-lr15041050bdali	SYS 49W	5100	80	4000	1495 x 295 x 15	DALI DIMM	black	599,28
757-lr15031400s	SYS 62W	6500	80	3000	1495 x 295 x 15	SCHALTBAR/SWITCHABLE	white	512,76
757-lr15031400dali	SYS 62W	6500	80	3000	1495 x 295 x 15	DALI DIMM	white	601,32
757-lr15041400s	SYS 62W	6500	80	4000	1495 x 295 x 15	SCHALTBAR/SWITCHABLE	white	512,76
757-lr15041400dali	SYS 62W	6500	80	4000	1495 x 295 x 15	DALI DIMM	white	601,32
757-lr15031400bs	SYS 62W	6500	80	3000	1495 x 295 x 15	SCHALTBAR/SWITCHABLE	black	512,76
757-lr15031400bdali	SYS 62W	6500	80	3000	1495 x 295 x 15	DALI DIMM	black	599,28
757-lr15041400bs	SYS 62W	6500	80	4000	1495 x 295 x 15	SCHALTBAR/SWITCHABLE	black	512,76
757-lr15041400bdali	SYS 62W	6500	80	4000	1495 x 295 x 15	DALI DIMM	black	599,28





DECKENLEUCHTEN
CEILING LIGHTS

TECNICO OUTDOOR



TECNICO OUTDOOR

PRODUKTÜBERSICHT

TECNICO OUTDOOR



IVY ROUND R
S. 174/P. 174



CHICCO ROUND
S. 174/P. 174



IVY SQUARE R
S. 176/P. 176



CHICCO SQUARE
S. 176/P. 176



NONA MINI
S. 179/P. 179



NONA
S. 179/P. 179



FORIS SD
S. 181/P. 181



WILLIAM SD
S. 181/P. 181



FORIS W
S. 183/P. 183



FORIS DOUBLE W
S. 183/P. 183



WILLIAM W
S. 183/P. 183



SOPO ROUND M
S. 185/P. 185



SOPO ROUND L
S. 185/P. 185



SOPO SQUARE M
S. 185/P. 185



SOPO SQUARE L
S. 185/P. 185



TURN 2 SD GU10
S. 186/P. 186



FYNN O SD
S. 186/P. 186



LINE 25W
S. 188/P. 188



LINE 25 DOUBLE
S. 188/P. 188



LINE 50W
S. 188/P. 188



LINE 50 DOUBLE
S. 188/P. 188



WADO W
S. 190/P. 190



WADO DOUBLE W
S. 190/P. 190



CORBA ROUND W
S. 191/P. 191



CORBA SQUARE W
S. 191/P. 191



NEXT
S. 192/P. 192



BEN ROUND W
S. 192/P. 192



BEN SQUARE W
S. 192/P. 192



PARE W
S. 194/P. 194



NELL W
S. 195/P. 195



FOCO W
S. 195/P. 195



ZEON W
S. 196/P. 196



FYNN C W
S. 196/P. 196



KODA TEN ONE
S. 198/P. 198



KODA TEN TWO
S. 198/P. 198

INDEX

TECNICO OUTDOOR

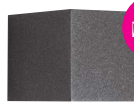

NEW

TEN STRETTO
S. 198/P. 198



NEW

KODA TWENTY ONE
S. 198/P. 198



NEW

KODA TWENTY TWO
S. 198/P. 198



NEW

KODA THIRTY ONE
S. 199/P. 199



NEW

KODA THIRTY TWO
S. 199/P. 199



NEW

CADO MINI W
S. 200/P. 200



NEW

CADO W
S. 201/P. 201



NEW

MONA MINI F
S. 204/P. 204



NEW

MONA F
S. 204/P. 204



YARA ROUND F
S. 206/P. 206



YARA SQUARE F
S. 206/P. 206



ZEON F
S. 207/P. 207



BOOPER F
S. 208/P. 208



ALIAR F
S. 208/P. 208



NEW

WILLIAM F
S. 211/P. 211



FYNN CP F
S. 211/P. 211



CHOPA F
S. 214/P. 214



HARK
S. 214/P. 214



NEW

FORIS F
S. 215/P. 215



MICRO RODIO SYM.
S. 216/P. 216



MICRO RODIO L SYM.
S. 216/P. 216



MINI RODIO SYM.
S. 217/P. 217



RODIO SYM LED
S. 217/P. 217



ZUBEHÖR/ACCESSOIRES
S. 218/P. 218

SCHUTZZONEN

● ZONE 1 | IP23

● ZONE 2 | IP44

● ZONE 3 | IP65

● ZONE 4 | IP67

IP23

geschützt gegen Sprühwasser/
Protected against water spray

IP44

geschützt gegen Spritzwasser/
Protected against splash water

IP65

geschützt gegen Strahlwasser/
Protected against water jets

IP67

geschützt gegen zeitweises Eintauchen/
Protected against temporary immersion

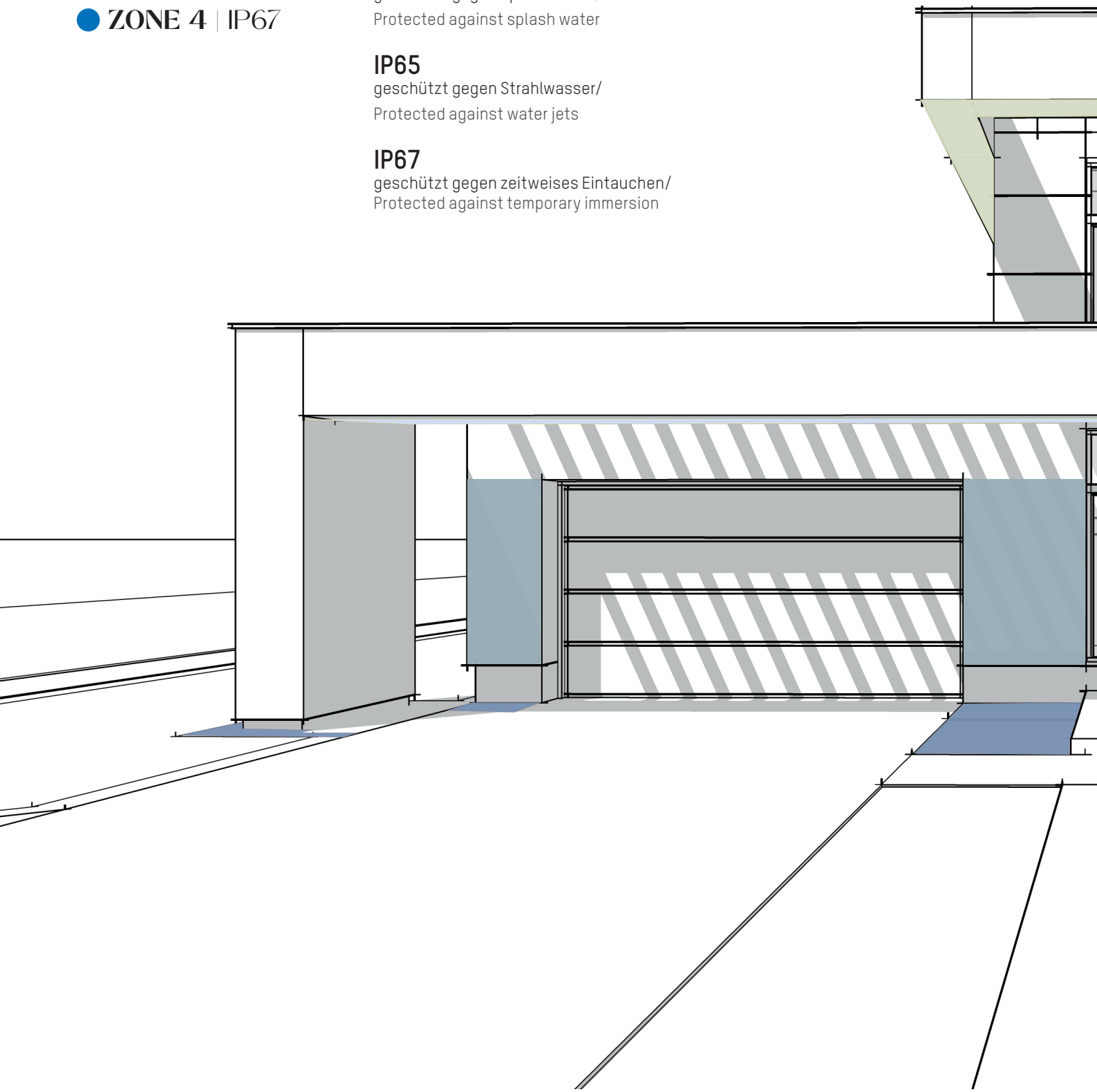

PROTECTION ZONES

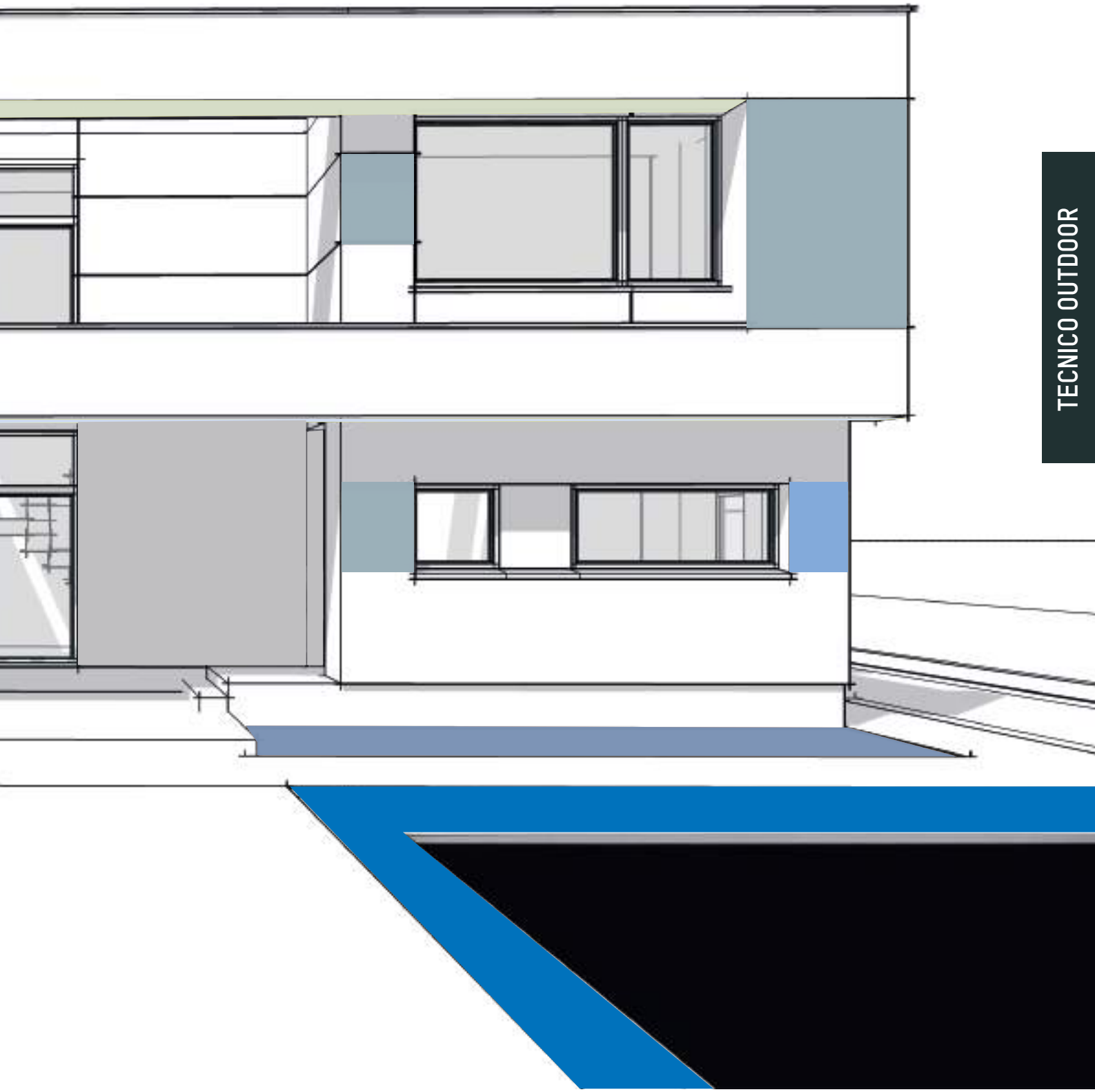

TECNICO OUTDOOR

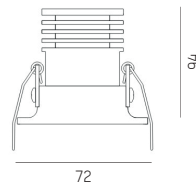

Einbaustrahler, Aluminiumdruckguss, Feinstruktur matt pulverbeschichtet, rund, mit zurückversetzter Lichtquelle, exkl. Konverter

Recessed spotlight, die-cast aluminium, powder-coated, with recessed light source, 2 beam angles, excl. driver

IVY ROUND R



ART. NR./CODE	LEISTUNG/POWER	mA	LUMEN	CRI>	KELVIN	Ø x ET/Ø x ID	Ⓢ	FARBE/COLOUR	REFL.	CHF
472-0260790203005	LED 7W	200	700	90	3000	72 x 94	60	white	20°	70,80
472-0260790203006	LED 7W	200	660	90	3000	72 x 94	60	black	20°	70,80
472-0260790403005	LED 7W	200	640	90	3000	72 x 94	60	white	40°	70,80
472-0260790403006	LED 7W	200	630	90	3000	72 x 94	60	black	40°	70,80



KONVERTER/DRIVER



ART. NR./CODE	INFO	WATT	mA	V DC	V AC	L x B x H/L x W x H	FARBE/COLOUR	CHF
30-880006	on/off	8,5W	200	44	230	156 x 43 x 30	white	15,60
24-151395	DALI	9W	180	50	230	108 x 52 x 22	white	69,84

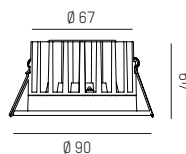

Einbaustrahler, Aluminiumdruckguss, Feinstruktur matt pulverbeschichtet, zurückversetzte Lichtquelle, exkl. Konverter

Recessed spotlight, die-cast aluminium, powder-coated, recessed light source, excl. driver

CHICCO ROUND



ART. NR./CODE	LEISTUNG/POWER	mA	LUMEN	CRI>	KELVIN	Ø x ET/Ø x ID	Ⓢ	FARBE/COLOUR	REFL.	CHF
308-0010790302704	LED 7W	350	530	90	2700	90 x 80	78	silver	30°	64,80
308-0010790302705	LED 7W	350	540	90	2700	90 x 80	78	white	30°	64,80
308-0010790302706	LED 7W	350	510	90	2700	90 x 80	78	black	30°	64,80
308-0010790303004	LED 7W	350	560	90	3000	90 x 80	78	silver	30°	64,80
308-0010790303005	LED 7W	350	590	90	3000	90 x 80	78	white	30°	64,80
308-0010790303006	LED 7W	350	560	90	3000	90 x 80	78	black	30°	64,80



KONVERTER/DRIVER



ART. NR./CODE	INFO	WATT	mA	V DC	V AC	L x B x H/L x W x H	FARBE/COLOUR	CHF
30-880006	on/off	8,5W	200	44	230	156 x 43 x 30	white	15,60
24-151403	DALI	17W	350	49	230	111 x 52 x 22	white	68,64



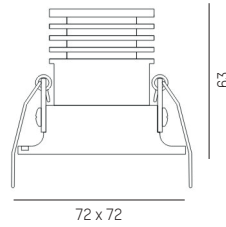

Einbaustrahler, Aluminiumdruckguss, Feinstruktur matt pulverbeschichtet, runder Deckenausschnitt, zurückversetzte Lichtquelle, exkl. Konverter

Recessed spotlight, die-cast aluminium, powder-coated, recessed light source, excl. driver

IVY SQUARE R



ART. NR./CODE	LEISTUNG/POWER	mA	LUMEN	CRI>	KELVIN	L x B x ET/L x W x ID	Ⓢ	FARBE/COLOUR	REFL.	CHF
472-0270790203005	LED 7W	200	700	90	3000	72 x 72 x 94	60	white	20°	76,80
472-0270790203006	LED 7W	200	660	90	3000	72 x 72 x 94	60	black	20°	76,80
472-0270790403005	LED 7W	200	640	90	3000	72 x 72 x 94	60	white	40°	76,80
472-0270790403006	LED 7W	200	630	90	3000	72 x 72 x 94	60	black	40°	76,80



KONVERTER/DRIVER



ART. NR./CODE	INFO	WATT	mA	V DC	V AC	L x B x H/L x W x H	FARBE/COLOUR	CHF
30-880006	on/off	8,5W	200	44	230	156 x 43 x 30	white	15,60
24-151395	DALI	9W	180	50	230	108 x 52 x 22	white	69,84

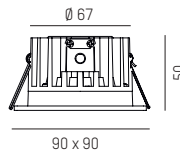

Einbaustrahler, Aluminiumdruckguss, Feinstruktur matt pulverbeschichtet, zurückversetzte Lichtquelle, exkl. Konverter

Recessed spotlight, die-cast aluminium, powder-coated, with recessed light source, 2 beam angles, excl. driver

CHICCO SQUARE



ART. NR./CODE	LEISTUNG/POWER	mA	LUMEN	CRI>	KELVIN	L x B x ET/L x W x ID	Ⓢ	FARBE/COLOUR	REFL.	CHF
308-0020790302704	LED 7W	350	530	90	2700	90 x 90 x 80	78	silver	30°	64,80
308-0020790302705	LED 7W	350	540	90	2700	90 x 90 x 80	78	white	30°	64,80
308-0020790302706	LED 7W	350	510	90	2700	90 x 90 x 80	78	black	30°	64,80
308-0020790303004	LED 7W	350	560	90	3000	90 x 90 x 80	78	silver	30°	64,80
308-0020790303005	LED 7W	350	590	90	3000	90 x 90 x 80	78	white	30°	64,80
308-0020790303006	LED 7W	350	560	90	3000	90 x 90 x 80	78	black	30°	64,80



KONVERTER/DRIVER



ART. NR./CODE	INFO	WATT	mA	V DC	V AC	L x B x H/L x W x H	FARBE/COLOUR	CHF
30-880006	on/off	15W	350	44	230	156 x 43 x 30	white	15,60
24-151403	DALI	17W	350	49	230	111 x 52 x 22	white	68,64







Deckenaufbauleuchte, gehärtetes Glas, Aluminium, low glare durch nach innen versetzte Reflektoren

Surface-mounted ceiling luminaire, tempered glass, aluminium, low glare due to reflectors offset inwards

NEW

NONA MINI



ART. NR./CODE	LEISTUNG/POWER	LUMEN	CRI>	KELVIN	Ø x H	FARBE/COLOUR	REFL.	CHF
333-00044	SYS 12W	1200	80	3000	182 x 61	anthracite	20°	178,80



Deckenaufbauleuchte, gehärtetes Glas, Aluminium, low glare durch nach innen versetzte Reflektoren, DALI dimmbar

Surface-mounted ceiling luminaire, tempered glass, aluminium, low glare due to reflectors offset inwards, DALI dimmable

NEW

NONA



ART. NR./CODE	LEISTUNG/POWER	LUMEN	CRI>	KELVIN	Ø x H	FARBE/COLOUR	REFL.	CHF
333-00045	SYS 25W	1750	80	3000	228 x 74	anthracite	20°	238,80







Deckenaufbauleuchte, Aluminium, neu mit CCT Chip, Ausstrahlwinkel 55° oder 35°, 2700K oder 3000K über DIP-Switch einstellbar

Surface-mounted ceiling light, aluminium, new with CCT chip, beam angle 55° or 35°, 2700K or 3000K adjustable via dipswitch

NEW

FORIS SD



ART. NR./CODE	LEISTUNG/POWER	LUMEN	CRI>	KELVIN	Ø x H	FARBE/COLOUR	REFL.	CHF
333-00030	SYS 11W	860/920	90	2700/3000	100 x 126	anthracite	60°	238,80



REFLEKTOR/REFLECTOR

ART. NR./CODE	FARBE/COLOUR	REFL.	CHF
333-A00030	silver	35°	22,80
333-A00031	silver	55°	22,80



ENDBLENDUNGSRING/SHUTTER RING

ART. NR./CODE	FARBE/COLOUR	CHF
341-7000	anthracite	58,80



FORIS BEAM

ART. NR./CODE	FARBE/COLOUR	CHF
333-A00032	anthracite	18,00



TECNICO OUTDOOR



Deckenaufbauleuchte, Aluminium, pulverbeschichtet, Glas transparent oder milchig

Surface-mounted ceiling light, aluminium, powder-coated, transparent or milky glass

NEW

WILLIAM SD



ART. NR./CODE	LM/BULB	FASSUNG/SOCKET	V AC	Ø x H/Ø x H	GLAS/GLASS	FARBE/COLOUR	CHF
333-00019	RETROFIT	E27	230	120 x 205	clear	anthracite brushed	154,80
333-00022	RETROFIT	E27	230	120 x 205	white	anthracite brushed	154,80







Wand-/ Deckenaufbauleuchte, Aluminiumdruckguss, opaler Diffusor aus Polycarbonat, doppelter Kabelauslass, inkl. Konverter

Wall/ceiling luminaire, die-cast aluminium, opal polycarbonate diffuser, double cable outlet, incl. driver

NEW

FORIS W



ART. NR./CODE	LEISTUNG/POWER	LUMEN	CRI>	KELVIN	Ø x B x H/Ø x W x H	FARBE/COLOUR	REFL.	CHF
333-00031	SYS 11W	900/970	90	2700/3000	100 x 146 x 119	anthracite	60°	286,80

NEW

FORIS DOUBLE W



ART. NR./CODE	LEISTUNG/POWER	LUMEN	CRI>	KELVIN	Ø x B x H/Ø x W x H	FARBE/COLOUR	REFL.	CHF
333-00032	SYS 21W	1800/1950	90	2700/3000	100 x 146 x 232	anthracite	60°	346,80

IP65 IK06 A G E ▶



REFLEKTOR/REFLECTOR

ART. NR./CODE	FARBE/COLOUR	REFL.	CHF
333-A00030	silver	35°	22,80
333-A00031	silver	55°	22,80



ENDBLENDUNGSRING/SHUTTER RING

ART. NR./CODE	FARBE/COLOUR	CHF
341-7000	anthracite	58,80



FORIS BEAM

ART. NR./CODE	FARBE/COLOUR	CHF
333-A00032	anthracite	18,00



TECNICO OUTDOOR



Wandaufbauleuchte, Aluminium, pulverbeschichtet, Glas transparent oder milchig

Surface-mounted wall light, aluminium, powder-coated, transparent or milky glass

NEW

WILLIAM W



ART. NR./CODE	LM/BULB	FASSUNG/SOCKET	V AC	Ø x B x H/Ø x W x H	GLAS/GLASS	FARBE/COLOUR	CHF
333-00020	RETROFIT	E27	230	120 x 159 x 214	clear	anthracite brushed	166,80
333-00023	RETROFIT	E27	230	120 x 159 x 214	white	anthracite brushed	166,80

IP65 ▶





Wand-/ Deckenaufbauleuchte, Aluminiumdruckguss, opaler Diffusor aus Polycarbonat, doppelter Kabelauslass, inkl. Konverter

Wall/ceiling luminaire, die-cast aluminium, opal polycarbonate diffuser, double cable outlet, incl. driver

SOPO ROUND M



ART. NR./CODE	LEISTUNG/POWER	LUMEN	CRI>	KELVIN	Ø x T	FARBE/COLOUR	CHF
100-r24190110	SYS 25W	2570	80	3000	240 x 45	anthracite	210,00
100-r24190740	SYS 25W	2570	80	3000	240 x 45	silver	210,00

SOPO ROUND L



ART. NR./CODE	LEISTUNG/POWER	LUMEN	CRI>	KELVIN	Ø x T	FARBE/COLOUR	CHF
100-r30190110	SYS 30W	2860	80	3000	300 x 49	anthracite	274,80
100-r30190740	SYS 30W	2860	80	3000	300 x 49	silver	274,80



Wand-/ Deckenaufbauleuchte, Aluminiumdruckguss, opaler Diffusor aus Polycarbonat, doppelter Kabelauslass, inkl. Konverter

Wall/ceiling luminaire, die-cast aluminium, opal polycarbonate diffuser, double cable outlet, incl. driver

SOPO SQUARE M



ART. NR./CODE	LEISTUNG/POWER	LUMEN	CRI>	KELVIN	L x B x T/L x W x D	FARBE/COLOUR	CHF
100-q24190110	SYS 25W	2755	80	3000	240 x 240 x 45	anthracite	210,00
100-q24190740	SYS 25W	2755	80	3000	240 x 240 x 45	silver	210,00

SOPO SQUARE L



ART. NR./CODE	LEISTUNG/POWER	LUMEN	CRI>	KELVIN	L x B x T/L x W x D	FARBE/COLOUR	CHF
100-q30190110	SYS 30W	2950	80	3000	300 x 300 x 49	anthracite	274,80
100-q30190740	SYS 30W	2950	80	3000	300 x 300 x 49	silver	274,80



186



Aufbaustrahler, Aluminium geätzt, 90° schwenkbar

Surface-mounted spotlight, aluminium brushed or painted, 90° swivelling

TURN 2 SD GU10



ART. NR./CODE	LM/BULB	FASSUNG/SOCKET	V AC	B x H x T/W x H x D	FARBE/COLOUR	CHF
472-256012	RETROFIT	GU10	230	88 x 90 x 115	silver	154,80
472-256011	RETROFIT	GU10	230	88 x 90 x 115	anthracite	154,80



LEUCHTMITTEL/LIGHT SOURCE

Weitere Leuchtmittel S./additional light sources P. 290

ART. NR./CODE	INFORMATION	CHF
30-752517	Core Pro LED Spot, GU10,5W, 827 Kelvin, 36° Austrahlwinkel/beam angle	7,80



Aufbauleuchte, Aluminiumdruckguss, pulverbeschichtet, Diffusor aus opalem Acryl, AC-LED

Surface-mounted luminaire, die-cast aluminium, powder-coated, opal acrylic diffuser, AC LED

FYNN O SD



ART. NR./CODE	LEISTUNG/POWER	LUMEN	CRI>	KELVIN	B x H x T/W x H x D	FARBE/COLOUR	CHF
472-260056w	SYS 10W	790	90	3000	100 x 100 x 112	white	190,80
472-260056s	SYS 10W	790	90	3000	100 x 100 x 112	silver	190,80
472-260056ag	SYS 10W	790	90	3000	100 x 100 x 112	anthracite	190,80







NEW

Wandaufbauleuchte, Aluminium, pulverbeschichtet, up/down oder up&down, 2700K oder 3000K über DIP-Switch einstellbar, Durchgangsverdrahtung, Connect Terminal

Surface-mounted wall light, aluminium, powder-coated, up/down or up&down, 2700K or 3000K adjustable via dipswitch, through-wiring, connect terminal

LINE 25W

ART. NR./CODE	LEISTUNG/POWER	LUMEN	CRI>	KELVIN	L x B x H/L x W x H	FARBE/COLOUR	CHF
333-00016	SYS 7W	1200/1050	80	2700/3000	250 x 60 x 60	anthracite	178,80



LINE 25 DOUBLE

ART. NR./CODE	LEISTUNG/POWER	LUMEN	CRI>	KELVIN	L x B x H/L x W x H	FARBE/COLOUR	CHF
333-00015	SYS 15W	2400/2100	80	2700/3000	250 x 60 x 60	anthracite	214,80



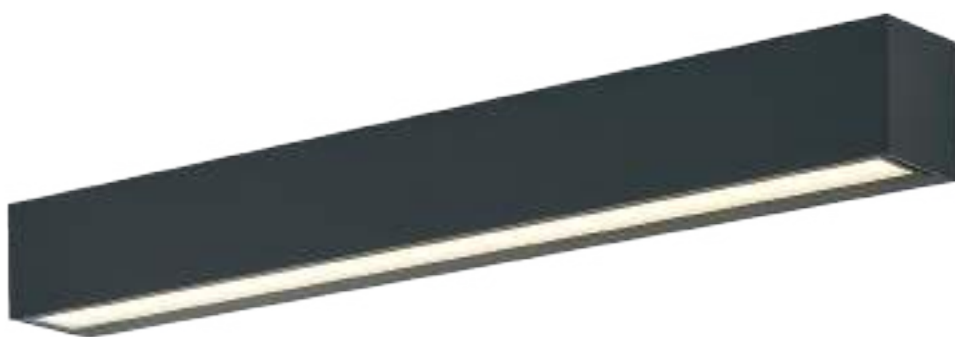

LINE 50W



ART. NR./CODE	LEISTUNG/POWER	LUMEN	CRI>	KELVIN	L x B x H/L x W x H	FARBE/COLOUR	CHF
333-00018	SYS 15W	1800/1500	80	2700/3000	500 x 60 x 60	anthracite	238,80

LINE 50 DOUBLE



ART. NR./CODE	LEISTUNG/POWER	LUMEN	CRI>	KELVIN	L x B x H/L x W x H	FARBE/COLOUR	CHF
333-00017	SYS 20W	3550/3000	80	2700/3000	500 x 60 x 60	anthracite	298,80





Wandaufbauleuchte, Aluminium, optional mit antiglare cover, Lichtaustritt direkt/ indirekt, DALI2/

Surface-mounted wall light, aluminium, optionally with antiglare cover, direct/ indirect light emission, DALI2

NEW

CORBA ROUND W direkt-indirekt/direct-indirect



BLENDEN/BLINDS

ART. NR./CODE	FARBE/COLOUR	CHF
333-A00046	■ anthracite	34,80



ART. NR./CODE	LEISTUNG/POWER	LUMEN	CRI>	KELVIN	L x B x H/L x W x H	FARBE/COLOUR	REFL.	CHF
333-00046	SYS 24W	1180	90	■ 3000	100 x 100 x 220	■ anthracite	36°	358,80



BLENDEN/BLINDS

ART. NR./CODE	FARBE/COLOUR	CHF
333-A00048	■ anthracite	34,80



CORBA SQUARE W direkt-indirekt/direct-indirect

ART. NR./CODE	LEISTUNG/POWER	LUMEN	CRI>	KELVIN	L x B x H/L x W x H	FARBE/COLOUR	REFL.	CHF
333-00048	SYS 24W	1180	90	■ 3000	100 x 100 x 220	■ anthracite	36°	358,80



Wandaufbauleuchte, Aluminium, CCT Switch 2700K/3000K, Ausstrahlwinkel 15° oder 36°, Lichtaustritt direkt/indirekt, Connect Terminal

Surface-mounted wall light, aluminium, CCT switch 2700K/3000K, beam angle 15° or 36°, direct/indirect light emission, Connect terminal

NEW

WADO W direkt/direct



ART. NR./CODE	LEISTUNG/POWER	LUMEN	CRI>	KELVIN	L x B x H/L x W x H	FARBE/COLOUR	REFL.	CHF
333-00050	SYS 12W	945/1020	90	■ 2700/■ 3000	110 x 110 x 120	■ anthracite	36°	250,80

NEW

WADO DOUBLE W direkt-indirekt/direct-indirect



ART. NR./CODE	LEISTUNG/POWER	LUMEN	CRI>	KELVIN	L x B x H/L x W x H	FARBE/COLOUR	REFL.	CHF
333-00051	SYS 20W	1890/2035	90	■ 2700/■ 3000	110 x 110 x 120	■ anthracite	36°	310,80



REFLEKTOR/REFLECTOR

ART. NR./CODE	FARBE/COLOUR	REFL.	CHF
333-A00050	■ silver	15°	22,80
333-A00051	■ silver	36°	22,80





Wandleuchte, Aluminium, Feinstruktur matt pulverbeschichtet, schwenkbarer Doppelreflektor für individuelle Lichtbildgestaltung, Lichtaustritt direkt/ indirekt, inkl. Konverter

Wall luminaire, aluminium, powder-coated, tiltable cover for individual light distribution, direct/indirect beam, incl. driver

NEXT W direkt-indirekt/direct-indirect



ART. NR./CODE	LEISTUNG/POWER	LUMEN	CRI>	KELVIN	B x H x T/W x H x D	FARBE/COLOUR	CHF
472-291008w	SYS 7W	210	90	3000	100 x 100 x 100	white	298,80
472-291008s	SYS 7W	210	90	3000	100 x 100 x 100	silver	298,80
472-291008bgngl	SYS 7W	210	90	3000	100 x 100 x 100	black/gold	346,80
472-291008ag	SYS 7W	210	90	3000	100 x 100 x 100	anthracite	298,80



Wandleuchte, Aluminiumdruckguss, pulverbeschichtet, Lichtaustritt direkt/ indirekt, inkl. Konverter

Wall luminaire, aluminium, powder-coate, round, direct/indirect beam, incl. driver

BEN ROUND W direkt-indirekt/direct-indirect



ART. NR./CODE	LEISTUNG/POWER	LUMEN	CRI>	KELVIN	B x H x T/W x H x D	FARBE/COLOUR	CHF
472-0050890003005	SYS 9W	230	90	3000	90 x 250 x 95	white	322,80
472-0050890003004	SYS 9W	230	90	3000	90 x 250 x 95	silver	322,80
472-0050890003011	SYS 9W	230	90	3000	90 x 250 x 95	anthracite	322,80



Wandleuchte, Aluminium, Feinstruktur matt pulverbeschichtet, Lichtaustritt direkt/ indirekt, inkl. Konverter

Wall luminaire, aluminium, matt powder-coated with fine textured paint, rectangular, direct/indirect beam, incl. driver

BEN SQUARE W direkt-indirekt/direct-indirect



ART. NR./CODE	LEISTUNG/POWER	LUMEN	CRI>	KELVIN	B x H x T/W x H x D	FARBE/COLOUR	CHF
472-0060890003004	SYS 9W	360	90	3000	80 x 200 x 80	silver	262,80
472-0060890003005	SYS 9W	525	90	3000	80 x 200 x 80	white	262,80
472-0060890003011	SYS 9W	320	90	3000	80 x 200 x 80	anthracite	262,80





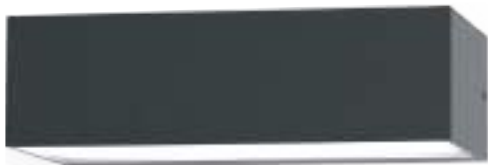

Wandleuchte, Aluminiumdruckguss, Feinstruktur matt pulverbeschichtet, satinierter Diffusor aus Polycarbonat für homogenen Lichteffect, Lichtaustritt direkt/indirekt, inkl. Konverter

Wall luminaire, die-cast aluminium, powder-coated, satined polycarbonate diffuser for homogeneous lighting effect, direct/indirect beam, incl. driver

PARE W direkt-indirekt/direct-indirect



ART. NR./CODE	LEISTUNG/POWER	LUMEN	CRI>	KELVIN	L x B x T/L x W x H	FARBE/COLOUR	REFL.	CHF
100-02190110	SYS 12W	380	90	3000	207 x 60 x 110	anthracite	2x 110°	154,80
100-02190740	SYS 12W	380	90	3000	207 x 60 x 110	silver	2x 110°	154,80





Wandleuchte, Aluminiumdruckguss, pulverbeschichtet, kugelförmig, Linse aus Glas, 80° Ausstrahlwinkel, Lichtaustritt direkt/indirekt, inkl. Konverter

Wall luminaire, die-cast aluminium, powder-coated, spherical shape, glass lens, 80° beam angle, direct/indirect beam, incl. driver

NELL W direkt-indirekt/direct-indirect



ART. NR./CODE	LEISTUNG/POWER	LUMEN	CRI>	KELVIN	Ø x T	FARBE/COLOUR	CHF
472-3729050	SYS 7W	325	90	3000	100 x 88	white	286,80
472-3729060	SYS 7W	275	90	3000	100 x 88	black	286,80



Wandleuchte, Aluminiumdruckguss, pulverbeschichtet, klare Glaslinsen für parabolischen Lichteffect, Lichtaustritt direkt/indirekt, inkl. Konverter

Wall luminaire, die-cast aluminium, powder-coated, clear glass lenses for parabolic lighting effect, direct/indirect distribution, incl. driver

FOCO W direkt-indirekt/direct-indirect



ART. NR./CODE	LEISTUNG/POWER	LUMEN	CRI>	KELVIN	L x B x H/L x W x H	FARBE/COLOUR	REFL.	CHF
100-01190110	SYS 9W	550	80	3000	121 x 107 x 78	anthracite	2x 100°	178,80
100-01190740	SYS 9W	550	80	3000	121 x 107 x 78	silver	2x 100°	178,80





Wandleuchte, Aluminiumdruckguss, pulverbeschichtet, opaler Diffusor und Klarglasabdeckung, Lichtaustritt indirekt, inkl. Konverter

Wall luminaire, die-cast aluminium, powder-coated, opal diffuser and clear glass cover, indirect beam, incl. driver

ZEON W



ART. NR./CODE	LEISTUNG/POWER	LUMEN	CRI>	KELVIN	Ø x T/Ø x D	FARBE/COLOUR	CHF
472-0561090003006	SYS 10W	320	90	3000	120 x 90	black	298,80
472-0561090003011	SYS 10W	320	90	3000	120 x 90	anthracite	298,80



Wandleuchte, Aluminiumdruckguss, pulverbeschichtet, Diffusor aus opalem Acryl, AC-LED

Wall luminaire, die-cast aluminium, powder-coated, diffuser of opal acrylic, AC-LED

FYNN C W



ART. NR./CODE	LEISTUNG/POWER	LUMEN	CRI>	KELVIN	B x H x T/W x H x D	FARBE/COLOUR	CHF
472-260055s	SYS 10W	642	90	3000	100 x 100 x 120	silver	202,80
472-260055ag	SYS 10W	642	90	3000	100 x 100 x 120	anthracite	202,80





Wandleuchte, Aluminiumdruckguss, lackiert, Diffusor aus transparentem Glas, Dichtung aus Polymerkunststoff, Kühlkörper Aluminium, Schrauben Edelstahl, inkl. Konverter

Wall light, die-cast aluminium, lacquered, diffuser made of transparent glass, polymer plastic gasket, aluminium heat sink, stainless steel screws, incl. converters

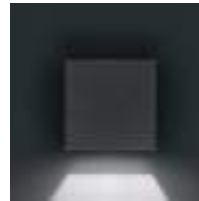

1x breit/
1x wide

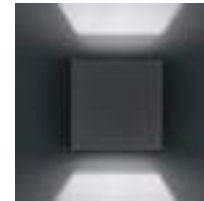

2x breit/
2x wide



1x breit-1x eng/
1x wide-1x narrow

KODA TEN ONE



ART. NR./CODE	LEISTUNG/POWER	LUMEN	CRI>	KELVIN	L x B x T/L x W x H	FARBE/COLOUR	LICHTAUSTRITT/LIGHT OUTPUT	CHF
333-00055	SYS 4W	100	80	3000	100 x 100 x 100	white	direkt/direct	202,80
333-00054	SYS 4W	100	80	3000	100 x 100 x 100	anthracite	direkt/direct	202,80

KODA TEN TWO



ART. NR./CODE	LEISTUNG/POWER	LUMEN	CRI>	KELVIN	L x B x T/L x W x H	FARBE/COLOUR	LICHTAUSTRITT/LIGHT OUTPUT	CHF
333-00057	SYS 6W	2x 96	80	3000	100 x 100 x 100	white	direkt-indirekt/direct-indirect	262,80
333-00056	SYS 6W	2x 96	80	3000	100 x 100 x 100	anthracite	direkt-indirekt/direct-indirect	262,80

KODA TEN STRETTO



ART. NR./CODE	LEISTUNG/POWER	LUMEN	CRI>	KELVIN	L x B x T/L x W x H	FARBE/COLOUR	LICHTAUSTRITT/LIGHT OUTPUT	CHF
333-00059	SYS 6W	96+17	80	3000	100 x 100 x 100	white	1x breit-1x eng/1x wide-1x narrow	274,80
333-00058	SYS 6W	96+17	80	3000	100 x 100 x 100	anthracite	1x breit-1x eng/1x wide-1x narrow	274,80



direkt/
direct



direkt-indirekt/
direct-indirect

KODA TWENTY ONE



ART. NR./CODE	LEISTUNG/POWER	LUMEN	CRI>	KELVIN	L x B x T/L x W x H	FARBE/COLOUR	LICHTAUSTRITT/LIGHT OUTPUT	CHF
333-00061	SYS 11W	492	80	3000	200 x 100 x 100	white	direkt/direct	262,80
333-00060	SYS 11W	492	80	3000	200 x 100 x 100	anthracite	direkt/direct	262,80

KODA TWENTY TWO



ART. NR./CODE	LEISTUNG/POWER	LUMEN	CRI>	KELVIN	L x B x T/L x W x H	FARBE/COLOUR	LICHTAUSTRITT/LIGHT OUTPUT	CHF
333-00063	SYS 20W	930	80	3000	200 x 100 x 100	white	direkt-indirekt/direct-indirect	322,80
333-00062	SYS 20W	930	80	3000	200 x 100 x 100	anthracite	direkt-indirekt/direct-indirect	322,80



1x breit/
1x wide2x breit/
2x wide

KODA THIRTY ONE



ART. NR./CODE	LEISTUNG/POWER	LUMEN	CRI>	KELVIN	L x B x T/L x W x H	FARBE/COLOUR	LICHTAUSTRITT/LIGHT OUTPUT	CHF
333-00065	SYS 20W	936	80	3000	300 x 100 x 100	white	direkt/direct	394,80
333-00064	SYS 20W	936	80	3000	300 x 100 x 100	anthracite	direkt/direct	394,80

KODA THIRTY TWO



ART. NR./CODE	LEISTUNG/POWER	LUMEN	CRI>	KELVIN	L x B x T/L x W x H	FARBE/COLOUR	LICHTAUSTRITT/LIGHT OUTPUT	CHF
333-00067	SYS 32W	1532	80	3000	300 x 100 x 100	white	direkt-indirekt/direct-indirect	526,80
333-00066	SYS 32W	1532	80	3000	300 x 100 x 100	anthracite	direkt-indirekt/direct-indirect	526,80



IP65





NEW

Wandaufbauleuchte, Aluminium, innen liegende Platine für optimale Entblendung, 2700K oder 3000K über DIP-Switch einstellbar, Durchgangsverdrahtung möglich

Surface-mounted wall light, aluminium, internal circuit board for optimum glare control, 2700K or 3000K adjustable via dipswitch, through-wiring possible

CADO MINI W



ART. NR./CODE	LEISTUNG/POWER	LUMEN	CRI>	KELVIN	L x B x H/L x W x H	FARBE/COLOUR	CHF
333-00052	SYS 4W	105/100	90	2700/3000	140 x 113 x 32	anthracite	178,80



CADO W



ART. NR./CODE	LEISTUNG/POWER	LUMEN	CRI>	KELVIN	L x B x H/L x W x H	FARBE/COLOUR	CHF
333-00053	SYS 9W	195/200	90	2700/3000	250 x 113 x 32	anthracite	238,80



POLLERLEUCHTEN BOLLARDS







Pollerleuchte, Aluminium, pulverbeschichtet, blendfrei, angenehme Lichtgleichmäßigkeit, breite Lichtverteilung von 10m, Durchgangsverdrahtung, inkl. Bodenplatte mit Betonanker, IP65, DALI2 dimmbar

Bollard luminaire, aluminium, powder-coated, glare-free, pleasant light uniformity, wide light distribution of 10m, through-wiring, incl. base plate with concrete anchor, IP65, DALI2 dimmable



MONA MINI F



ART. NR./CODE	LEISTUNG/POWER	LUMEN	CRI>	KELVIN	Ø x H/Ø x H	FARBE/COLOUR	CHF
333-00039	SYS 12W	550	80	3000	100 x 450	anthracite	442,80
333-00040	SYS 12W	550	80	3000	100 x 850	anthracite	478,80



MONA F



ART. NR./CODE	LEISTUNG/POWER	LUMEN	CRI>	KELVIN	Ø x H/Ø x H	FARBE/COLOUR	CHF
333-00034	SYS 23W	1060	80	3000	180 x 450	anthracite	646,80
333-00035	SYS 23W	1060	80	3000	180 x 850	anthracite	730,80







Pollerleuchte, Aluminiumdruckguss, Feinstruktur matt pulverbeschichtet, PC-Diffusor klar, 360° Ausstrahlwinkel, inkl. Konverter

Bollard luminaire, die-cast aluminium, matt powder-coated with fine textured paint, clear polycarbonate diffuser, 360° beam angle, incl. driver



YARA ROUND F



ART. NR./CODE	LEISTUNG/POWER	LUMEN	CRI>	KELVIN	Ø x H/Ø x H	FARBE/COLOUR	CHF
273-1000s	SYS 10W	685	80	3000	165 x 800	grey	430,80



YARA SQUARE F



ART. NR./CODE	LEISTUNG/POWER	LUMEN	CRI>	KELVIN	L x B x H/L x W x H	FARBE/COLOUR	CHF
273-1002s	SYS 10W	800	80	3000	150 x 150 x 800	grey	442,80

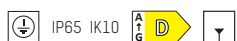







Pollerleuchte, Aluminiumdruckguss, Feinstruktur matt pulverbeschichtet, opaler Diffusor und Klarglasabdeckung, inkl. Konverter

Bollard luminaire, die-cast aluminium, matt powder-coated with fine textured paint, opal diffuser and transparent cover, incl. driver



ZEON F



ART. NR./CODE	LEISTUNG/POWER	LUMEN	CRI>	KELVIN	Ø x H/Ø x H	FARBE/COLOUR	CHF
472-0571390003006	SYS 12W	390	90	 3000	120 x 900	 black	586,80
472-0571390003011	SYS 12W	390	90	 3000	120 x 900	 anthracite	586,80





Pollerleuchte, Aluminiumdruckguss, Feinstruktur matt pulverbeschichtet, inkl. Konverter

Bollard luminaire, die-cast aluminium, matt powder-coated with fine textured paint, incl. driver



BOOPER F



ART. NR./CODE	LEISTUNG/POWER	LUMEN	CRI>	KELVIN	Ø x H	FARBE/COLOUR	CHF
472-90079500	SYS 9W	190	90	3000	80 x 600	white	358,80
472-90079900	SYS 9W	190	90	3000	80 x 600	anthracite	358,80



Pollerleuchte, Aluminiumdruckguss, Feinstruktur matt pulverbeschichtet, inkl. Konverter

Bollard luminaire, die-cast aluminium, matt powder-coated with fine textured paint, incl. driver



ALIAR F



ART. NR./CODE	LEISTUNG/POWER	LUMEN	CRI>	KELVIN	B x T x H/W x D x H	FARBE/COLOUR	CHF
472-90029600	SYS 12W	460	90	3000	80 x 150 x 600	black	346,80
472-90029900	SYS 12W	460	90	3000	80 x 150 x 600	anthracite	346,80



25

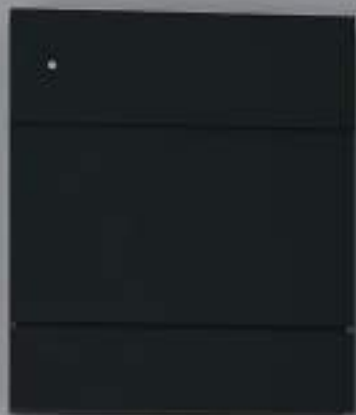





NEW

Pollerleuchte, Aluminium, pulverbeschichtet, Glas transparent oder milchig

Bollard light, aluminium, powder-coated, glass transparent or milky



WILLIAM F

ART. NR./CODE	LM/BULB	FASSUNG/SOCKET	V AC	Ø x H/Ø x H	GLAS/GLASS	FARBE/COLOUR	CHF
333-00021	RETROFIT	E27	230	120 x 850	<input type="checkbox"/> clear	<input checked="" type="checkbox"/> anthracite	238,80
333-00024	RETROFIT	E27	230	120 x 850	<input type="checkbox"/> white	<input checked="" type="checkbox"/> anthracite	238,80



IP65



LEUCHTMITTEL/LIGHT SOURCE

Weitere Leuchtmittel S./additional light sources P. 290

ART. NR./CODE	INFORMATION	CHF
30-380035	A60/CorePro LED Bulb clear, E27,7W, 827 Kelvin	5,88



Pollerleuchte, Aluminium, Feinstruktur pulverbeschichtet, Diffusor aus opalem Acryl, inkl. Konverter, AC-LED

Bollard luminaire, AC-LED, die-cast aluminium, matt powder-coated with fine textured paint, acrylic opal diffuser, incl. driver



FYNN CP F

ART. NR./CODE	LEISTUNG/POWER	LUMEN	CRI>	KELVIN	L x B x H/L x W x H	FARBE/COLOUR	CHF
472-260057ag	SYS 10W	642	90	<input checked="" type="checkbox"/> 3000	100 x 100 x 900	<input checked="" type="checkbox"/> anthracite	478,80
472-260057s	SYS 10W	642	90	<input checked="" type="checkbox"/> 3000	100 x 100 x 900	<input checked="" type="checkbox"/> silver	478,80



IP54



A photograph of a ground-mounted light fixture illuminating a tree trunk and a bush at night. The light fixture is a small, dark, cylindrical object with a bright white light emanating from its top. It is positioned on a gravel surface. The light illuminates the trunk of a tree on the right side of the frame and a bush with purple flowers in the middle ground. The background is a dark, textured wall. The overall scene is dimly lit, with the light from the fixture providing the primary illumination.

BODENAUFBAULEUCHTEN
GROUND MOUNTED LIGHTS



TECNICO OUTDOOR

**CHOPA F**

Erdspiesleuchte, Aluminiumdruckguss, pulverbeschichtet, höhenverstellbar, inkl. Konverter und 1300mm Kabel mit Stecker

Ground spike luminaire, die-cast aluminium, powder coated, height adjustable, incl. converter and 1300mm cable with plug.



ART. NR./CODE	LEISTUNG/POWER	V AC	LUMEN	CRI>	KELVIN	Ø x B x H/Ø x W x H	FARBE/COLOUR	REFL.	CHF
472-90059600	SYS 7W	230	450	90	3000	60 x 132 x 400	black	38°	262,80

**HARK**

Aufbaustrahler, Aluminiumdruckguss, pulverbeschichtet, Lichtaustritt direkt, Kabellänge 1320mm, inkl. Erdspieß, IP65, AC-LED,

Surface-mounted spotlight, die-cast aluminium, powder-coated, direct light emission, cable length 1320mm, incl. ground spike, IP65, AC LED,



ART. NR./CODE	LEISTUNG/POWER	V AC	LUMEN	CRI>	KELVIN	Ø x B x H/Ø x W x H	FARBE/COLOUR	REFL.	CHF
472-0250480403011	SYS 4W	230	255	80	3000	54 x 80 x 96	anthracite	36°	190,80



NEW

FORIS F

Erdspießleuchte, Aluminium, neu mit CCT Chip, Ausstrahlwinkel 55° oder 35°, 2700K oder 3000K über DIP-Switch einstellbar

Ground spike luminaire, aluminium, new with CCT chip, beam angle 55° or 35°, 2700K or 3000K adjustable via dipswitch



ART. NR./CODE	LEISTUNG/POWER	V AC	LUMEN	CRI>	KELVIN	Ø x L	FARBE/COLOUR	REFL.	CHF
333-00033	SYS 11W	230	900/970	90	2700/3000	100 x 138	anthracite	60°	321,60





REFLEKTOR/REFLECTOR

ART. NR./CODE	FARBE/COLOUR	REFL.	CHF
333-A00030	■ silver	35°	22,80
333-A00031	■ silver	55°	22,80



ENDBLENDUNGSRING/SHUTTER RING

ART. NR./CODE	FARBE/COLOUR	CHF
341-7000	■ anthracite	58,80



FORIS BEAM

ART. NR./CODE	FARBE/COLOUR	CHF
333-A00032	■ anthracite	18,00





Fluter, Aluminiumdruckguss, pulverbeschichtet, symmetrische COB-Optik, schwenkbar 90°, 90°, gehärtetes Schutzglas mit 4mm Dicke, IP66, inkl. Konverter

Floodlight, die-cast aluminium, powder-coated, symmetrical COB optics, swivelling 90°, 90°, tempered safety glass with 4mm thick, IP66, incl. converter

MICRO RODIO SYMMETRISCH/MICRO RODIO SYMMETRIC



ART. NR./CODE	LEISTUNG/POWER	LUMEN	CRI>	KELVIN	B x H x T/W x H x D	FARBE/COLOUR	CHF
125-41486039	SYS 29W	2309	90	3000	145 x 227 x 45	grey	170,28
125-41486239	SYS 29W	2309	90	3000	145 x 227 x 45	anthracite	170,28
125-41486000	SYS 29W	2483	90	4000	145 x 227 x 45	grey	170,28
125-41486200	SYS 29W	2483	90	4000	145 x 227 x 45	anthracite	170,28
125-41486539	SYS 38W	2811	90	3000	145 x 227 x 45	grey	160,08
125-41486739	SYS 38W	2811	90	3000	145 x 227 x 45	anthracite	160,08
125-41486500	SYS 38W	3023	90	4000	145 x 227 x 45	grey	160,08
125-41486700	SYS 38W	3023	90	4000	145 x 227 x 45	anthracite	160,08



Fluter, Aluminiumdruckguss, pulverbeschichtet, symmetrische oder asymmetrische COB-Optik, gehärtetes Schutzglas mit 4mm Dicke, IP66, inkl. Konverter

Floodlight, die-cast aluminium, powder-coated aluminium, symmetrical or asymmetrical COB optics, tempered safety glass with 4mm thickness, IP66, incl. converter

MICRO RODIO L SYMMETRISCH/MICRO RODIO L SYMMETRIC



ART. NR./CODE	LEISTUNG/POWER	LUMEN	CRI>	KELVIN	B x H x T/W x H x D	FARBE/COLOUR	CHF
125-41489000	SYS 28W	3056	80	4000	145 x 227 x 45	grey	191,88

MICRO RODIO L ASYMMETRISCH/MICRO RODIO L ASYMMETRIC



ART. NR./CODE	LEISTUNG/POWER	LUMEN	CRI>	KELVIN	B x H x T/W x H x D	FARBE/COLOUR	CHF
125-41486739	SYS 28W	2811	80	4000	145 x 227 x 45	anthracite	160,08

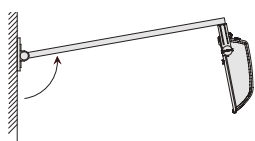

WAND AUSLEGER/WALL BRACKET

ART. NR./CODE	INFO	L/L	FARBE/COLOUR	CHF
125-99550600	Wandausleger, Stahl, schwenkbar/	800	grey	95,28
125-99550900	Wall bracket, steel, swivelling	800	anthracite	95,28



Fluter, Aluminiumdruckguss, pulverbeschichtet, symmetrische oder asymmetrische Linsen-Optik, gehärtetes Schutzglas mit 4mm Dicke, IP66, inkl. Konverter

Floodlight, die-cast aluminium, powder-coated, symmetrical or asymmetrical lens optics, tempered safety glass with 4mm thickness, IP66, incl. converter

MINI RODIO SYMMETRISCH/MINI RODIO SYMMETRIC



ART. NR./CODE	LEISTUNG/POWER	LUMEN	CRI>	KELVIN	B x H x T/W x H x D	FARBE/COLOUR	CHF
125-41494000	SYS 54W	8292	80	4000	273 x 400 x 70	grey	409,20
125-41494100	SYS 73W	10194	80	4000	273 x 400 x 70	grey	409,20

MINI RODIO ASYMMETRISCH/MINI RODIO ASYMMETRIC



ART. NR./CODE	LEISTUNG/POWER	LUMEN	CRI>	KELVIN	B x H x T/W x H x D	FARBE/COLOUR	CHF
125-41491000	SYS 54W	8456	80	4000	273 x 400 x 70	grey	409,20
125-41491100	SYS 73W	10396	80	4000	273 x 400 x 70	grey	409,20



Fluter, Aluminiumdruckguss, pulverbeschichtet, symmetrische oder asymmetrische Linsen-Optik, gehärtetes Schutzglas, IP66, inkl. Konverter

Floodlight, die-cast aluminium, powder-coated, symmetrical or asymmetrical lens optics, tempered safety glass, IP66, incl. converter

RODIO SYMMETRISCH LED/RODIO SYMMETRIC LED



ART. NR./CODE	LEISTUNG/POWER	LUMEN	CRI>	KELVIN	B x H x T/W x H x D	FARBE/COLOUR	CHF
125-41478400	SYS 53W	8627	80	4000	333 x 568 x 85	grey	712,92
125-41478500	SYS 79W	11561	80	4000	333 x 568 x 85	grey	524,88
125-41478600	SYS 118W	16881	80	4000	333 x 568 x 85	grey	786,60
125-41478700	SYS 157W	21140	80	4000	333 x 568 x 85	grey	862,92

RODIO ASYMMETRISCH LED/RODIO ASYMMETRIC LED



ART. NR./CODE	LEISTUNG/POWER	LUMEN	CRI>	KELVIN	B x H x T/W x H x D	FARBE/COLOUR	CHF
125-41475400	SYS 53W	8799	80	4000	333 x 568 x 85	grey	712,92
125-41475500	SYS 79W	11789	80	4000	333 x 568 x 85	grey	524,88
125-41475600	SYS 118W	17213	80	4000	333 x 568 x 85	grey	786,60
125-41475700	SYS 157W	21559	80	4000	333 x 568 x 85	grey	862,92

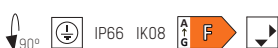

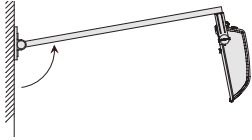

WANDAUSLEGER/WALL BRACKET

ART. NR./CODE	INFO	L/L	FARBE/COLOUR	CHF
125-99550400	Wandausleger, Stahl, schwenkbar/ wall bracket, stell, tilting	975	■ grey	223,68

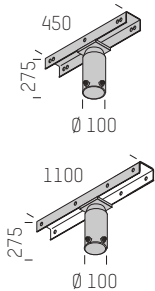

MASTAUFSAZKONSOLE/POLE MOUNTING BRACKET

ART. NR./CODE	INFO	Ø x L x H/Ø x L x H	FÜR/FOR	CHF
125-99790000	Mastaufsatzkonsole, verzinkt, für Mastzopf 60/76mm, Befestigung von 1-2 oder 2-4 Strahlern möglich, für Rodio, exkl. Fluter/ Pole mounting bracket, galvanized, for pole spigot 60/76mm, mounting of 1-2 or 2-4 spotlights possible, for Rodio, excl. floodlight	100 x 450 x 275	1 od. 2 Fluter/ 1 or 2 floodlights	252,84
125-99790100		100 x 1100 x 275	2 od. 4 Fluter/ 2 or 4 floodlights	354,60

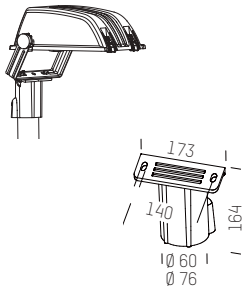

MASTAUFSAZKONSOLE/POLE MOUNTING BRACKET

ART. NR./CODE	INFO	Ø x L x H/Ø x L x H	FÜR/FOR	FARBE/COLOUR	CHF
125-99791500	Mastaufsatzkonsole, Aluminium, für Mastzopf DM= 60mm oder 76mm, für Lito, Indio und Rodio, exkl. Fluter/ Pole top bracket, aluminum, for pole spigot DM= 60mm or 76mm, for Lito, Indio and Rodio, excl. floodlight	60 x 173 x 164	1 FLUTER f. Mastzopf Ø 60/ 1 floodlight for pole spigot DM60	■ grey	71,16
125-99791600		76 x 173 x 164	1 FLUTER f. Mastzopf Ø 76/ 1 floodlight for pole spigot DM76	■ grey	67,32

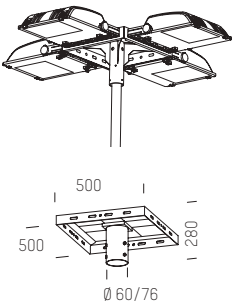

MASTAUFSAZKONSOLE/POLE MOUNTING BRACKET

ART. NR./CODE	INFO	Ø x L x H/Ø x L x H	FÜR/FOR	CHF
125-99809700	Mastaufsatzkonsole, verzinkt, für Mastzopf 60/76mm, Befestigung von 1-4 Strahlern möglich, für Rodio, exkl. Fluter/ Pole mounting bracket, galvanized, for pole spigot 60/76mm, mounting of 1-4 spotlights possible, for Rodio, excl. floodlight	500 x 500 x 280	1 - 4 Fluter für Mastzopf Ø 60/76/ 1-4 floodlights for pole spigot DM60/76	466,44



TECNICO OUTDOOR

Projet: Andels Hotel, Lodz, Polen, Foto: Molto Luce



IP68

PG KLEMMROHR/PG CLAMP TUBE



ART. NR./CODE	INFO	L x Ø	FARBE/COLOUR	CHF
102-thb391a3c	Klemmrohr mit PG Verschraubung für wasserdichte Kabelverbindungen, 3-poliger Block, Verwendung nur mit Kabel H05SS-F, für Kabel Ø 7-12 mm für max. 24A / 450V AC/ Clamping tube with PG closure for waterproof cable connections, 3-pole block, only for use with cable H05SS-F, for cable diam. 7-12mm, for max. 24A/450V AC	66 x 23	■ black	13,92



IP68

PG KLEMMROHR Y-FORM/PG CLAMP TUBE Y-FORM

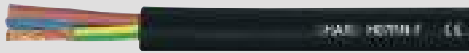
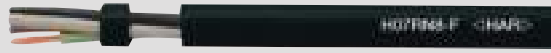

ART. NR./CODE	INFO	L x B x Ø/L x W x Ø	FARBE/COLOUR	CHF
102-thb399a3c	Klemmrohr mit PG Verschraubung für wasserdichte Kabelverbindungen, 3-poliger Block, Verwendung nur mit Kabel H05SS-F, für Kabel Ø 7-12 mm für max. 24A / 450V AC/ Clamping tube with PG closure for waterproof cable connections, 3-pole block, only for use with cable H05SS-F, for cable diam. 7-13,5mm, for max. 24A/450V AC	180 x 65,5 x 34	■ black	21,60

H07 RN-F**H07 RN8-F****Kabelverbindungen**

Mithilfe der IP68 Klemmrohre lassen sich Kabeln mühelos und dauerhaft verbinden. Es ist keine zusätzliche Bohrung im Strahler für eine weitere Kabelverschraubung zulässig.

Cable connections

Cables can be connected effortlessly and permanently using the IP68 clamping tubes. No additional holes are required in the spotlight for an additional cable gland.

**Betriebsgeräte**

Einige Bodeneinbaustrahler bestechen durch ihre minimalistische Größe. Platzsparend und aus thermischen Gründen ist das Betriebsgerät hier nicht integriert. Im Innenbereich kann das Betriebsgerät einfach im Einbaugeschütz platziert werden. Achtung auf ausreichende Wärmeableitung. Im Außenbereich bietet ein Subverteiler oder Verteilerkasten sicheren Schutz vor Witterungseinflüssen.

Control gear

Some recessed floor spotlights are characterised by their minimalist size. To save space and for thermal reasons, the control gear is not integrated here. Indoors, the control gear can simply be placed in the recessed housing. Ensure adequate heat dissipation. Outdoors, a sub-distributor or distribution box provides reliable protection from the weather.

**Reinigung der Dichtflächen**

Um eine optimale Funktion und lange Lebensdauer zu gewährleisten, müssen die Dichtungen und Dichtflächen vor dem Einbau mit Alkohol oder einem geeigneten Lösungsmittel gereinigt werden. Anschließend wird ein dünner Film Vaseline aufgetragen. Achtung, jegliche Kontamination der Dichtflächen und Dichtungen mit Sand, Staub und Fasern oder anderen Partikeln nach der Reinigung und dem Einfetten sind zu vermeiden!

Cleaning the sealing surfaces

To ensure optimum function and a long service life, the seals and sealing surfaces must be cleaned with alcohol or a suitable solvent before installation. A thin film of Vaseline should then be applied. Attention, any contamination of the sealing surfaces and seals with sand, dust and fibres or other particles after cleaning and greasing must be avoided!

Befestigungsschrauben

Diese pressen Glas oder den Befestigungsring mit der Dichtung an die Dichtfläche. Es muss darauf geachtet werden, dass die Schrauben leichtgängig sind und ein unbeschädigtes Gewinde aufweisen.

Die Befestigungsschrauben sollten jeweils gegenüberliegend in 2-3 Durchgängen mit jeweils gesteigertem Drehmoment angezogen werden.

Eventuelle Angaben des Herstellers zum Drehmoment beachten! Sind keine expliziten Angaben vorhanden, die Schrauben gefühlvoll aber handfest anziehen um die mechanische Belastbarkeit zu gewährleisten und ein Zerspringen des Glases zu vermeiden.

Fixing screws

These press the glass or the fastening ring with the seal against the sealing surface. Care must be taken to ensure that the screws run smoothly and have an undamaged thread. The fastening screws should be tightened opposite each other in 2-3 passes, each with an increased torque.

Observe any torque specifications provided by the manufacturer! If there are no explicit specifications, tighten the screws sensitively but hand-tight to ensure the mechanical load-bearing capacity and to prevent the glass from cracking.

Leuchtmittel wechseln

Beim Austausch des Leuchtmittels ist es wichtig, nach dem Wechsel das Glas und die Dichtung gründlich zu reinigen. Beim Einsetzen der Dichtung Vaseline verwenden.

Changing the bulb

When replacing the bulb, it is important to clean the glass and seal thoroughly after replacement. Use Vaseline when inserting the seal.

Dichtungen

Gewährleisten eine optimale Abdichtung gegen Feuchtigkeit und Schmutz, daher sollten defekte oder alte Dichtungen sorgfältig gegen neue Original-Ersatzdichtungen, die einige Hersteller anbieten, ausgetauscht werden.

Silikonfugen sind für Bodeneinbaustrahler nicht geeignet und können zu Schäden führen.

Seals

Ensure optimum sealing against moisture and dirt, so defective or old seals should be carefully replaced with new original replacement seals, which some manufacturers offer. Silicone joints are not suitable for recessed floor spotlights and can lead to damage.



TECNICO FLEX.light



TECNICO FLEX.light

Ab sofort sind unsere FLEX.light LEDs und Profile auch Online mit
PC, Tablet oder Mobiltelefon konfigurierbar!

From now on, our FLEX.light LEDs and profiles can also be configured online
with a PC, tablet or mobile phone!



Unsere FLEX.light LEDs sind ab sofort rollenweise innerhalb von 24h versandbereit!
Our FLEX.light LEDs are now ready to ship by the roll within 24h!



Jetzt einfach im Webshop bestellen:
Order now in the webshop:





PRODUKTÜBERSICHT

TECNICO FLEX.light



NEW

FLEX.light VANTI

Leistung/Power per M: 10W
Lichtfarbe/Light colours: 2700, 3000 oder 4000K
Info: S. 228/P. 228



NEW

FLEX.light LATO

Leistung/Power per M: 10W
Lichtfarbe/Light colours: 2700, 3000 oder 4000K
Info: S. 230/P. 230



NEW

FLEX.light COLLINA

Leistung/Power per M: 10W
Lichtfarbe/Light colours: 2700, 3000 oder 4000K
Info: S. 233/P. 233



FLEX.light PREMIUM 5W

Leistung/Power per M: 5W
Lichtfarbe/Light colours: 2500, 2700, 3000 oder 4000K
Info: S. 234/P. 234



FLEX.light PREMIUM 9W

Leistung/Power per M: 9W
Lichtfarbe/Light colours: 2500, 2700, 3000 oder 4000K
Info: S. 235/P. 235

FLEX.light PREMIUM 18W

Leistung/Power per M: 18W
Lichtfarbe/Light colours: 2500, 2700, 3000 oder 4000K
Info: S. 235/P. 235

FLEX.light PREMIUM 28W

Leistung/Power per M: 28W
Lichtfarbe/Light colours: 2500, 2700, 3000 oder 4000K
Info: S. 235/P. 235



FLEX.light BASIC 4,8W

Leistung/Power per M: 4,8W
Lichtfarbe/Light colours: 2700, 3000 oder 4000K
Info: S. 238/P. 238



FLEX.light BASIC 9,6W

Leistung/Power per M: 9,6W
Lichtfarbe/Light colours: 2700, 3000 oder 4000K
Info: S. 238/P. 238



FLEX.light BASIC 14,4W

Leistung/Power per M: 14,4W
Lichtfarbe/Light colours: 2700, 3000 oder 4000K
Info: S. 240/P. 240



FLEX.light DIM2WARM 14,4W

Leistung/Power per M: 14,4W
Lichtfarbe/Light colours: 2200, 2700 oder 3000K
Info: S. 242/P. 242



FLEX.light TUNABLE WHITE 14,4W

Leistung/Power per M: 14,4W
Lichtfarbe/Light colours: 2700 oder 6500K
Info: S. 242/P. 242



FLEX.light RGBW 18,1W

Leistung/Power per M: 18,1W
Lichtfarbe/Light colours: RGB + 3000K
Info: S. 244/P. 244

INDEX

TECNICO FLEX.light



FLEX.light 4,8W

Leistung/Power per M: 4,8W
Lichtfarbe/Light colours: 3000 oder 4000K
Info: S. 246/P. 246



FLEX.light 14,4W

Leistung/Power per M: 14,4W
Lichtfarbe/Light colours: 3000 oder 4000K
Info: S. 246/P. 246



FLEX.light TUNABLE WHITE 14,4W

Leistung/Power per M: 14,4W
Lichtfarbe/Light colours: 2700 oder 6500K
Info: S. 247/P. 247



FLEX.light RGBW 18,1W

Leistung/Power per M: 18,1W
Lichtfarbe/Light colours: RGB + 3000K
Info: S. 248/P. 248



FLEX.light BASIC 48V IP67 4,8W

Leistung/Power per M: 4,8W
Lichtfarbe/Light colours: 3000 oder 4000K
Info: S. 250/P. 250

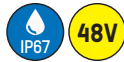

PROFILE & ZUBEHÖR/PROFILES & ACCESSOIRES



PROFILE/PROFILES

Info: S. 252/P. 252



KONVERTER/CONVERTER

Info: S. 268/P.268

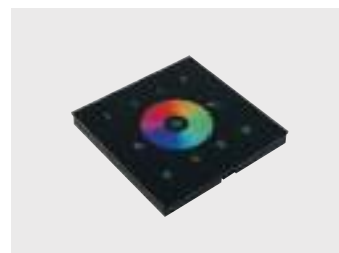

KONTROLLER/CONTROLLER

Info: S. 272/P. 272

FLEX.light VANTI, IP67, punktfreie, homogene Ausleuchtung, 3step macadam binning, CRI 90 80lm/W, Topview, vertikales Biegen möglich, passendes Zubehör, Profile, Flexprofile etc., multifunktional einsetzbar, Ausstrahlwinkel 113°

LIGHT VANTI, IP67, point-free, homogeneous illumination, 3step macadam binning, CRI 90 80lm/W, Topview, vertical bending possible, matching accessories, profiles, flex profiles etc., multifunctional use, beam angle 113°

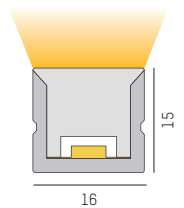
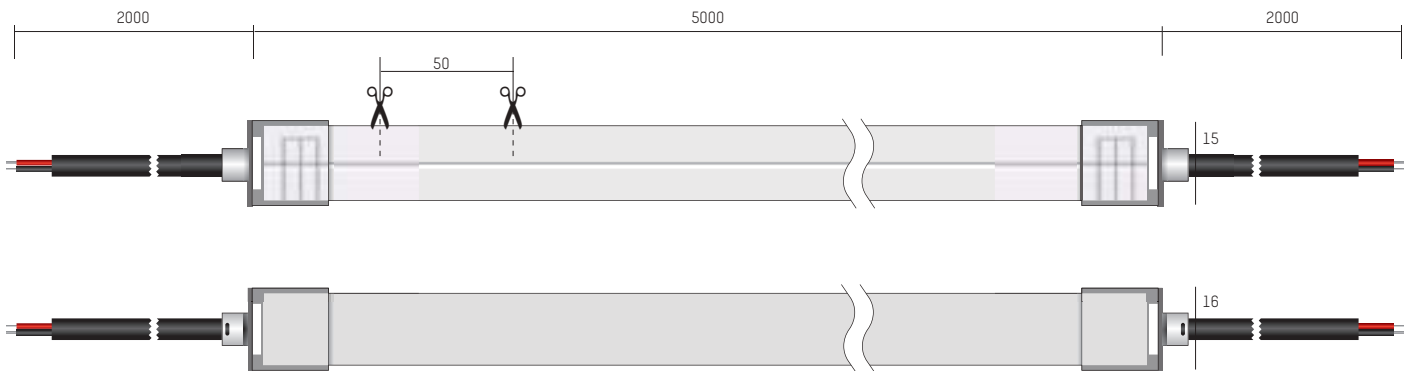

FLEX.light VANTI

ACHTUNG: maximale Länge pro Einspeisepunkt 13m LED/ **Attention:** Maximum length per feed point 13m



ART. NR./CODE	WATT LFM/WATT PER METRE	V DC	LM/M	CRI>	KELVIN	L x B x H/L x W x H	VE/PACKAGE	CHF
444-00001	LED 10W/m	24	780	90	2700	13000 x 16 x 15	Rolle/Roll	1544,40
444-00002	LED 10W/m	24	810	90	3000	13000 x 16 x 15	Rolle/Roll	1544,40
444-00003	LED 10W/m	24	910	90	4000	13000 x 16 x 15	Rolle/Roll	1544,40
444-00001konf	LED 10W/m	24	780	90	2700	1000 x 16 x 15	per Meter/per Metre	118,80
444-00002konf	LED 10W/m	24	810	90	3000	1000 x 16 x 15	per Meter/per Metre	118,80
444-00003konf	LED 10W/m	24	910	90	4000	1000 x 16 x 15	per Meter/per Metre	118,80



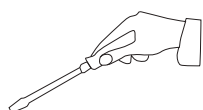

444-00003

KONFEKTIONIERUNG FLEX.light VANTI IP67/ASSEMBLY FLEX.light VANTI IP67





ART. NR./CODE	INFORMATION	CHF
283-konf	LED Band IP67 pro Zuschnitt beinhaltet: Zuschnitt, 50cm Anschlusskabel gelötet, Systemtest, ESD-Verpackung cut to size, 50cm soldered connection cable, cut seal, system test, ESD packing	25,92



PROFIL/PROFILE 

ART. NR./CODE	L x B x H/L x W x H	CHF
444-00004	2000 x 20 x 18	28,80



FLEXRAIL/FLEXRAIL 

ART. NR./CODE	L x B x H/L x W x H	CHF
444-00005	500 x 17 x 15	22,80



MONTAGECLIP SET/MOUNTING CLIP 

ART. NR./CODE	L x B x H/L x W x H	CHF
444-00006	20 x 17 x 13	22,80



EINSPEISUNG/POWER FEED 
vorne/links/front/left

ART. NR./CODE	L x B x H/L x W x H	CHF
444-00007	28 x 21 x 20	10,80



EINSPEISUNG/POWER FEED 
links/left

ART. NR./CODE	L x B x H/L x W x H	CHF
444-00008	28 x 21 x 20	10,80



EINSPEISUNG/POWER FEED 
unten/links/bottom/left

ART. NR./CODE	L x B x H/L x W x H	CHF
444-00009	28 x 21 x 20	10,80



ENDKAPPE/END CAP 
2 Stk./2 Pcs.

ART. NR./CODE	L x B x H/L x W x H	CHF
444-00010	28 x 21 x 20	8,40



EINSPEISUNG/POWER FEED 
rechts/right

ART. NR./CODE	L x B x H/L x W x H	CHF
444-00036	28 x 21 x 20	10,80



EINSPEISUNG/POWER FEED 
vorne/rechts

ART. NR./CODE	L x B x H/L x W x H	CHF
444-00038	28 x 21 x 20	10,80



EINSPEISUNG/POWER FEED 
unten/rechts/bottom/right

ART. NR./CODE	L x B x H/L x W x H	CHF
444-00040	28 x 21 x 20	10,80



FLEX.light LAT0, IP67, 3step macadam binning, CRI 90 60lm/W, Sideview-seitliches / horizontales Biegen möglich, passendes Zubehör Profile, Flexprofile etc., multifunktional einsetzbar, Ausstrahlwinkel 114°

FLEX.light LAT0, IP67, 3step macadam binning, CRI 90 60lm/W, side view / horizontal bending possible, suitable accessories profiles, flex profiles etc., multifunctional use, beam angle 114°

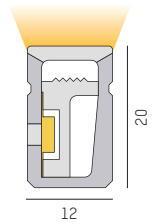
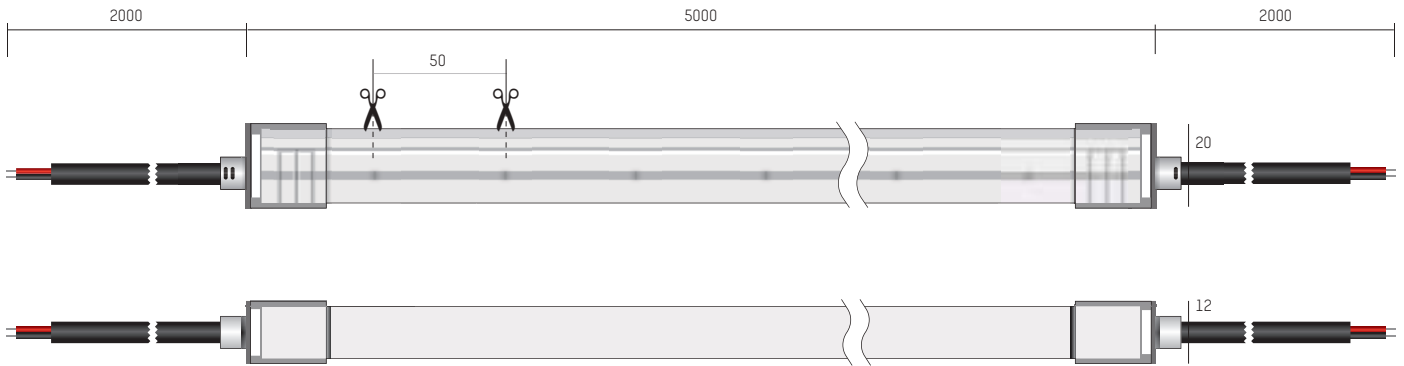

FLEX.light LAT0

ACHTUNG: maximale Länge pro Einspeisepunkt 13m LED/ **Attention:** Maximum length per feed point 13m



ART. NR./CODE	WATT LFM/WATT PER METRE	V DC	LM/M	CRI>	KELVIN	L x B x H/L x W x H	VE/PACKAGE	CHF
444-00011	LED 10W/m	24	570	90	2700	13000 x 12 x 20	Rolle/Roll	1544,40
444-00012	LED 10W/m	24	580	90	3000	13000 x 12 x 20	Rolle/Roll	1544,40
444-00013	LED 10W/m	24	630	90	4000	13000 x 12 x 20	Rolle/Roll	1544,40
444-00011konf	LED 10W/m	24	570	90	2700	1000 x 12 x 20	per Meter/per Metre	118,80
444-00012konf	LED 10W/m	24	580	90	3000	1000 x 12 x 20	per Meter/per Metre	118,80
444-00013konf	LED 10W/m	24	630	90	4000	1000 x 12 x 20	per Meter/per Metre	118,80





444-00013

KONFEKTIONIERUNG FLEX.light LAT0 IP67/ASSEMBLY FLEX.light LAT0 IP67





ART. NR./CODE	INFORMATION	CHF
283-konf	LED Band IP67 pro Zuschnitt beinhaltet: Zuschnitt, 50cm Anschlusskabel gelötet, Systemtest, ESD-Verpackung cut to size, 50cm soldered connection cable, cut seal, system test, ESD packing	25,92



PROFIL/PROFILE 

ART. NR./CODE	L x B x H/L x W x H	CHF
444-00014	2000 x 18 x 23	28,80



FLEXRAIL/FLEXRAIL 

ART. NR./CODE	L x B x H/L x W x H	CHF
444-00015	500 x 27 x 18	22,80



MONTAGECLIP SET/MOUNTING CLIP 

ART. NR./CODE	L x B x H/L x W x H	CHF
444-00016	20 x 13 x 19	22,80



EINSPEISUNG/POWER FEED
vorne/links/front/left 

ART. NR./CODE	L x B x H/L x W x H	CHF
444-00017	28 x 21 x 20	10,80



EINSPEISUNG/POWER FEED
links/left 

ART. NR./CODE	L x B x H/L x W x H	CHF
444-00018	27 x 17 x 25	10,80



EINSPEISUNG/POWER FEED
unten/links/bottom/left 

ART. NR./CODE	L x B x H/L x W x H	CHF
444-00019	27 x 17 x 25	10,80



ENDKAPPE/END CAP
2 Stk./2 Pcs. 

ART. NR./CODE	L x B x H/L x W x H	CHF
444-00020	27 x 17 x 25	8,40



EINSPEISUNG/POWER FEED
rechts/right 

ART. NR./CODE	L x B x H/L x W x H	CHF
444-00037	27 x 17 x 25	10,80



EINSPEISUNG/POWER FEED
vorne/rechts 

ART. NR./CODE	L x B x H/L x W x H	CHF
444-00041	27 x 17 x 25	10,80



EINSPEISUNG/POWER FEED
unten/rechts/bottom/right 

ART. NR./CODE	L x B x H/L x W x H	CHF
444-00041	27 x 17 x 25	10,80



FLEX.light COLLINA, IP65, punktfreie, homogene Ausleuchtung, sehr flach und elegant, UV und Korrosionsbeständig, 3step macadam binning, CRI 90, Ausstrahlwinkel 130°

FLEX.light COLLINA, IP65, point-free, homogeneous illumination, very flat and elegant, UV and corrosion-resistant, 3step macadam binning, CRI90, beam angle 130°

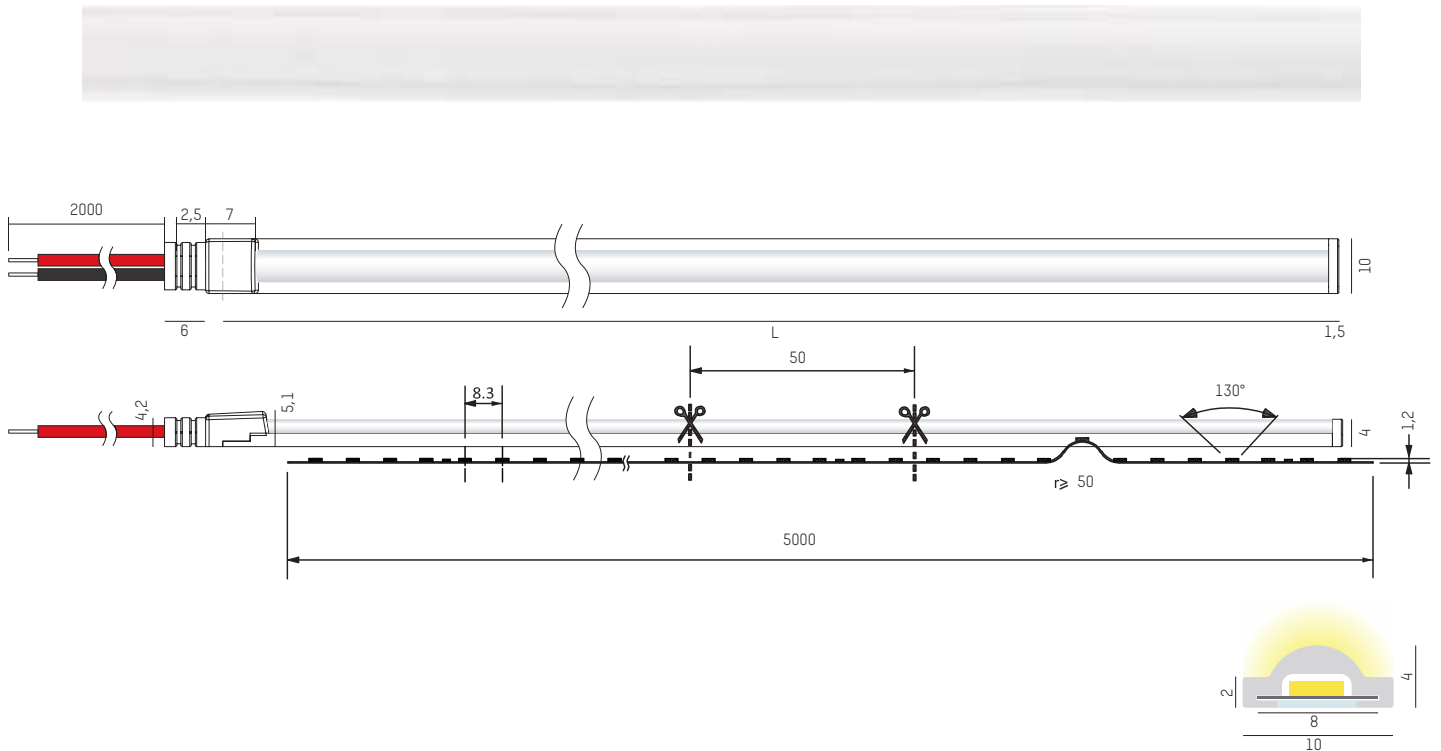

FLEX.light COLLINA

ACHTUNG: maximale Länge pro Einspeisepunkt 5m LED/ Attention: Maximum length per feed point 5m



ART. NR./CODE	WATT LFM/WATT PER METRE	V DC	LM/M	CRI>	KELVIN	L x B x H/L x W x H	VE/PACKAGE	CHF
444-00030	LED 10W/m	24	760	90	2700	5000 x 10 x 4	Rolle/Roll	234,00
444-00031	LED 10W/m	24	790	90	3000	5000 x 10 x 4	Rolle/Roll	234,00
444-00032	LED 10W/m	24	840	90	4000	5000 x 10 x 4	Rolle/Roll	234,00
444-00030konf	LED 10W/m	24	760	90	2700	1000 x 10 x 4	per Meter/per Metre	46,80
444-00031konf	LED 10W/m	24	790	90	3000	1000 x 10 x 4	per Meter/per Metre	46,80
444-00032konf	LED 10W/m	24	840	90	4000	1000 x 10 x 4	per Meter/per Metre	46,80

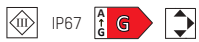

MONTAGECLIP/MOUNTING CLIP
weiss/white



ART. NR./CODE	L x B x H/L x W x H	CHF
444-00033	14 x 12 x 5	3,60

ENDKAPPE MIT EINSPEISUNG/ ENDPIECE WITH POWERFEED

mit 20cm Kabel, weiss/with 20cm cable, white



ART. NR./CODE	L x B x H/L x W x H	CHF
444-00034	12 x 6 x 16	3,60

ENDKAPPE/ENDPIECE



ART. NR./CODE	L x B x H/L x W x H	CHF
444-00035	12 x 6 x 9	2,40

KONFEKTIONIERUNG FLEX.light COLLINA IP67/ASSEMBLY FLEX.light COLLINA IP67



ART. NR./CODE	INFORMATION	CHF
283-konf	LED Band IP67 pro Zuschnitt beinhaltet: Zuschnitt, 50cm Anschlusskabel gelötet, Systemtest, ESD-Verpackung cut to size, 50cm soldered connection cable, cut seal, system test, ESD packing	25,92



Flexibles PREMIUM LED Stripe, IP65 mittels Plasmabeschichtung, Meterware, 120 LEDs/M, 5W/M, 3step macadam binning, trennbar alle 5cm, Befestigung durch doppelseitiges 3M Klebeband, exkl. Konverter, Montage auf wärmeleitendem Material Voraussetzung! Bitte kalkulieren Sie pro Zuschnitt 1x Art.-Nr.: 283-konf zusätzlich

Flexible PREMIUM LED stripe, IP65, by plasma coating, 120 LEDs/m, separable each 5 cm, fixing with double-sided adhesive tape 3M, without driver, in order to guarantee a long service life and perfect functioning of the LED stripes, they must be mounted on heat conducting material! Please calculate per cut 1x code 283-konf additionally.

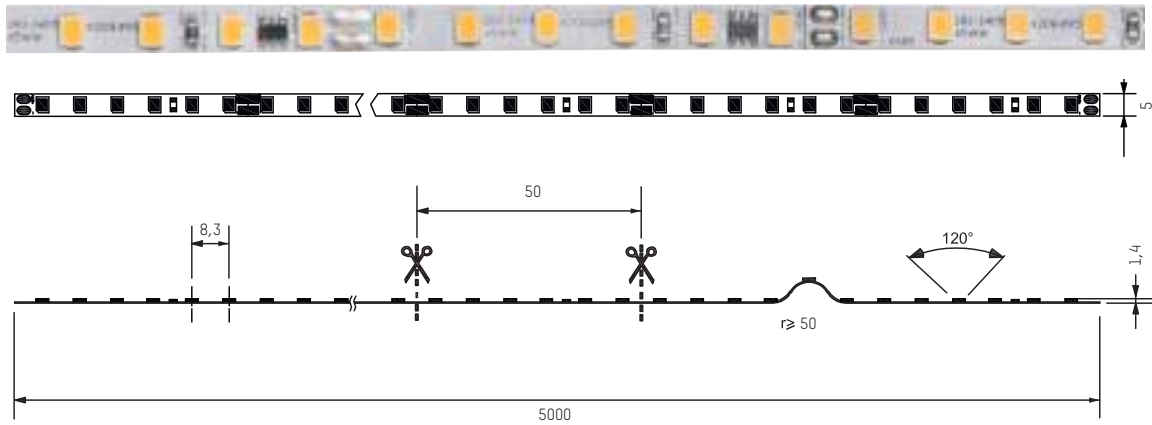

FLEX.light PREMIUM 5W

ACHTUNG: maximale Länge pro Einspeisepunkt 5m LED/ Attention: Maximum length per feed point 5m



ART. NR./CODE	LEISTUNG/POWER	V DC	LM/M	CRI>	KELVIN	L x B x H/L x W x H	VE/PACKAGE	CHF
283-240565uuww	LED 5W/m	24	440	90	2500	10000 x 5 x 1,4	Rolle/Roll	580,80
283-240565uwvw	LED 5W/m	24	470	90	2700	10000 x 5 x 1,4	Rolle/Roll	580,80
283-240565ww	LED 5W/m	24	520	90	3000	10000 x 5 x 1,4	Rolle/Roll	580,80
283-240565nw	LED 5W/m	24	580	90	4000	10000 x 5 x 1,4	Rolle/Roll	580,80
283-240565uuwwkonf	LED 5W/m	24	440	90	2500	lt. order x 5 x 1,4	per Meter/per Metre	58,44
283-240565uwvwkonf	LED 5W/m	24	470	90	2700	lt. order x 5 x 1,4	per Meter/per Metre	58,44
283-240565wwkonf	LED 5W/m	24	520	90	3000	lt. order x 5 x 1,4	per Meter/per Metre	58,44
283-240565nwwkonf	LED 5W/m	24	580	90	4000	lt. order x 5 x 1,4	per Meter/per Metre	58,44



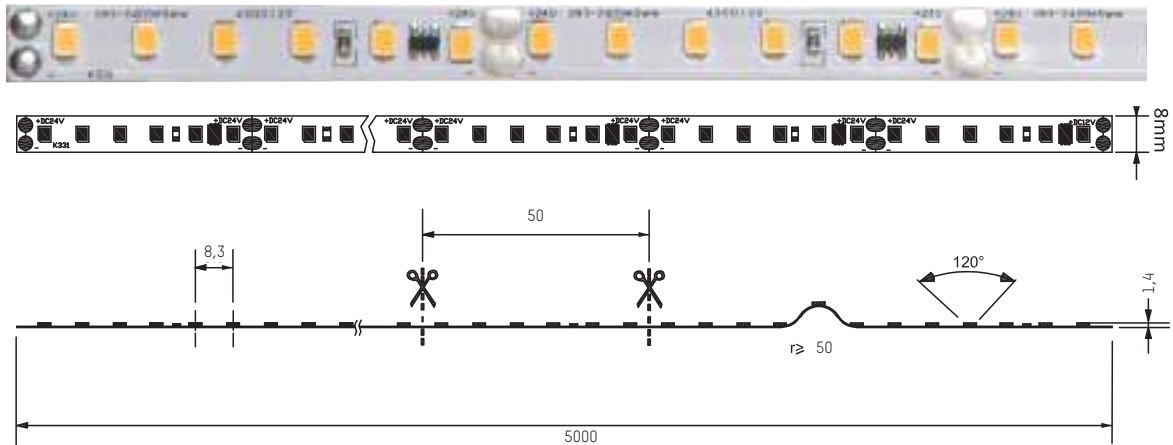

FLEX.light PREMIUM 9W

ACHTUNG: maximale Länge pro Einspeisepunkt 10m LED/ Attention: Maximum length per feed point 10m



ART. NR./CODE	LEISTUNG/POWER	V DC	LM/M	CRI>	KELVIN	L x B x H/L x W x H	VE/PACKAGE	CHF
283-240965uww	LED 9W/m	24	950	90	2500	30000 x 8 x 1,4	Rolle/Roll	1827,36
283-240965uww	LED 9W/m	24	1054	90	2700	30000 x 8 x 1,4	Rolle/Roll	1827,36
283-240965ww	LED 9W/m	24	1058	90	3000	30000 x 8 x 1,4	Rolle/Roll	1827,36
283-240965nw	LED 9W/m	24	1134	90	4000	30000 x 8 x 1,4	Rolle/Roll	1827,36
283-240965uwwkonf	LED 9W/m	24	950	90	2500	lt. order x 8 x 1,4	per Meter/per Metre	60,96
283-240965uwwkonf	LED 9W/m	24	1054	90	2700	lt. order x 8 x 1,4	per Meter/per Metre	60,96
283-240965wwkonf	LED 9W/m	24	1058	90	3000	lt. order x 8 x 1,4	per Meter/per Metre	60,96
283-240965nwkonf	LED 9W/m	24	1134	90	4000	lt. order x 8 x 1,4	per Meter/per Metre	60,96

FLEX.light PREMIUM 18W

ACHTUNG: maximale Länge pro Einspeisepunkt 8m LED/ Attention: Maximum length per feed point 8m



ART. NR./CODE	LEISTUNG/POWER	V DC	LM/M	CRI>	KELVIN	L x B x H/L x W x H	VE/PACKAGE	CHF
283-241865uww	LED 18W/m	24	1755	90	2500	30000 x 8 x 1,4	Rolle/Roll	1906,20
283-241865uww	LED 18W/m	24	1934	90	2700	30000 x 8 x 1,4	Rolle/Roll	1906,20
283-241865ww	LED 18W/m	24	1980	90	3000	30000 x 8 x 1,4	Rolle/Roll	1906,20
283-241865nw	LED 18W/m	24	2148	90	4000	30000 x 8 x 1,4	Rolle/Roll	1906,20
283-241865uwwkonf	LED 18W/m	24	1755	90	2500	lt. order x 8 x 1,4	per Meter/per Metre	63,60
283-241865uwwkonf	LED 18W/m	24	1934	90	2700	lt. order x 8 x 1,4	per Meter/per Metre	63,60
283-241865wwkonf	LED 18W/m	24	1980	90	3000	lt. order x 8 x 1,4	per Meter/per Metre	63,60
283-241865nwkonf	LED 18W/m	24	2148	90	4000	lt. order x 8 x 1,4	per Meter/per Metre	63,60

FLEX.light PREMIUM 28W

ACHTUNG: maximale Länge pro Einspeisepunkt 4m LED/ Attention: Maximum length per feed point 4m



ART. NR./CODE	LEISTUNG/POWER	V DC	LM/M	CRI>	KELVIN	L x B x H/L x W x H	VE/PACKAGE	CHF
283-242865uww	LED 28W/m	24	2500	90	2500	30000 x 8 x 1,4	Rolle/Roll	2075,16
283-242865uww	LED 28W/m	24	2890	90	2700	30000 x 8 x 1,4	Rolle/Roll	2075,16
283-242865ww	LED 28W/m	24	2922	90	3000	30000 x 8 x 1,4	Rolle/Roll	2075,16
283-242865nw	LED 28W/m	24	3191	90	4000	30000 x 8 x 1,4	Rolle/Roll	2075,16
283-242865uwwkonf	LED 28W/m	24	2500	90	2500	lt. order x 8 x 1,4	per Meter/per Metre	68,64
283-242865uwwkonf	LED 28W/m	24	2890	90	2700	lt. order x 8 x 1,4	per Meter/per Metre	68,64
283-242865wwkonf	LED 28W/m	24	2922	90	3000	lt. order x 8 x 1,4	per Meter/per Metre	68,64
283-242865nwkonf	LED 28W/m	24	3191	90	4000	lt. order x 8 x 1,4	per Meter/per Metre	68,64



IP65



KONFEKTIONIERUNG FLEX.light PREMIUM/ASSEMBLY FLEX.light PREMIUM



ART. NR./CODE	INFO	CHF
283-konf	LED Band IP65 pro Zuschnitt beinhaltet: Zuschnitt, 50cm Anschlusskabel gelötet, Anschnittversiegelung, Systemtest, ESD-Verpackung/ cut to size, 50cm soldered connection cable, cut seal, system test, ESD packing	25,92





TECNICO FLEX.light

Flexibles BASIC LED Stripe, Rolle 5000mm, 300 SMD3528 LEDs, 60 LEDs/M, 4,8, 9,6 und 14,4W/M 3step macadam binning, trennbar alle 6 LEDs (ca. 10cm), Befestigung durch doppel-seitiges 3M Klebeband, exkl. Konverter.

ACHTUNG: Keine Beständigkeit gegen chemische Substanzen oder Dämpfe (z.B. Chlor u. dgl.); Um eine lange Lebensdauer und einwandfreie Funktion der LED-Stripes zu garantieren, ist eine Montage auf wärmeleitendem Material Voraussetzung! Bitte kalkulieren Sie pro Zuschnitt 1 x Art.-Nr.: 746-konf zusätzlich

Flexible BASIC LED stripe, roll 5000mm, 300 SMD3528 LEDs, 60 LEDs/m, 4,8, 9,6 and 14,4W/m, separable each 6 LEDs (ca. 10cm), fixing with double-sided adhesive tape 3M, without driver, please calculate per cut 1x code: 746-konf additionally.

Attention: No resistance to chemical substances or vapours (e.g. chlorine and similar).

In order to guarantee a long service life and perfect functioning of the LED stripes, they must be mounted on heat conducting material!

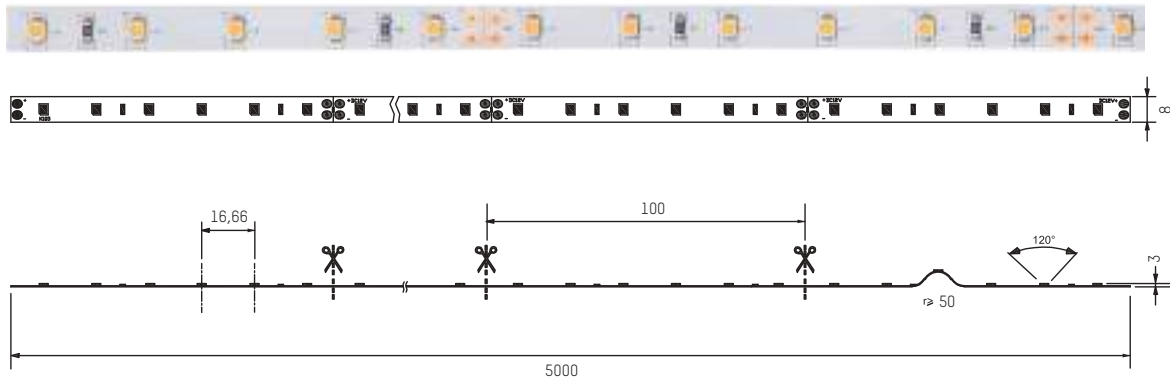

FLEX.light BASIC 4,8W

ACHTUNG: maximale Länge pro Einspeisepunkt 10m LED/ **Attention:** Maximum length per feed point 10m



ART. NR./CODE	LEISTUNG/POWER	V DC	LM/M	CRI>	KELVIN	L x B x H/L x W x H	VE/PACKAGE	CHF
746-1242420uw	LED 4,8W/m	24	400	80	2700	5000 x 8 x 3	Rolle/Roll	53,40
746-1242420ww	LED 4,8W/m	24	440	80	3000	5000 x 8 x 3	Rolle/Roll	53,40
746-1242420nw	LED 4,8W/m	24	473	80	4000	5000 x 8 x 3	Rolle/Roll	53,40
746-1242420uwkonf	LED 4,8W/m	24	400	80	2700	lt. order x 8 x 3	per Meter/per Metre	10,20
746-1242420wwkonf	LED 4,8W/m	24	440	80	3000	lt. order x 8 x 3	per Meter/per Metre	10,20
746-1242420nwkonf	LED 4,8W/m	24	473	80	4000	lt. order x 8 x 3	per Meter/per Metre	10,20

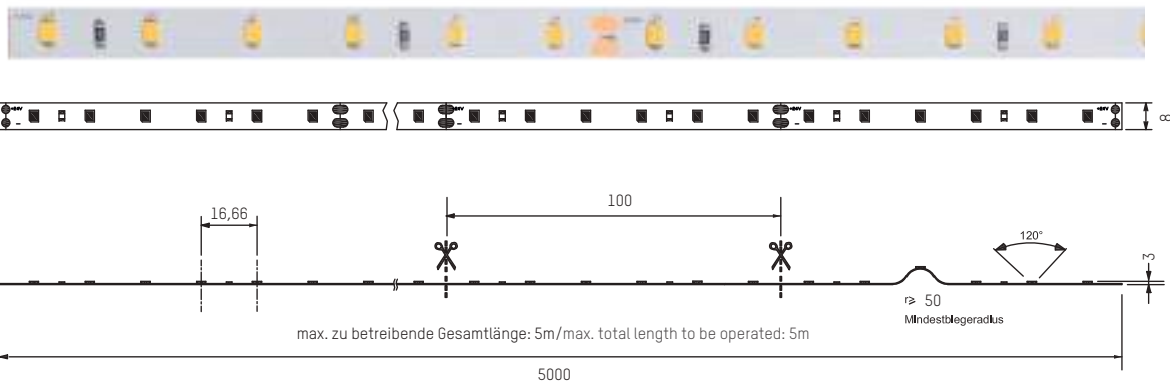

FLEX.light BASIC 9,6W

ACHTUNG: maximale Länge pro Einspeisepunkt 7m LED/ **Attention:** Maximum length per feed point 7m



ART. NR./CODE	LEISTUNG/POWER	V DC	LM/M	CRI>	KELVIN	L x B x H/L x W x H	VE/PACKAGE	CHF
746-1244820uw	LED 9,6W/m	24	900	80	2700	5000 x 8 x 3	Rolle/Roll	54,60
746-1244820ww	LED 9,6W/m	24	983	80	3000	5000 x 8 x 3	Rolle/Roll	54,60
746-1244820nw	LED 9,6W/m	24	1006	80	4000	5000 x 8 x 3	Rolle/Roll	54,60
746-1244820uwkonf	LED 9,6W/m	24	900	80	2700	lt. order x 8 x 3	per Meter/per Metre	11,40
746-1244820wwkonf	LED 9,6W/m	24	983	80	3000	lt. order x 8 x 3	per Meter/per Metre	11,40
746-1244820nwkonf	LED 9,6W/m	24	1006	80	4000	lt. order x 8 x 3	per Meter/per Metre	11,40



SCHNELLEINSPEISER/FAST POWER FEED

ART. NR./CODE	INFO	CHF
746-fc1220w	inkl. 200mm Kabel/ incl. 200mm cable	3,84



SCHNELLVERBINDER/FAST CONNECTOR

ART. NR./CODE	CHF
746-lc1220w	1,92



LINEARVERBINDER/LINEAR CONNECTOR

ART. NR./CODE	INFO	CHF
746-lcf1220w	inkl. 100mm Kabel/ incl. 100mm cable	3,84



KONFEKTIONIERUNG FLEX.light BASIC/ASSEMBLY FLEX.light BASIC

ART. NR./CODE	INFO	CHF
746-konfip20	LED Band IP20 pro Zuschnitt beinhaltet: Zuschnitt, 50cm Anschlusskabel gelötet, Systemtest, ESD-Verpackung/ cut to size, 50cm soldered connection cable, cut seal, system test, ESD packing	25,92



Flexibles BASIC LED Stripe, Rolle 5000mm, 300 SMD3528 LEDs, 60 LEDs/M, 4,8, 9,6 und 14,4W/M, 3step macadam binning, trennbar alle 6 LEDs (ca. 10cm), Befestigung durch doppel-seitiges 3M Klebeband, exkl. Konverter.

ACHTUNG: Keine Beständigkeit gegen chemische Substanzen oder Dämpfe (z.B. Chlor u. dgl.); Um eine lange Lebensdauer und einwandfreie Funktion der LED-Stripes zu garantieren, ist eine Montage auf wärmeleitendem Material Voraussetzung! Bitte kalkulieren Sie pro Zuschnitt 1x Art.-Nr.: 746-konf zusätzlich

Flexible BASIC LED stripe, roll 5000mm, 300 SMD3528 LEDs, 60 LEDs/m, 4,8, 9,6 and 14,4W/m, separable each 6 LEDs (ca. 10cm), fixing with double-sided adhesive tape 3M, without driver, please calculate per cut 1x code: 746-konf additionally.

Attention: No resistance to chemical substances or vapours (e.g. chlorine and similar).

In order to guarantee a long service life and perfect functioning of the LED stripes, they must be mounted on heat conducting material!

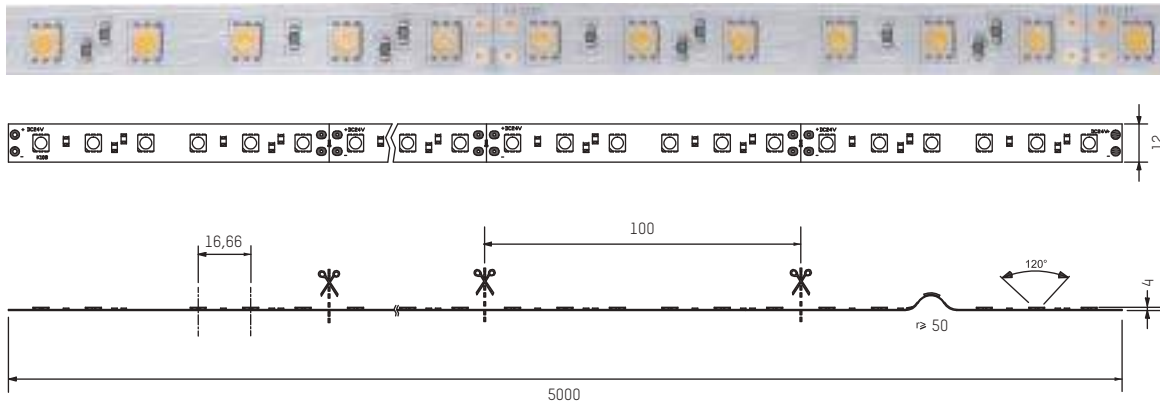

FLEX.light BASIC 14,4W

ACHTUNG: maximale Länge pro Einspeisepunkt 5m LED/ **Attention:** Maximum length per feed point 5m



ART. NR./CODE	LEISTUNG/POWER	V DC	LM/M	CRI>	KELVIN	L x B x H/L x W x H	VE/PACKAGE	CHF
746-1247220uw	LED 14,4W/m	24	1280	80	2700	5000 x 12 x 4	Rolle/Roll	102,96
746-1247220ww	LED 14,4W/m	24	1395	80	3000	5000 x 12 x 4	Rolle/Roll	102,96
746-1247220nw	LED 14,4W/m	24	1475	80	4000	5000 x 12 x 4	Rolle/Roll	102,96
746-1247220uwkonf	LED 14,4W/m	24	1280	80	2700	lt. order x 12 x 4	per Meter/per Metre	20,28
746-1247220wwkonf	LED 14,4W/m	24	1395	80	3000	lt. order x 12 x 4	per Meter/per Metre	20,28
746-1247220nwkonf	LED 14,4W/m	24	1475	80	4000	lt. order x 12 x 4	per Meter/per Metre	20,28



SCHNELLEINSPEISER/FAST POWER FEED

ART. NR./CODE	INFO	CHF
746-fc2420w	inkl. 200mm Kabel/ incl. 200mm cable	2,52



SCHNELLVERBINDER/FAST CONNECTOR

ART. NR./CODE	CHF
746-lc2420w	1,92



LINEARVERBINDER/LINEAR CONNECTOR

ART. NR./CODE	INFO	CHF
746-lcf2420w	inkl. 100mm Kabel/ incl. 100mm cable	4,44



KONFEKTIONIERUNG FLEX.light BASIC/ASSEMBLY FLEX.light BASIC

ART. NR./CODE	INFO	CHF
746-konfip20	LED Band IP20 pro Zuschnitt beinhaltet: Zuschnitt, 50cm Anschlusskabel gelötet, Systemtest, ESD-Verpackung/ cut to size, 50cm soldered connection cable, cut seal, system test, ESD packing	25,92



TECNICO FLEX.light

Flexibles BASIC LED Stripe, Rolle 5000mm, 120 SMD2835 LEDs pro Meter 14,4W/M, 3step macadam binning, trennbar alle 10cm, Befestigung durch doppelseitiges 3M Klebeband, exkl. Konverter

ACHTUNG: Keine Beständigkeit gegen chemische Substanzen oder Dämpfe (z.B. Chlor u. dgl.); Um eine lange Lebensdauer und einwandfreie Funktion der LED-Stripes zu garantieren, ist eine Montage auf wärmeleitendem Material Voraussetzung!

Flexible DIM2WARM stripe 14,4W per meter, roll 5000mm, 120 SMD2835 LEDs per meter, separable each 10cm, fixing with double-sided adhesive tape 3M, without driver

Attention: No resistance to chemical substances or vapours (e.g. chlorine and similar).

In order to guarantee a long service life and perfect functioning of the LED stripes, they must be mounted on heat conducting material!

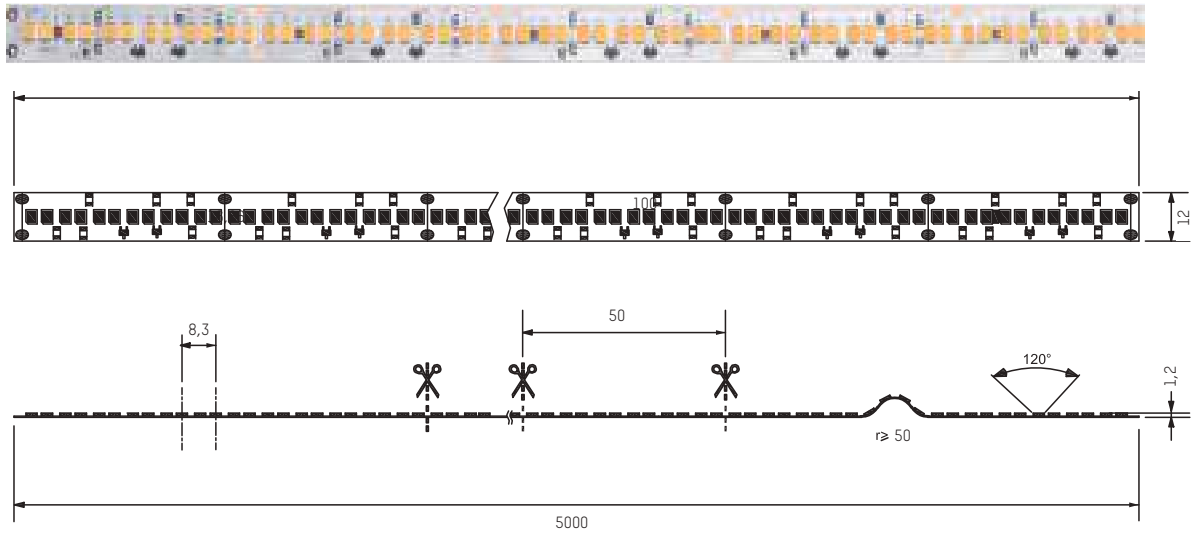

FLEX.light DIM2WARM 14,4W

ACHTUNG: maximale Länge pro Einspeisepunkt 5m LED/ **Attention:** Maximum length per feed point 5m

ART. NR./CODE	LEISTUNG/POWER	V DC	LM/M	CRI>	KELVIN	L x B x H/L x W x H	VE/PACKAGE	CHF
746-247220wd2w	LED 14,4W/m	24	1330	80	2200/3000	5000 x 12 x 1,4	5m Rolle/5m Roll	261,84
746-247220ud2w	LED 14,4W/m	24	1270	80	2200/2700	5000 x 12 x 1,4	5m Rolle/5m Roll	261,84

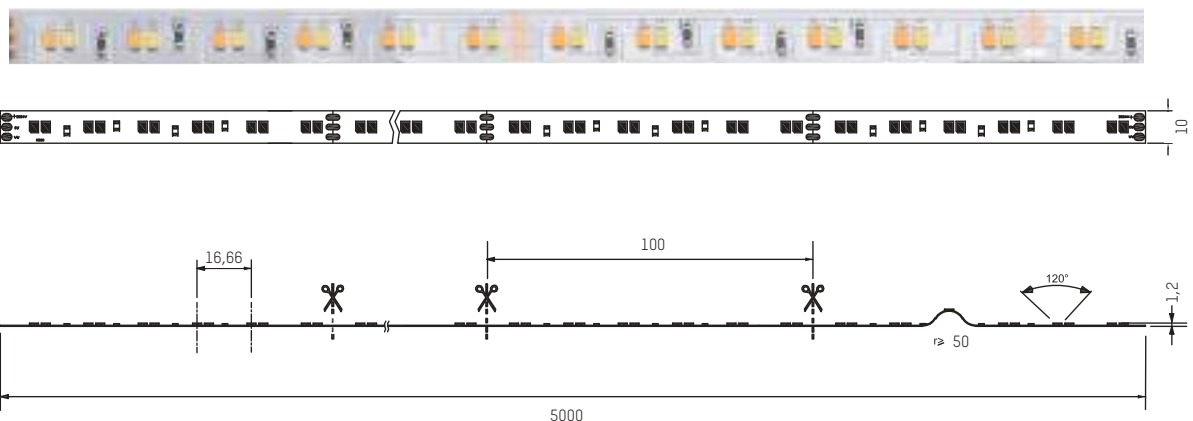

FLEX.light TUNABLE WHITE 14,4W

ACHTUNG: maximale Länge pro Einspeisepunkt 5m LED/ **Attention:** Maximum length per feed point 5m

ART. NR./CODE	LEISTUNG/POWER	V DC	LM/M	CRI>	KELVIN	L x B x H/L x W x H	VE/PACKAGE	CHF
746-241420tw	LED 14,4W/m	24	2700-736 6500-782	80	2700/6500	5000 x 10 x 1,4	5m Rolle/5m Roll	106,80





Projekt: Hotel Almlust, Flachau, Österreich, Foto: Hotel Almlust



Projekt: Private Residence, Österreich, Foto: Molto Luce

TECNICO FLEX.light

Flexibles BASIC LED Stripe RGB-W, Rolle 5000mm, 480 SMD LEDs, 48 SMD RGB 5050 LEDs/Meter, 48 SMD 2835 LEDs/M, 18,1W/M, trennbar alle 12 LEDs (ca. 10cm) Befestigung durch doppelseitiges 3M Klebeband, exkl. Konverter

ACHTUNG: Keine Beständigkeit gegen chemische Substanzen oder Dämpfe (z.B. Chlor u. dgl.); Um eine lange Lebensdauer und einwandfreie Funktion der LED-Stripes zu garantieren, ist eine Montage auf wärmeleitendem Material Voraussetzung!

Flexible RGB-W stripe 18,1W per meter, roll 5000mm, 480 SMD LEDs, 48 SMD RGB 5050 LEDs/m, separable each 10cm, fixing with double-sided adhesive tape 3M, without driver

Attention: No resistance to chemical substances or vapours (e.g. chlorine and similar).

In order to guarantee a long service life and perfect functioning of the LED stripes, they must be mounted on heat conducting material!

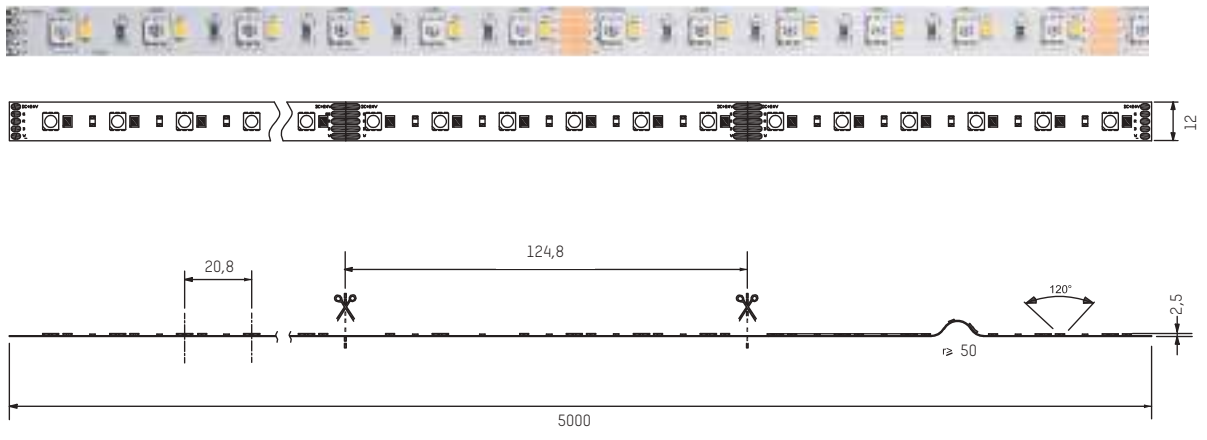

FLEX.light RGBW 18,1W

ACHTUNG: maximale Länge pro Einspeisepunkt 5m LED/ **Attention:** Maximum length per feed point 5m



ART. NR./CODE	LEISTUNG/POWER	V DC	LM/M	CRI>	KELVIN	L x B x H/L x W x H	VE/PACKAGE	CHF
746-1249120rgbw	LED 18,1W/m	24	101 red 279 green 65 blue 428 white	---	RGB+ 3000	5000 x 12 x 2,5	5m Rolle/5m Roll	134,76





Flexibles BASIC LED Stripe, Rolle 5000mm, 300 SMD3528 LEDs, 60 LEDs/M, 4,8W und 14,4W/M, trennbar alle 6 LEDs (ca. 10cm), Band muss nach Trennung versiegelt werden!, Befestigung durch doppelseitiges 3M Klebeband, inkl. DC Stecker und 2 Buchsen, exkl. Konverter

ACHTUNG: Keine Beständigkeit gegen chemische Substanzen oder Dämpfe (z.B. Chlor u. dgl.); Um eine lange Lebensdauer und einwandfreie Funktion der LED-Stripes zu garantieren, ist eine Montage auf wärmeleitendem Material Voraussetzung!

Flexible BASIC LED IP67 stripe, roll 5000mm, 300 SMD5060 LEDs, 60 LEDs/m, 4,8W and 14,4W/m, separable each 6 LEDs (ca. 10cm), Stripe must be sealed after separation! fixing with double-sided adhesive tape 3M, with DC plug and 2 sockets, without driver

Attention: No resistance to chemical substances or vapours (e.g. chlorine and similar). In order to guarantee a long service life and perfect functioning of the LED stripes, they must be mounted on heat conducting material!

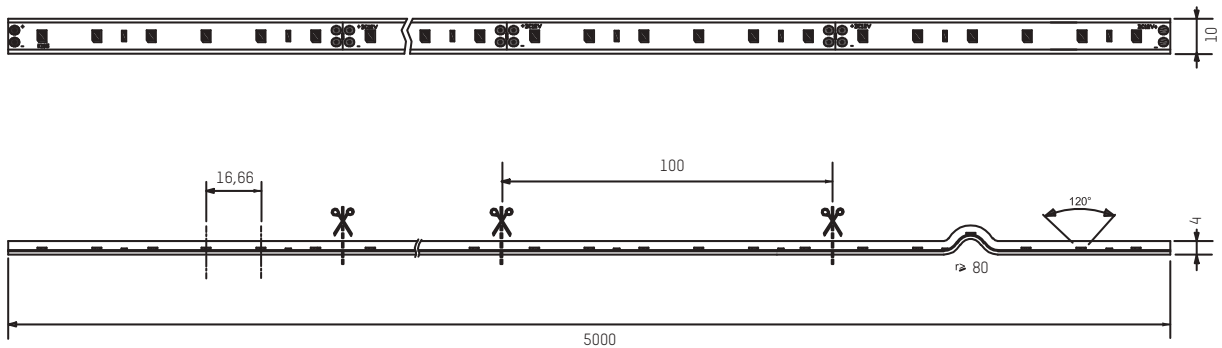

FLEX.light 4,8W

ACHTUNG: maximale Länge pro Einspeisepunkt 5m LED/ **Attention:** Maximum length per feed point 5m



ART. NR./CODE	LEISTUNG/POWER	V DC	LM/M	CRI>	KELVIN	L x B x H/L x W x H	VE/PACKAGE	CHF
746-1242467ww	LED 4,8W/m	24	350	80	3000	5000 x 10 x 4	5m Rolle/5m Roll	91,44
746-1242467nw	LED 4,8W/m	24	370	80	4000	5000 x 10 x 4	5m Rolle/5m Roll	91,44

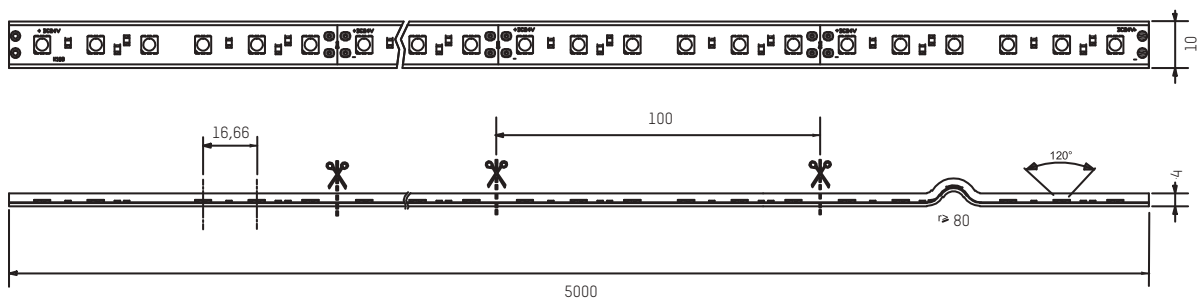

FLEX.light 14,4W

ACHTUNG: maximale Länge pro Einspeisepunkt 5m LED/ **Attention:** Maximum length per feed point 5m



ART. NR./CODE	LEISTUNG/POWER	V DC	LM/M	CRI>	KELVIN	L x B x H/L x W x H	VE/PACKAGE	CHF
746-1247267ww	LED 14,4W/m	24	1090	80	3000	5000 x 14,2 x 4	5m Rolle/5m Roll	146,16
746-1247267nw	LED 14,4W/m	24	1130	80	4000	5000 x 14,2 x 4	5m Rolle/5m Roll	146,16



SILIKONENDKAPPE/SILICON END CAP

ART. NR./CODE	CHF
746-1001	1,32



SCHRUMPFSCHLAUCH/SHRINK TUBE

ART. NR./CODE	CHF
746-1004	0,60



EINSPEISUNGSABDECKUNG/FEED IN COVER

ART. NR./CODE	CHF
746-1101	1,32



DC-STECKER/DC PLUG

ART. NR./CODE	INFO	CHF
746-1100	inkl. 130mm Kabel/ incl. 130mm cable	2,52



DC-BUCHSE/DC SOCKET

ART. NR./CODE	INFO	CHF
746-1200	inkl. 130mm Kabel/ incl. 130mm cable	2,52

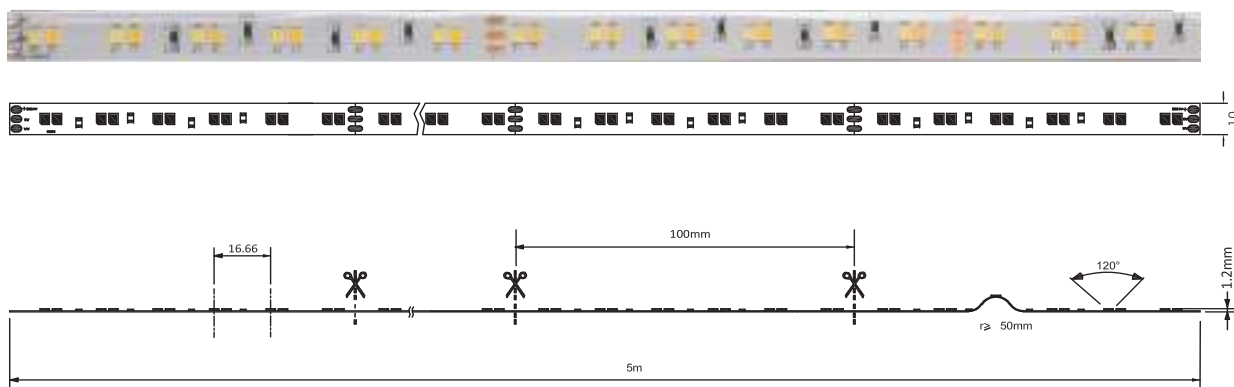

FLEX.light TUNABLE WHITE 14,4W

ACHTUNG: maximale Länge pro Einspeisepunkt 5m LED/
Attention: Maximum length per feed point 5m



ART. NR./CODE	LEISTUNG/POWER	V DC	LM/M	CRI>	KELVIN	L x B x H/L x W x H	VE/PACKAGE	CHF
746-241467tw	LED 14,4W/m	24	519 526	80	2700- 6500	5000 x 12 x 5,5	5m Rolle/5m Roll	153,72

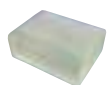

SILIKONENDKAPPE/SILICON END CAP

ART. NR./CODE	CHF
746-1006	1,32



SCHRUMPFSCHLAUCH/SHRINK TUBE

ART. NR./CODE	CHF
746-1004	0,60



EINSPEISUNGSABDECKUNG/FEED IN COVER

ART. NR./CODE	CHF
746-1102	1,32

Flexibles BASIC LED Stripe; 48V Versorgungsspannung, Rolle 10m, 120 LED/M, 5step macadam binning, trennbar alle 10cm, Band muss nach Trennung versiegelt werden! Befestigung durch doppelseitiges 3M Klebeband, exkl. Konverter
ACHTUNG: Keine Beständigkeit gegen chemische Substanzen oder Dämpfe (z.B. Chlor u. dgl.); Um eine lange Lebensdauer und einwandfreie Funktion der LED-Stripes zu garantieren, ist eine Montage auf wärmeleitendem Material Voraussetzung!

Flexible BASIC LED 48V IP67 stripe, roll 10m, 120 LEDs/m, 4,8W/m, separable each 10cm, Stripe must be sealed after separation! fixing with double-sided adhesive tape 3M, without driver
Attention: No resistance to chemical substances or vapours (e.g. chlorine and similar). In order to guarantee a long service life and perfect functioning of the LED stripes, they must be mounted on heat conducting material!

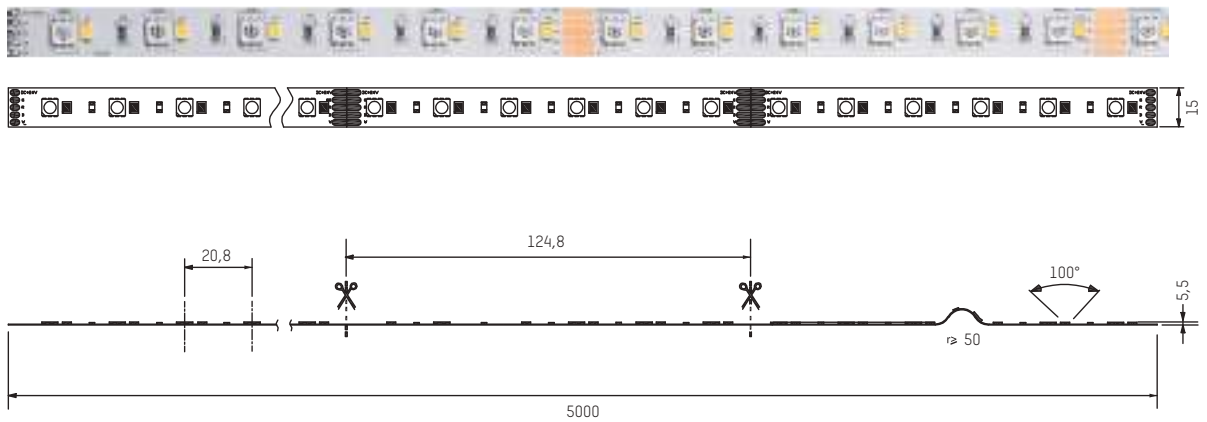

FLEX.light RGBW 18,1W

ACHTUNG: maximale Länge pro Einspeisepunkt 5m LED/
Attention: Maximum length per feed point 5m



ART. NR./CODE	LEISTUNG/POWER	V DC	LM/M	CRI>	KELVIN	L x B x H/L x W x H	VE/PACKAGE	CHF
746-1249167rgbw	LED 18,1W/m	24	78 ■ red 198 ■ green 52 ■ blue 294 white	80 WHITE	RGB+ ■ 3000	5000 x 15 x 5,5	5m Rolle/5m Roll	176,64





Projekt: Dorfbahn, Gerlos, Österreich, Foto: Dorfbahn Gerlos



Projekt: Cafe Central, Linz, Österreich, Foto: LSD

Flexibles BASIC LED Stripe; 48V Versorgungsspannung, Rolle 10m, 120 LED/M, 5step macadam binning, trennbar alle 10cm, Band muss nach Trennung versiegelt werden! Befestigung durch doppelseitiges 3M Klebeband, exkl. Konverter

ACHTUNG: Keine Beständigkeit gegen chemische Substanzen oder Dämpfe (z.B. Chlor u. dgl.); Um eine lange Lebensdauer und einwandfreie Funktion der LED-Stripes zu garantieren, ist eine Montage auf wärmeleitendem Material Voraussetzung!

Flexible BASIC LED 48V IP67 stripe, roll 10m, 120 LEDs/m, 4,8W/m, separable each 10cm, Stripe must be sealed after separation! fixing with double-sided adhesive tape 3M, without driver

Attention: No resistance to chemical substances or vapours (e.g. chlorine and similar).

In order to guarantee a long service life and perfect functioning of the LED stripes, they must be mounted on heat conducting material!

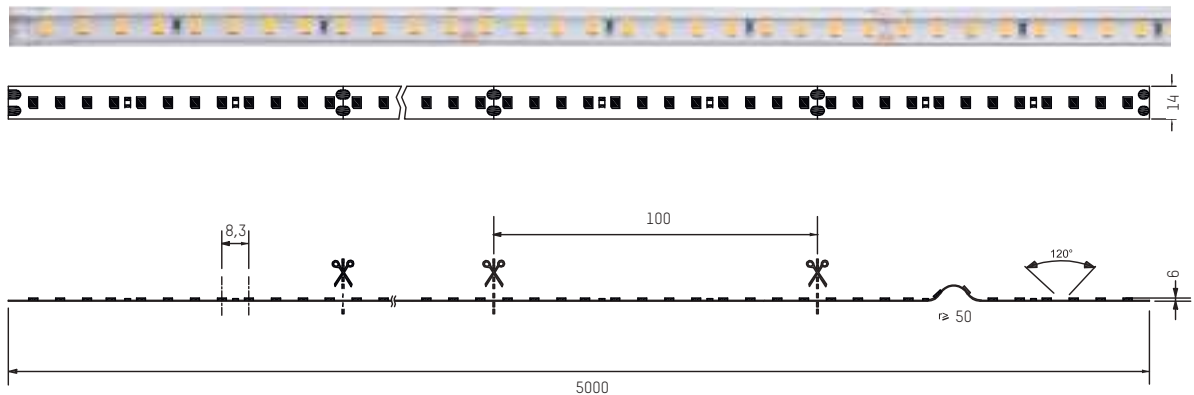

48V

FLEX.light BASIC 48V IP67 4,8W

ACHTUNG: maximale Länge pro Einspeisepunkt 10m LED/
Attention: Maximum length per feed point 10m



ART. NR./CODE	LEISTUNG/POWER	V DC	LM/M	CRI>	KELVIN	L x B x H/L x W x H	VE/PACKAGE	CHF
746-484867ww	LED 4,8W/m	48	418	80	3000	10000 x 14 x 6	10m Rolle/10m Roll	232,56
746-484867nw	LED 4,8W/m	48	420	80	4000	10000 x 14 x 6	10m Rolle/10m Roll	232,56

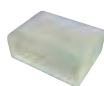

SILIKONENDKAPPE/SILICON END CAP

ART. NR./CODE	CHF
746-1007	1,32



SCHRUMPFSCHLAUCH/SHRINK TUBE

ART. NR./CODE	CHF
746-1004	0,60



EINSPEISUNGSABDECKUNG/FEED IN COVER

ART. NR./CODE	CHF
746-1104	2,52



DC-STECKER/DC PLUG

ART. NR./CODE	INFO	CHF
746-1100	inkl. 130mm Kabel/ incl. 130mm cable	2,52



DC-BUCHSE/DC SOCKET

ART. NR./CODE	INFO	CHF
746-1200	inkl. 130mm Kabel/ incl. 130mm cable	2,52



KONVERTER 50W SCHALTBAR/DRIVER 50W ON/OFF

ART. NR./CODE	INFO	W	V DC	V AC	LxBxH/LxWxH	FARBE/COLOUR	CHF
24-122766	nicht dimmbar/ not dimmable	50	48	230	225 x 60 x 49	<input type="checkbox"/> white	80,04



KONVERTER 150W SCHALTBAR/DRIVER 150W ON/OFF

ART. NR./CODE	INFO	W	V DC	V AC	LxBxH/LxWxH	FARBE/COLOUR	CHF
24-122764	nicht dimmbar/ not dimmable	150	48	230	240 x 60 x 49	<input type="checkbox"/> white	170,28



UNIVERSALDIMMER/UNIVERSALDIMMER

ART. NR./CODE	INFO	V DC	LxBxH/LxWxH	FARBE/COLOUR	CHF
322-ud3000	Universaldimmer 1 Kanal, separater Steuereingang für DALI, 1-10V, Push, Sync Anschluß für bis zu 9 Slaves bei 1-10V oder Push Ansteuerung, max. Anschluß: 5A Zugentlastung separat ordern ZUGENTLASTUNG für 1-Kanal Universaldimmer, 2 Stück	15-50	153 x 30 x 21	<input type="checkbox"/> white	147,60
322-ud7001	Universal dimmer 1 channel, separate control input for DALI, 1-10V, Push, Sync connection for up to 9 slaves with 1-10V or Push control, max. connection: 5A Strain relief to be ordered separately STAIN RELIEF for 1-channel universal dimmer, 2 pcs.				15,24



AUFBAU/EINBAUPROFILE

SURFACE/RECESSED PROFILES



MINI 10 AUFBAU/SURFACE
Info: S. 254/P. 254



MINI 14 AUFBAU/SURFACE
Info: S. 254/P. 254



MINI 17 AUFBAU/SURFACE
Info: S. 255/P. 255



MIDI AUFBAU/SURFACE
Info: S. 255/P. 255



MAXI AUFBAU/SURFACE
Info: S. 256/P. 256

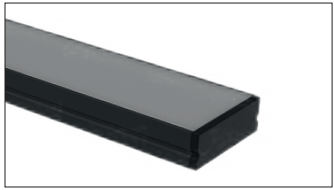

MEGA AUFBAU/SURFACE
Info: S. 256/P. 256



MINI CORNER AUFBAU/SURFACE
Info: S. 257/P. 257

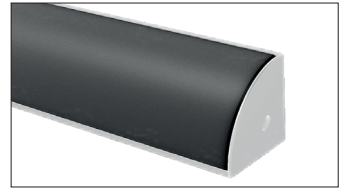

MIDI CORNER AUFBAU/SURFACE
Info: S. 257/P. 257



MIDI CORNER AUFBAU/SURFACE
Info: S. 258/P. 258

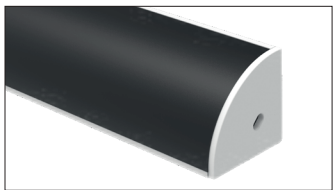

MAXI CORNER AUFBAU/SURFACE
Info: S. 258/P. 258



MAXI CORNER AUFBAU/SURFACE
Info: S. 259/P. 259

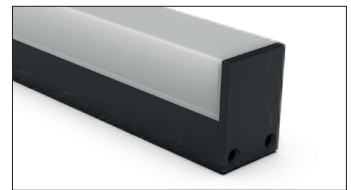

MIDI CUBE AUFBAU/SURFACE
Info: S. 260/P. 260

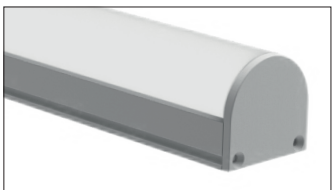

MAXI SOFT AUFBAU/SURFACE
Info: S. 260/P. 260



FLEX AUFBAU/SURFACE
Info: S. 261/P. 261



MINI 10 EINBAU/RECESSED
Info: S. 262/P. 262



MINI 14 EINBAU/RECESSED
Info: S. 262/P. 262



MINI 17 EINBAU/RECESSED
Info: S. 263/P. 263



MIDI EINBAU/RECESSED
Info: S. 263/P. 263



MAXI EINBAU/RECESSED
Info: S. 264/P. 264

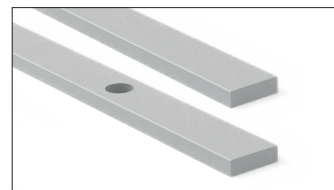

ZUBEHÖR/ACCESSOIRES
Info: S. 264/P. 264



AUFBAUPROFILE AUS ALUMINIUM/SURFACE ALUMINIUM PROFILES

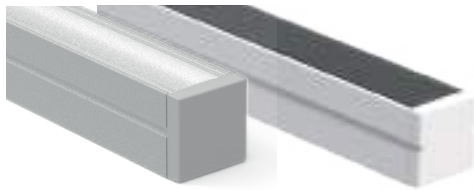

Aufbauprofil MINI 10 für LED Flexbänder bis Breite 5mm

HINWEIS: für LED Bänder bis max. 5 Watt

Surface profile MINI 10 for flexible LED stripes up to width 5mm

INFO: for LED stripes up to: 5 Watt

MINI 10 AUFBAU/MINI 10 SURFACE



ART. NR./CODE	INFO	DETAIL/DETAIL	L x B x H/L x W x H	FARBE/COLOUR	CHF
600-1a201w	Profil/Profile		2000 x 10 x 10	<input type="checkbox"/> white	12,00
600-1a201b	Profil/Profile		2000 x 10 x 10	<input checked="" type="checkbox"/> black	12,00
600-1a201s	Profil/Profile		2000 x 10 x 10	<input type="checkbox"/> alu anodized	12,72
	INFO	DETAIL/DETAIL	MATERIAL/MATERIAL	FARBE/COLOUR	CHF
600-1aek201w	Endkappen (2 Stk.)/End Piece (2 pcs.)		Kunststoff/plastic	<input type="checkbox"/> white	1,32
600-1aek201b	Endkappen (2 Stk.)/End Piece (2 pcs.)		Kunststoff/plastic	<input checked="" type="checkbox"/> black	1,32
600-1aek201s	Endkappen (2 Stk.)/End Piece (2 pcs.)		Kunststoff/plastic	<input type="checkbox"/> grey	1,32
600-1c201	Abdeckung/Cover		PMMA Weiß opal/PMMA white opal	<input type="checkbox"/> white opal	6,00
600-cb201	Abdeckung/Cover		PMMA Schwarz opal/PMMA black opal	<input checked="" type="checkbox"/> black opal	8,40
600-mc201	Montageclips (2 Stk.)/ Mounting Clips (2 pcs.)		Edelstahl/Stainless Steel	<input type="checkbox"/> stainless steel	1,32



Aufbauprofil MINI 14 für LED Flexbänder bis Breite 8mm

HINWEIS: für LED Bänder bis max. 9 Watt

Surface profile MINI 14 for flexible LED stripes up to width 8mm

INFO: for LED stripes up to: 9 Watt

MINI 14 AUFBAU/MINI 14 SURFACE



ART. NR./CODE	INFO	DETAIL/DETAIL	L x B x H/L x W x H	FARBE/COLOUR	CHF
600-1a202w	Profil/Profile		2000 x 14 x 8	<input type="checkbox"/> white	13,20
600-1a202b	Profil/Profile		2000 x 14 x 8	<input checked="" type="checkbox"/> black	12,00
600-1a202s	Profil/Profile		2000 x 14 x 8	<input type="checkbox"/> alu anodized	13,20
	INFO	DETAIL/DETAIL	MATERIAL/MATERIAL	FARBE/COLOUR	CHF
600-1aek202w	Endkappen (2 Stk.)/End Piece (2 pcs.)		Kunststoff/plastic	<input type="checkbox"/> white	1,92
600-1aek202b	Endkappen (2 Stk.)/End Piece (2 pcs.)		Kunststoff/plastic	<input checked="" type="checkbox"/> black	1,92
600-1aek202s	Endkappen (2 Stk.)/End Piece (2 pcs.)		Kunststoff/plastic	<input type="checkbox"/> grey	1,92
600-1c202	Abdeckung/Cover		PMMA Weiß opal/PMMA white opal	<input type="checkbox"/> white opal	8,40
600-cb202	Abdeckung/Cover		PMMA Schwarz opal/PMMA black opal	<input checked="" type="checkbox"/> black opal	8,40
600-amc202	Montageclips (2 Stk.)/ Mounting Clips (2 pcs.)		Edelstahl/Stainless Steel	<input type="checkbox"/> stainless steel	1,32



Aufbauprofil MINI 17 für LED Flexbänder bis Breite 12mm

HINWEIS: für LED Bänder bis max. 18 Watt

Surface profile MINI 17 for flexible LED stripes up to width 12mm

INFO: for LED stripes up to: 18 Watt

MINI 17 AUFBAU/MINI 17 SURFACE



ART. NR./CODE	INFO	DETAIL/DETAIL	L x B x H / L x W x H	FARBE/COLOUR	CHF
600-a203w	Profil/Profile		2000 x 17 x 8,8	<input type="checkbox"/> white	14,40
600-a203b	Profil/Profile		2000 x 17 x 8,8	<input checked="" type="checkbox"/> black	18,00
600-a203s	Profil/Profile		2000 x 17 x 8,8	<input checked="" type="checkbox"/> alu anodized	14,40
	INFO	DETAIL/DETAIL	MATERIAL/MATERIAL	FARBE/COLOUR	CHF
600-aek203w	Endkappen (2 Stk.)/End Piece (2 pcs.)		Kunststoff/plastic	<input type="checkbox"/> white	1,92
600-aek203b	Endkappen (2 Stk.)/End Piece (2 pcs.)		Kunststoff/plastic	<input checked="" type="checkbox"/> black	1,92
600-aek203s	Endkappen (2 Stk.)/End Piece (2 pcs.)		Kunststoff/plastic	<input checked="" type="checkbox"/> grey	1,92
600-c203	Abdeckung/Cover		PMMA Weiß opal/PMMA white opal	<input type="checkbox"/> white opal	8,40
600-mc203	Montageclips (2 Stk.)/ Mounting Clips (2 pcs.)		Edelstahl/Stainless Steel	<input checked="" type="checkbox"/> stainless steel	1,92



Aufbauprofil MIDI für LED Flexbänder bis Breite 15mm

HINWEIS: für LED Bänder bis max. 28 Watt

Surface profile MIDI for flexible LED stripes up to width 15mm

INFO: for LED stripes up to: 28 Watt

MIDI AUFBAU/MIDI SURFACE



ART. NR./CODE	INFO	DETAIL/DETAIL	L x B x H / L x W x H	FARBE/COLOUR	CHF
600-a204w	Profil/Profile		2000 x 23 x 11,2	<input type="checkbox"/> white	21,60
600-a204b	Profil/Profile		2000 x 23 x 11,2	<input checked="" type="checkbox"/> black	21,60
600-a204s	Profil/Profile		2000 x 23 x 11,2	<input checked="" type="checkbox"/> alu anodized	21,60
	INFO	DETAIL/DETAIL	MATERIAL/MATERIAL	FARBE/COLOUR	CHF
600-aek204w	Endkappen (2 Stk.)/End Piece (2 pcs.)		Kunststoff/plastic	<input type="checkbox"/> white	2,52
600-aek204b	Endkappen (2 Stk.)/End Piece (2 pcs.)		Kunststoff/plastic	<input checked="" type="checkbox"/> black	2,52
600-aek204s	Endkappen (2 Stk.)/End Piece (2 pcs.)		Kunststoff/plastic	<input checked="" type="checkbox"/> grey	2,52
600-c204	Abdeckung/Cover		PMMA Weiß opal/PMMA white opal	<input type="checkbox"/> white opal	10,80
600-ck204	Abdeckung/Cover		PMMA transparent/PMMA transparent	<input type="checkbox"/> transparent	10,80
600-mc204	Montageclips (2 Stk.)/ Mounting Clips (2 pcs.)		Edelstahl/Stainless Steel	<input checked="" type="checkbox"/> stainless steel	1,92

AUFBAUPROFILE AUS ALUMINIUM/SURFACE ALUMINIUM PROFILES

Aufbauprofil MAXI für LED Flexbänder
bis Breite 15mm

HINWEIS: für LED Bänder bis max.
28 Watt

Surface profile MAXI for flexible LED
stripes up to width 15mm

INFO: for LED stripes up to: 28 Watt

MAXI AUFBAU/MAXI SURFACE

ART. NR./CODE	INFO	DETAIL/DETAIL	LxBxH/LxWxH	FARBE/COLOUR	CHF
600-a205w	Profil/Profile		2000 x 23 x 25	<input type="checkbox"/> white	34,80
600-a205b	Profil/Profile		2000 x 23 x 25	<input checked="" type="checkbox"/> black	34,80
600-a205s	Profil/Profile		2000 x 23 x 25	<input checked="" type="checkbox"/> alu anodized	34,80
	INFO	DETAIL/DETAIL	MATERIAL/MATERIAL	FARBE/COLOUR	CHF
600-aek205w	Endkappen (2 Stk.)/End Piece (2 pcs.)		Kunststoff/plastic	<input type="checkbox"/> white	3,12
600-aek205b	Endkappen (2 Stk.)/End Piece (2 pcs.)		Kunststoff/plastic	<input checked="" type="checkbox"/> black	3,48
600-aek205s	Endkappen (2 Stk.)/End Piece (2 pcs.)		Kunststoff/plastic	<input checked="" type="checkbox"/> grey	3,12
600-aekc205w	Endkappen (2 Stk.)/End Piece (2 pcs.)		Kunststoff (H 25 mm)/plastic	<input type="checkbox"/> white	3,12
600-aekc205b	Endkappen (2 Stk.)/End Piece (2 pcs.)		Kunststoff (H 25 mm)/plastic	<input checked="" type="checkbox"/> black	3,12
600-aekc205s	Endkappen (2 Stk.)/End Piece (2 pcs.)		Kunststoff (H 25 mm)/plastic	<input checked="" type="checkbox"/> grey	3,12
600-c205	Abdeckung flach/Cover flat		PMMA Weiß opal/PMMA white opal	<input type="checkbox"/> white opal	10,80
600-cu205	Abdeckung kubisch/Cover cubic		PMMA Weiß opal/PMMA white opal	<input type="checkbox"/> white opal	22,80
600-cb205	Abdeckung flach/Cover flat		PMMA Schwarz opal/PMMA black opal	<input checked="" type="checkbox"/> black opal	12,00
600-amc205	Montageclips (2 Stk.)/ Mounting Clips (2 pcs.)		Edelstahl/Stainless Steel	<input checked="" type="checkbox"/> stainless steel	2,52



Aufbauprofil MEGA für LED Flexbänder
bis Breite 15mm

HINWEIS: für LED Bänder bis max.
28 Watt

Surface profile MEGA for flexible LED
stripes up to width 15mm

INFO: for LED stripes up to: 28 Watt

MEGA AUFBAU/MEGA SURFACE

ART. NR./CODE	INFO	DETAIL/DETAIL	LxBxH/ LxWxH	FARBE/COLOUR	CHF
600-a206w	Profil/Profile		2000 x 30 x 10,1	<input type="checkbox"/> white	22,80
600-a206b	Profil/Profile		2000 x 30 x 10,1	<input checked="" type="checkbox"/> black	22,80
600-a206s	Profil/Profile		2000 x 30 x 10,1	<input checked="" type="checkbox"/> alu anodized	28,80
	INFO	DETAIL/DETAIL	MATERIAL/MATERIAL	FARBE/COLOUR	CHF
600-aek206w	Endkappen (2 Stk.)/End Piece (2 pcs.)		Kunststoff/plastic	<input type="checkbox"/> white	3,12
600-aek206b	Endkappen (2 Stk.)/End Piece (2 pcs.)		Kunststoff/plastic	<input checked="" type="checkbox"/> black	3,12
600-aek206s	Endkappen (2 Stk.)/End Piece (2 pcs.)		Kunststoff/plastic	<input checked="" type="checkbox"/> grey	3,12
600-c206	Abdeckung/Cover		PMMA Weiß opal/PMMA white opal	<input type="checkbox"/> white opal	10,80
600-amc206	Montageclips (2 Stk.)/ Mounting Clips (2 pcs.)		Edelstahl/Stainless Steel	<input checked="" type="checkbox"/> stainless steel	2,52



Aufbauprofil MINI CORNER für LED Flexbänder bis Breite 8mm

HINWEIS: für LED Bänder bis max. 12 Watt

Surface profile MINI CORNER for flexible LED stripes up to width 8mm

INFO: for LED stripes up to: 12 Watt

MINI CORNER AUFBAU/MINI CORNER SURFACE



ART. NR./CODE	INFO	DETAIL/DETAIL	LxBxH/LxWxH	FARBE/COLOUR	CHF
600-1a209w	Profil/Profile		2000 x 18,5 x 18,5	<input type="checkbox"/> white	26,40
600-1a209b	Profil/Profile		2000 x 18,5 x 18,5	<input checked="" type="checkbox"/> black	26,40
600-1a209s	Profil/Profile		2000 x 18,5 x 18,5	<input checked="" type="checkbox"/> alu anodized	26,40
	INFO	DETAIL/DETAIL	MATERIAL/MATERIAL	FARBE/COLOUR	CHF
600-1aek209w	Endkappen (2 Stk.)/End Piece (2 pcs.)		Kunststoff/plastic	<input type="checkbox"/> white	2,52
600-1aek209b	Endkappen (2 Stk.)/End Piece (2 pcs.)		Kunststoff/plastic	<input checked="" type="checkbox"/> black	2,52
600-1aek209s	Endkappen (2 Stk.)/End Piece (2 pcs.)		Kunststoff/plastic	<input checked="" type="checkbox"/> alu anodized	2,52
600-1c209	Abdeckung/Cover		PMMA Weiß opal/PMMA white opal	<input type="checkbox"/> white opal	8,40
600-amc209	Montageclips (2 Stk.)/ Mounting Clips (2 pcs.)		Edelstahl/Stainless Steel	<input checked="" type="checkbox"/> stainless steel	2,52



Aufbauprofil MIDI CORNER für LED Flexbänder bis Breite 8mm

HINWEIS: für LED Bänder bis max. 9 Watt

Surface profile MIDI CORNER for flexible LED stripes up to width 8mm

INFO: for LED stripes up to: 9 Watt

MIDI CORNER AUFBAU/MIDI CORNER SURFACE



ART. NR./CODE	INFO	DETAIL/DETAIL	LxBxH/LxWxH	FARBE/COLOUR	CHF
600-a207w	Profil/Profile		2000 x 16 x 16	<input type="checkbox"/> white	22,80
600-a207b	Profil/Profile		2000 x 16 x 16	<input checked="" type="checkbox"/> black	19,20
600-a207s	Profil/Profile		2000 x 16 x 16	<input checked="" type="checkbox"/> alu anodized	19,20
	INFO	DETAIL/DETAIL	MATERIAL/MATERIAL	FARBE/COLOUR	CHF
600-aekr207w	Endkappen (2 Stk.)/End Piece (2 pcs.)		Kunststoff/plastic	<input type="checkbox"/> white	3,00
600-aekr207b	Endkappen (2 Stk.)/End Piece (2 pcs.)		Kunststoff/plastic	<input checked="" type="checkbox"/> black	2,52
600-aekr207s	Endkappen (2 Stk.)/End Piece (2 pcs.)		Kunststoff/plastic	<input checked="" type="checkbox"/> grey	2,52
600-cr207	Abdeckung/Cover		PMMA Weiß opal/PMMA white opal	<input type="checkbox"/> white opal	9,60
600-crb207	Abdeckung/Cover		PMMA Schwarz opal/PMMA black opal	<input checked="" type="checkbox"/> black opal	10,80
600-amc207	Montageclips (2 Stk.)/ Mounting Clips (2 pcs.)		Edelstahl/Stainless Steel	<input checked="" type="checkbox"/> stainless steel	2,28



Aufbauprofil MIDI CORNER für LED Flexbänder bis Breite 8mm

HINWEIS: für LED Bänder bis max. 9 Watt

Surface profile MIDI CORNER for flexible LED stripes up to width 8mm

INFO: for LED stripes up to: 9 Watt

MIDI CORNER AUFBAU/MIDI CORNER SURFACE



ART. NR./CODE	INFO	DETAIL/DETAIL	L x B x H / L x W x H	FARBE/COLOUR	CHF
600-a207w	Profil/Profile		2000 x 16 x 16	<input type="checkbox"/> white	22,80
600-a207b	Profil/Profile		2000 x 16 x 16	<input checked="" type="checkbox"/> black	19,20
600-a207s	Profil/Profile		2000 x 16 x 16	<input type="checkbox"/> alu anodized	19,20
	INFO	DETAIL/DETAIL	MATERIAL/MATERIAL	FARBE/COLOUR	CHF
600-aek207w	Endkappen (2 Stk.)/End Piece (2 pcs.)		Kunststoff/plastic	<input type="checkbox"/> white	1,92
600-aek207b	Endkappen (2 Stk.)/End Piece (2 pcs.)		Kunststoff/plastic	<input checked="" type="checkbox"/> black	1,92
600-aek207s	Endkappen (2 Stk.)/End Piece (2 pcs.)		Kunststoff/plastic	<input type="checkbox"/> grey	1,92
600-c207	Abdeckung/Cover		PMMA Weiß opal/PMMA white opal	<input type="checkbox"/> white opal	10,80
600-cb207	Abdeckung/Cover		PMMA Schwarz opal/PMMA black opal	<input checked="" type="checkbox"/> black opal	10,80
600-amc207	Montageclips (2 Stk.)/ Mounting Clips (2 pcs.)		Edelstahl/Stainless Steel	<input type="checkbox"/> stainless steel	2,28



Aufbauprofil MAXI CORNER für LED Flexbänder bis Breite 15mm

HINWEIS: für LED Bänder bis max. 28 Watt

Surface profile MAXI CORNER for flexible LED stripes up to width 15mm

INFO: for LED stripes up to: 28 Watt

MAXI CORNER AUFBAU/MAXI CORNER SURFACE



ART. NR./CODE	INFO	DETAIL/DETAIL	L x B x H / L x W x H	FARBE/COLOUR	CHF
600-a208w	Profil/Profile		2000 x 30 x 30	<input type="checkbox"/> white	33,00
600-a208b	Profil/Profile		2000 x 30 x 30	<input checked="" type="checkbox"/> black	30,00
600-a208s	Profil/Profile		2000 x 30 x 30	<input type="checkbox"/> alu anodized	30,00
	INFO	DETAIL/DETAIL	MATERIAL/MATERIAL	FARBE/COLOUR	CHF
600-aekr208w	Endkappen (2 Stk.)/End Piece (2 pcs.)		Kunststoff/plastic	<input type="checkbox"/> white	2,76
600-aekr208b	Endkappen (2 Stk.)/End Piece (2 pcs.)		Kunststoff/plastic	<input checked="" type="checkbox"/> black	2,52
600-aekr208s	Endkappen (2 Stk.)/End Piece (2 pcs.)		Kunststoff/plastic	<input type="checkbox"/> grey	2,52
600-cr208	Abdeckung/Cover		PMMA Weiß opal/PMMA white opal	<input type="checkbox"/> white opal	21,60
600-crb208	Abdeckung/Cover		PMMA Schwarz opal/PMMA black opal	<input checked="" type="checkbox"/> black opal	22,80
600-amc208	Montageclips (2 Stk.)/ Mounting Clips (2 pcs.)		Edelstahl/Stainless Steel	<input type="checkbox"/> stainless steel	3,12



Aufbauprofil MAXI CORNER für LED
Flexbänder bis Breite 15mm

HINWEIS: für LED Bänder bis max.
28 Watt

Surface profile MAXI CORNER for fle-
xible LED stripes up to width 15mm

INFO: for LED stripes up to: 28 Watt

MAXI CORNER AUFBAU/MAXI CORNER SURFACE



ART. NR./CODE	INFO	DETAIL/DETAIL	LxBxH/ LxWxH	FARBE/COLOUR	CHF
600-a208w	Profil/Profile		2000 x 30 x 30	<input type="checkbox"/> white	33,00
600-a208b	Profil/Profile		2000 x 30 x 30	<input checked="" type="checkbox"/> black	30,00
600-a208s	Profil/Profile		2000 x 30 x 30	<input type="checkbox"/> alu anodized	30,00
	INFO	DETAIL/DETAIL	MATERIAL/MATERIAL	FARBE/COLOUR	CHF
600-aek208w	Endkappen (2 Stk.)/End Piece (2 pcs.)		Kunststoff/plastic	<input type="checkbox"/> white	2,52
600-aek208b	Endkappen (2 Stk.)/End Piece (2 pcs.)		Kunststoff/plastic	<input checked="" type="checkbox"/> black	2,52
600-aek208s	Endkappen (2 Stk.)/End Piece (2 pcs.)		Kunststoff/plastic	<input type="checkbox"/> grey	2,52
600-c208	Abdeckung/Cover		PMMA Weiß opal/PMMA white opal	<input type="checkbox"/> white opal	21,60
600-cb208	Abdeckung/Cover		PMMA Schwarz opal/PMMA black opal	<input checked="" type="checkbox"/> black opal	22,80
600-amc208	Montageclips (2 Stk.)/ Mounting Clips (2 pcs.)		Edelstahl/Stainless Steel	<input type="checkbox"/> stainless steel	3,12



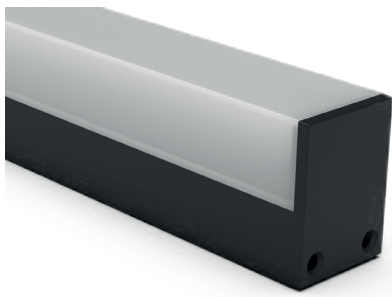

Aufbauprofil MIDI CUBE für LED Flexbänder bis Breite 12mm,
HINWEIS: für LED Bänder bis max. 15 Watt

Surface profile MIDI CUBE for flexible LED stripes up to width 12mm,
INFO: for LED Stripes up to: 15 Watt

MIDI CUBE AUFBAU/MIDI CUBE SURFACE



ART. NR./CODE	INFO	DETAIL/DETAIL	L x B x H / L x W x H	FARBE/COLOUR	CHF
600-a211w	Profil/Profile		2000 x 20 x 27	<input type="checkbox"/> white	33,60
600-a211b	Profil/Profile		2000 x 20 x 27	<input checked="" type="checkbox"/> black	33,60
600-a211s	Profil/Profile		2000 x 20 x 27	<input checked="" type="checkbox"/> alu anodized	33,60
	INFO	DETAIL/DETAIL	MATERIAL/MATERIAL	FARBE/COLOUR	CHF
600-aek211w	Endkappen (2 Stk.)/End Piece (2 pcs.)		Kunststoff/plastic	<input type="checkbox"/> white	2,52
600-aek211b	Endkappen (2 Stk.)/End Piece (2 pcs.)		Kunststoff/plastic	<input checked="" type="checkbox"/> black	2,52
600-aek211s	Endkappen (2 Stk.)/End Piece (2 pcs.)		Kunststoff/plastic	<input checked="" type="checkbox"/> silver	2,52
600-c211	Abdeckung/Cover		PMMA Weiß opal/PMMA white opal	<input type="checkbox"/> white opal	13,20
600-amc211	Montageclips (2 Stk.)/ Mounting Clips (2 pcs.)		Edelstahl/Stainless Steel	<input checked="" type="checkbox"/> stainless steel	2,52

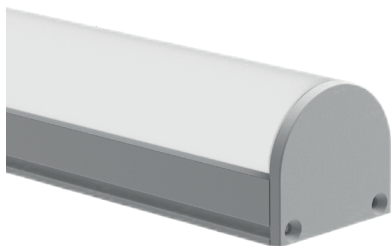

Aufbauprofil MAXI CUBE SOFT für LED Flexbänder bis Breite 18mm,
HINWEIS: für LED Bänder bis max. 12 Watt

Surface profile MAXI CUBE SOFT for flexible LED stripes up to width 18mm,
INFO: for LED Stripes up to: 12 Watt

MAXI SOFT AUFBAU/MAXI SOFT SURFACE



ART. NR./CODE	INFO	DETAIL/DETAIL	L x B x H / L x W x H	FARBE/COLOUR	CHF
600-a210w	Profil/Profile		2000 x 26,7 x 24,4	<input type="checkbox"/> white	30,00
600-a210b	Profil/Profile		2000 x 26,7 x 24,4	<input checked="" type="checkbox"/> black	30,00
600-a210s	Profil/Profile		2000 x 26,7 x 24,4	<input checked="" type="checkbox"/> alu anodized	30,00
	INFO	DETAIL/DETAIL	MATERIAL/MATERIAL	FARBE/COLOUR	CHF
600-aek210w	Endkappen (2 Stk.)/End Piece (2 pcs.)		Kunststoff/plastic	<input type="checkbox"/> white	2,52
600-aek210b	Endkappen (2 Stk.)/End Piece (2 pcs.)		Kunststoff/plastic	<input checked="" type="checkbox"/> black	2,52
600-aek210s	Endkappen (2 Stk.)/End Piece (2 pcs.)		Kunststoff/plastic	<input checked="" type="checkbox"/> silver	2,52
600-c210	Abdeckung/Cover		PMMA Weiß opal/PMMA white opal	<input type="checkbox"/> white opal	12,00
600-amc210	Montageclips (2 Stk.)/ Mounting Clips (2 pcs.)		Edelstahl/Stainless Steel	<input checked="" type="checkbox"/> stainless steel	2,52



Aufbauprofil FLEX für LED Flexbänder bis Breite 12mm,

HINWEIS: für LED Bänder bis max. 9 Watt

Surface profile FLEX for flexible LED stripes up to width 12mm,

INFO: for LED Stripes up to: 9 Watt

FLEX AUFBAU/FLEX SURFACE



ART. NR./CODE	INFO	DETAIL/DETAIL	LxBxH/ LxWxH	FARBE/COLOUR	CHF
600-a212s	Profil max. Biegeradius:200 mm/ Profile max. bending radius: 200 mm		2000 x 17,8 x 5,1	<input checked="" type="checkbox"/> alu anodized	18,00
600-aek212s	Endkappen (2 Stk.)/End Piece (2 pcs.)		Kunststoff/plastic	<input checked="" type="checkbox"/> silver	2,40
600-c212	Abdeckung/Cover		PMMA Weiß opal/PMMA white opal	<input type="checkbox"/> white opal	8,40
600-amc212	Montageclips (2 Stk.)/ Mounting Clips (2 pcs.)		Edelstahl/Stainless Steel	<input checked="" type="checkbox"/> stainless steel	2,40



EINBAUPROFILE AUS ALUMINIUM/RECESSED ALUMINIUM PROFILES

Einbauprofil MINI 10 für LED Flexbänder bis Breite 5mm

HINWEIS: für LED Bänder bis max. 5 Watt, ET: 15mm, Ausschnitt: B: 12mm; Bei Verwendung von Endkappen: Profillänge + 4mm

Recessed profile MINI 10 for flexible LED stripes up to width 5mm

INFO: for LED stripes up to: 5 Watt, ID: 15mm, cutout: W: 12mm; when using end caps: add +4mm to profile length

MINI 10 EINBAU/MINI 10 RECESSED

ART. NR./CODE	INFO	DETAIL/DETAIL	L x B x H/L x W x H	FARBE/COLOUR	CHF
600-1e201w	Profil/Profile		2000 x 18 x 13	<input type="checkbox"/> white	22,80
600-1e201b	Profil/Profile		2000 x 18 x 13	<input checked="" type="checkbox"/> black	22,80
600-1e201s	Profil/Profile		2000 x 18 x 13	<input type="checkbox"/> alu anodized	22,80
	INFO	DETAIL/DETAIL	MATERIAL/MATERIAL	FARBE/COLOUR	CHF
600-1eek201w	Endkappen (2 Stk.)/End Piece (2 pcs.)		Kunststoff/plastic	<input type="checkbox"/> white	1,92
600-1eek201b	Endkappen (2 Stk.)/End Piece (2 pcs.)		Kunststoff/plastic	<input checked="" type="checkbox"/> black	1,92
600-1eek201s	Endkappen (2 Stk.)/End Piece (2 pcs.)		Kunststoff/plastic	<input type="checkbox"/> grey	1,92
600-0c201	Abdeckung/Cover		PMMA Weiß opal/PMMA white opal	<input type="checkbox"/> white opal	6,36
600-cb201	Abdeckung/Cover		PMMA Schwarz opal/PMMA black opal	<input checked="" type="checkbox"/> black opal	8,40
600-mc201	Montageclips (2 Stk.)/ Mounting Clips (2 pcs.)		Edelstahl/Stainless Steel	<input type="checkbox"/> stainless steel	1,32



Einbauprofil MINI 14 für LED Flexbänder bis Breite 8mm

HINWEIS: für LED Bänder bis max. 9 Watt, ET: 15mm, Ausschnitt: B: 16mm; Bei Verwendung von Endkappen: Profillänge + 4mm

Recessed profile MINI 14 for flexible LED stripes up to width 8mm

INFO: for LED stripes up to: 9 Watt, ID: 15mm, cutout: W: 16mm; when using end caps: add +4mm to profile length

MINI 14 EINBAU/MINI 14 RECESSED

ART. NR./CODE	INFO	DETAIL/DETAIL	L x B x H/L x W x H	FARBE/COLOUR	CHF
600-1e202w	Profil/Profile		2000 x 22 x 13	<input type="checkbox"/> white	22,80
600-1e202b	Profil/Profile		2000 x 22 x 13	<input checked="" type="checkbox"/> black	22,80
600-1e202s	Profil/Profile		2000 x 22 x 13	<input type="checkbox"/> alu anodized	22,80
	INFO	DETAIL/DETAIL	MATERIAL/MATERIAL	FARBE/COLOUR	CHF
600-1eek202w	Endkappen (2 Stk.)/End Piece (2 pcs.)		Kunststoff/plastic	<input type="checkbox"/> white	1,92
600-1eek202b	Endkappen (2 Stk.)/End Piece (2 pcs.)		Kunststoff/plastic	<input checked="" type="checkbox"/> black	1,92
600-1eek202s	Endkappen (2 Stk.)/End Piece (2 pcs.)		Kunststoff/plastic	<input type="checkbox"/> grey	1,92
600-1c202	Abdeckung/Cover		PMMA Weiß opal/PMMA white opal	<input type="checkbox"/> white opal	7,00
600-cb202	Abdeckung/Cover		PMMA Schwarz opal/PMMA black opal	<input checked="" type="checkbox"/> black opal	7,00
600-emc202	Montageclips (2 Stk.)/ Mounting Clips (2 pcs.)		Edelstahl/Stainless Steel	<input type="checkbox"/> stainless steel	1,10



Einbauprofil MINI 17 für LED Flexbänder bis Breite 12mm

HINWEIS: für LED Bänder bis max. 18 Watt, ET: 11mm, Ausschnitt: B: 19mm; Bei Verwendung von Endkappen: Profillänge + 4mm

Recessed profile MINI 17 for flexible LED stripes up to width 12mm

INFO: for LED stripes up to: 18 Watt, ID: 11mm, cutout: W: 19mm; when using end caps: add +4mm to profile length

MINI 17 EINBAU/MINI 17 RECESSED



ART. NR./CODE	INFO	DETAIL/DETAIL	LxBxH/LxWxH	FARBE/COLOUR	CHF
600-e203w	Profil/Profile		2000 x 24 x 9	<input type="checkbox"/> white	22,80
600-e203b	Profil/Profile		2000 x 24 x 9	<input checked="" type="checkbox"/> black	22,80
600-e203s	Profil/Profile		2000 x 24 x 9	<input checked="" type="checkbox"/> alu anodized	22,80
	INFO	DETAIL/DETAIL	MATERIAL/MATERIAL	FARBE/COLOUR	CHF
600-eek203w	Endkappen (2 Stk.)/End Piece (2 pcs.)		Kunststoff/plastic	<input type="checkbox"/> white	2,52
600-eek203b	Endkappen (2 Stk.)/End Piece (2 pcs.)		Kunststoff/plastic	<input checked="" type="checkbox"/> black	2,52
600-eek203s	Endkappen (2 Stk.)/End Piece (2 pcs.)		Kunststoff/plastic	<input checked="" type="checkbox"/> grey	2,52
600-c203	Abdeckung/Cover		PMMA Weiß opal/PMMA white opal	<input type="checkbox"/> white opal	8,40
600-mc203	Montageclips (2 Stk.)/Mounting Clips (2 pcs.)		Edelstahl/Stainless Steel	<input checked="" type="checkbox"/> stainless steel	1,92



Einbauprofil MIDI für LED Flexbänder bis Breite 15mm

HINWEIS: für LED Bänder bis max. 28 Watt, ET: 15mm, Ausschnitt: B: 24mm; Bei Verwendung von Endkappen: Profillänge + 4mm

Recessed profile MIDI for flexible LED stripes up to width 15mm

INFO: for LED stripes up to: 28 Watt, ID: 15mm, cutout: W: 24mm; when using end caps: add +4mm to profile length

MIDI EINBAU/MIDI RECESSED



ART. NR./CODE	INFO	DETAIL/DETAIL	LxBxH/LxWxH	FARBE/COLOUR	CHF
600-e204w	Profil/Profile		2000 x 30 x 11,2	<input type="checkbox"/> white	22,80
600-e204b	Profil/Profile		2000 x 30 x 11,2	<input checked="" type="checkbox"/> black	22,80
600-e204s	Profil/Profile		2000 x 30 x 11,2	<input checked="" type="checkbox"/> alu anodized	22,80
	INFO	DETAIL/DETAIL	MATERIAL/MATERIAL	FARBE/COLOUR	CHF
600-eek204w	Endkappen (2 Stk.)/End Piece (2 pcs.)		Kunststoff/plastic	<input type="checkbox"/> white	2,52
600-eek204b	Endkappen (2 Stk.)/End Piece (2 pcs.)		Kunststoff/plastic	<input checked="" type="checkbox"/> black	2,52
600-eek204s	Endkappen (2 Stk.)/End Piece (2 pcs.)		Kunststoff/plastic	<input checked="" type="checkbox"/> grey	2,52
600-c204	Abdeckung/Cover		PMMA Weiß opal/PMMA white opal	<input type="checkbox"/> white opal	10,80
600-ck204	Abdeckung/Cover		PMMA klar/PMMA clear	<input type="checkbox"/> clear	10,80
600-mc204	Montageclips (2 Stk.)/Mounting Clips (2 pcs.)		Edelstahl/Stainless Steel	<input checked="" type="checkbox"/> stainless steel	1,92
600-emc204	Montageclips (2 Stk.)/Mounting Clips (2 pcs.)		Edelstahl/Stainless Steel	<input checked="" type="checkbox"/> stainless steel	8,40

EINBAUPROFILE AUS ALUMINIUM/RECESSED ALUMINIUM PROFILES

Einbauprofil MAXI für LED Flexbänder bis Breite 15mm

HINWEIS: für LED Bänder bis max. 28 Watt, ET: 28mm, Ausschnitt: B: 24mm; Bei Verwendung von Endkappen: Profillänge + 4mm

Recessed profile MAXI for flexible LED stripes up to width 15mm

INFO: for LED stripes up to: 28 Watt, ID: 28mm, cutout: W: 24mm; when using end caps: add +4mm to profile length

MAXI EINBAU/MAXI RECESSED

ART. NR./CODE	INFO	DETAIL/DETAIL	LxBxH/LxWxH	FARBE/COLOUR	CHF
600-e205w	Profil/Profile		2000 x 37 x 25	<input type="checkbox"/> white	34,80
600-e205b	Profil/Profile		2000 x 37 x 25	<input checked="" type="checkbox"/> black	34,80
600-e205s	Profil/Profile		2000 x 37 x 25	<input checked="" type="checkbox"/> alu anodized	42,00
	INFO	DETAIL/DETAIL	MATERIAL/MATERIAL	FARBE/COLOUR	CHF
600-eek205w	Endkappen (2 Stk.)/End Piece (2 pcs.)		Kunststoff/plastic	<input type="checkbox"/> white	3,12
600-eek205b	Endkappen (2 Stk.)/End Piece (2 pcs.)		Kunststoff/plastic	<input checked="" type="checkbox"/> black	3,12
600-eek205s	Endkappen (2 Stk.)/End Piece (2 pcs.)		Kunststoff/plastic	<input checked="" type="checkbox"/> grey	3,12
600-eekc205w	Endkappen (2 Stk.)/End Piece (2 pcs.)		Kunststoff/plastic	<input type="checkbox"/> white	3,84
600-eekc205b	Endkappen (2 Stk.)/End Piece (2 pcs.)		Kunststoff/plastic	<input checked="" type="checkbox"/> black	3,84
600-eekc205s	Endkappen (2 Stk.)/End Piece (2 pcs.)		Kunststoff/plastic	<input checked="" type="checkbox"/> grey	3,84
600-c205	Abdeckung flach/Cover flat		PMMA Weiß opal/PMMA white opal	<input type="checkbox"/> white opal	10,80
600-cu205	Abdeckung kubisch/Cover cubic		PMMA Weiß opal/PMMA white opal	<input type="checkbox"/> white opal	22,80
600-cb205	Abdeckung flach/Cover flat		PMMA Schwarz opal/PMMA black opal	<input checked="" type="checkbox"/> black opal	12,00
600-emc205	Montageclips (2 Stk.)/ Mounting Clips (2 pcs.)		Edelstahl/Stainless Steel	<input checked="" type="checkbox"/> stainless steel	8,40

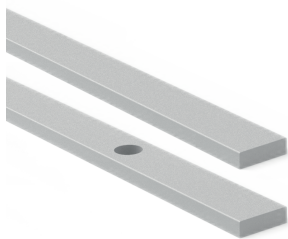
ZUBEHÖR/ACCESSOIRES



ART. NR./CODE	INFO	LxBxH/LxWxH	FARBE/COLOUR	CHF
600-1000	Alustreifen	1000 x 10 x 3	<input checked="" type="checkbox"/> alu nature	7,20
600-1000b	Alustreifen mit Bohrungen	1000 x 10 x 3	<input checked="" type="checkbox"/> alu nature	13,20
600-3000	Alustreifen	3000 x 10 x 3	<input checked="" type="checkbox"/> alu nature	20,40
600-3000b	Alustreifen mit Bohrungen	3000 x 10 x 3	<input checked="" type="checkbox"/> alu nature	34,80



STEUERUNGEN, NETZGERÄTE
CONTROLS, DRIVERS

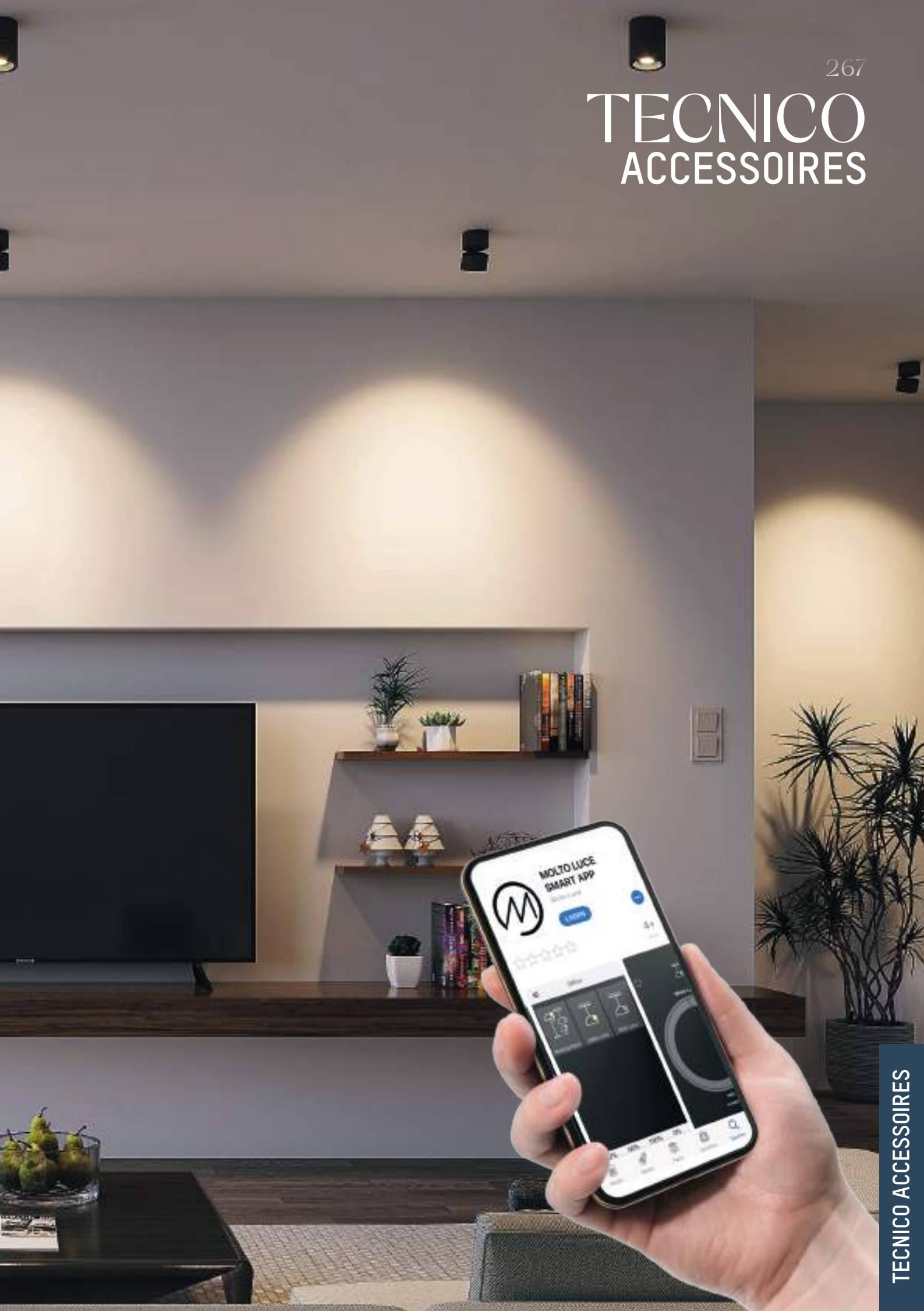

TECNICO ACCESSOIRES





KONVERTER SLIM/U/DRIVER SLIM/U

ART. NR./CODE	INFO	W	V DC	LxBxH/IDxLxWxH	FARBE/COLOUR	CHF
24-141122	Konverter für Strips, nicht dimmbar, 230 V AC/ driver for Strips, not dimmable, 230 V AC	13	24	158 x 22 x 19	<input type="checkbox"/> white	33,60

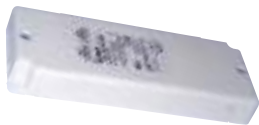

KONVERTER EFU/DRIVER EFU

ART. NR./CODE	INFO	W	V DC	LxBxH/LxWxH	FARBE/COLOUR	CHF
24-141126	Konverter für Strips, nicht dimmbar, 230 V AC/ driver for Strips, not dimmable, 230 V AC	25	24	146 x 55 x 19	<input type="checkbox"/> white	29,40



KONVERTER VPS LP/DRIVER VPS LP

ART. NR./CODE	INFO	W	V DC	LxBxH/LxWxH	FARBE/COLOUR	CHF
24-127903	Konverter für Strips, nicht dimmbar, 230 V AC/ driver for Strips, not dimmable, 230 V AC	50	24	167 x 59 x 28,5	<input type="checkbox"/> white	77,52
24-127905		75	24	184 x 61 x 28,5	<input type="checkbox"/> white	97,80



KONVERTER LCV/DRIVER LCV

ART. NR./CODE	INFO	W	V DC	V AC	LxBxH/LxWxH	FARBE/COLOUR	CHF
24-127821	Konverter für Strips, nicht dimmbar, 230 V AC, schaltbar/ driver for Strips, not dimmable, 230 V AC, switchable	60	24	230	180 x 52 x 30	<input type="checkbox"/> white	35,64
24-127824		120	24	230	300 x 40 x 30	<input type="checkbox"/> white	49,56

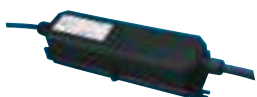

KONVERTER ST2 IP67/DRIVER ST2 IP67

ART. NR./CODE	INFO	W	V DC	LxBxH/LxWxH	FARBE/COLOUR	CHF
24-122479	Konverter für Strips, nicht dimmbar, 230V AC/ driver for Strips, not dimmable, 230V AC	70	24	225 x 66 x 51	■ black	170,28
24-122511		150	24	225 x 66 x 51	■ black	362,16



KONVERTER DC 50W 48V VST/DRIVER DC 50W 48V VST

ART. NR./CODE	INFO	W	V DC	V AC	LxBxH/LxWxH	FARBE/COLOUR	CHF
24-122766	nicht dimmbar/ not dimmable	50	48	230	225 x 60 x 49	□ white	80,04



KONVERTER DC 150W 48V VST/DRIVER DC 150W 48V VST

ART. NR./CODE	INFO	W	V DC	V AC	LxBxH/LxWxH	FARBE/COLOUR	CHF
24-122764	nicht dimmbar/ not dimmable	150	48	230	240 x 60 x 49	□ white	170,28



KONVERTER VST/DRIVER VST

ART. NR./CODE	INFO	W	V DC	LxBxH/LxWxH	FARBE/COLOUR	CHF
24-122752	Konverter für Stripes, nicht dimmbar 230V AC/ driver for stripes, not dimmable 230V AC	50	24	225 x 60 x 36	□ white	82,56
24-122750		70	24	225 x 60 x 36	□ white	91,44
24-122754n		150	24	240 x 60 x 49	■ black	124,56

KONSTANTSPANNUNGSKONVERTER DIMMBAR/CONSTANT VOLTAGE DRIVER DIMMABLE

KONVERTER VSTR 1-10V PUSH IR/DRIVER VSTR 1-10V PUSH IR

ART. NR./CODE	INFO	W	V DC	LxBxH/LxWxH	FARBE/COLOUR	CHF
24-122730	Konverter für Strips, dimmbar 1-10V & Push Dimm., IR-Zubehör separat ordern (IR-Empfänger inkl. 2m Kabel 24-122093 + IR-Fernbedienung 24-150120A)/ driver for Strips, dimmable 1-10V & Push dimm., order IR accessory separately (IR receiver incl. 2m cable 24-122093 + IR remote control 24-150120A)	3x 40 (RGB) 1x 100 white	24	240 x 60 x 49	<input type="checkbox"/> white	260,52

KONVERTER QT DALI/DRIVER QT DALI

ART. NR./CODE	INFO	W	V DC	V AC	LxBxH/LxWxH	FARBE/COLOUR	CHF
28-177900	Konverter für Stripes DALI dimmbar, 230V AC/ driver for Stripes DALI dimmable, 230V AC	50	24	230	346 x 32 x 22	<input type="checkbox"/> white	150,00
28-177924		80	24	230	346 x 32 x 22	<input type="checkbox"/> white	193,20

KONVERTER DALI PUSH/DRIVER DALI PUSH

ART. NR./CODE	INFO	W	V DC	V AC	LxBxH/LxWxH	FARBE/COLOUR	CHF
711-241501dt6	Konverter für Stripes, dimmbar DALI Push Dimm. 1 KANAL/ driver for Stripes, dimmable DALI Push dimm. 1 CHANNEL	150	24	230	365 x 43 x 30	<input type="checkbox"/> white	293,52

KONVERTER DALI DT8 PUSH/DRIVER DALI DT8 PUSH

ART. NR./CODE	INFO	W	V DC	V AC	LxBxH/LxWxH	FARBE/COLOUR	CHF
711-24752dt8	Konverter für Stripes, dimmbar DALI DT8 Push Dimm. 2 KANAL/ driver for Stripes, dimmable DALI DT8 Push dimm. 2 CHANNEL	75	24	230	486 x 31 x 31	<input type="checkbox"/> graphite	221,16





KONVERTER DALI PUSH/DRIVER DALI PUSH

ART. NR./CODE	INFO	W	V DC	V AC	LxBxH/LxWxH	FARBE/COLOUR	CHF
711-24302dt6	Konverter für Stripes, dimmbar DALI Push Dimm. 2 KANAL/ driver for Stripes, dimmable DALI Push dimm. 2 CHANNEL	30	24	230	170 x 54 x 54	□ white	116,88



DALI REPEATER SO DALI STEUERGERÄT/DALI REPEATER SO DALI CONTROLLER



ART. NR./CODE	INFO	LxBxH/LxWxH	CHF
28-292599	DALI Signalverstärker (Repeater); Erweiterung von DALI Anlagen um jeweils 64 EVG, die an den Repeater angeschlossenen EVG arbeiten als Gruppe Touch DIM Steuerung von jeweils 64 DALI EVG (ohne integrierten Lastkontakt) für Leuchteneinbau/ DALI signal amplifier (repeater); Extension of DALI systems by 64 ECGs each; The ECGs connected to the repeater operate as a group Touch DIM control of 64 DALI ECGs each (without integrated load contact) for luminaire installation	189 x 30 x 21	270,72



DALI REPEATER SO DALI STEUERGERÄT/DALI REPEATER SO DALI CONTROLLER



ART. NR./CODE	INFO	LxBxH/LxWxH	CHF
28-301093	DALI-Signalverstärker / Steuergerät mit TOUCH-DIMM, Eingang für max. 64 DALI EVG, Ansteuerung mit jedem handelsüblichen Taster, der DALI-Ausgang erlaubt die Ansteuerung von OSRAM fremden DALI-EVG's (Philips, Tridonic usw.), mit TOUCH-DIMM Funktion, 230V, 50-60Hz/ DALI signal amplifier / control unit with TOUCH-DIMM, input for max. 64 DALI ECGs, control with any commercially available pushbutton, the DALI output allows control of third-party OSRAM DALI ECGs (Philips, Tridonic etc.), with TOUCH-DIMM function, 230V, 50-60Hz	72 x 96 x 62	325,32



IP20

DALI MCU TW G2 STEUERGERÄT/DALI MCU TW G2 CONTROLLER



ART. NR./CODE	INFO	LxBxH/LxWxH	BLENDE B x H/COVER W x H	CHF
28-224673	<p>DALI MCU Drehregler für max. 25 DALI EVG's, ermöglicht manuelles Dimmen über DALI und Steuerung der Farbtemperatur mittels DALI DT8 tunable white, bis zu 4 DALI MCU sind parallel verwendbar, Kompatibel mit Abdeckungen von Jung, Berker, Siemens, Gira und Schneider Electric - für genauere Informationen benutzen Sie bitte den aktuellen OSRAM Katalog oder Montageanleitung, 230V / 50-60Hz, inkl. Blende (81x81mm) cremeweiß/ DALI MCU rotary controller for max. 25 DALI ECGs, enables manual dimming via DALI and control of colour temperature via DALI DT8 tunable white, up to 4 DALI MCU can be used in parallel, compatible with covers from Jung, Berker, Siemens, Gira and Schneider Electric - for more detailed information please use the current OSRAM catalogue or installation instructions, 230V / 50-60Hz, incl. cover (81x81mm) cream white</p>	71 x 71 x 50	81 x 81	183,00



IP20

DALI PCU STEUERGERÄT/DALI PCU CONTROLLER



ART. NR./CODE	INFO	LxBxH/LxWxH	CHF
28-631625	<p>DALI PCU Steuergerät (Eingang Taster / Ausgang DALI für 25 DALI Geräte) für Einbau in UP-Dose/ DALI PCU controller (input pushbutton / output DALI for 25 DALI units) for installation in flush-mounted box</p>	49 x 48 x 22	208,80



IP20

DALIECO CONTROL STEUERGERÄT/DALIECO CONTROL CONTROLLER



ART. NR./CODE	INFO	LxBxH/LxWxH	CHF
28-988645	<p>2-Kanal-Lichtsteuergerät mit DALI-Schnittstelle; Anschluss für bis zu 32 elektronische Vorschaltgeräte möglich 2-CHANNEL-lightcontroller with DALI interface; connection for up to 32 electronic ballasts possible Outputs with electronic reversible overtemperature, short-circuit and overload protection</p>	118 x 30 x 21	82,56

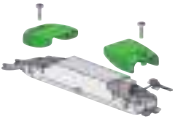

IP20

DALIECO CI KIT/DALIECO CI KIT



ART. NR./CODE	INFO	CHF
28-392091	Zugentlastungskit für DALIECO CONTROL Steuergerät notwendig bei externer Montage von Steuergerät DALICO CONTROL (Deckeneinbau)/ Strain relief kit for DALIECO controller required for external mounting of controller DALICO control (ceiling mounting)	21,60



IP20

DALIECO LS PD LI/DALIECO LS PD LI



ART. NR./CODE	INFO	L x B x H / L x W x H	CHF
28-988645	Licht- & Präsenzsensoren für Arbeitsplätze; Präsenzerfassung über passives IR-Element, Präsenzerfassungsbereich über integrierte Shutter zwischen 40...90° einstellbar, Funktionsanzeige mit zweifarbiger, Integrierter Infrarot-Fernbedienungs-Empfänger; maximale Installationshöhe 5m, für externe Montage Zubehör separat bestellen/ Light & Presence Sensor for Workplaces Presence detection via passive IR element, presence detection range via integrated shutter between 40...90° Adjustable, radiation display with two-colour, integrated infrared remote control receiver; maximum installation height 5m, for external mounting order accessories separately	48 x 15 x 17	82,56

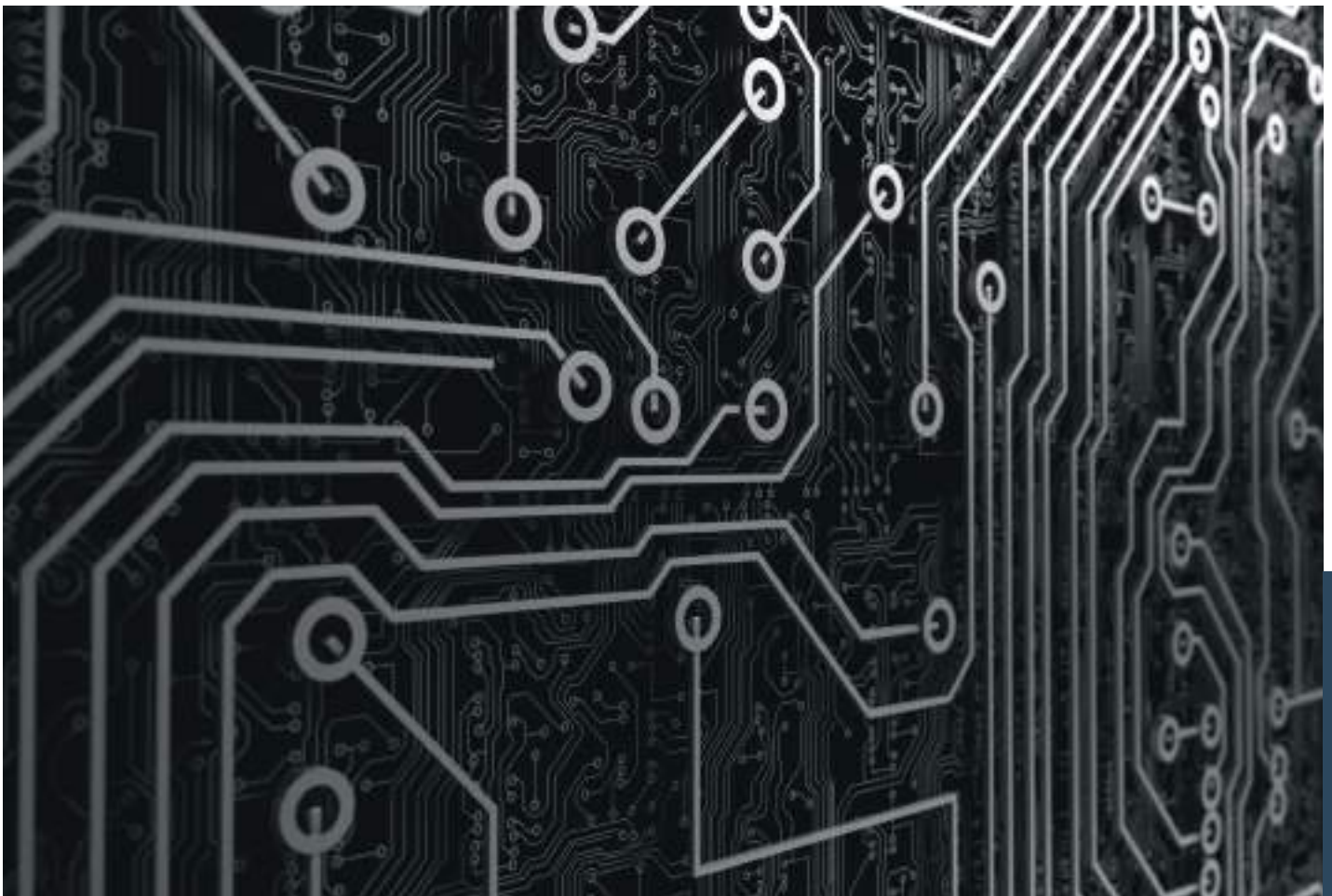



DALIECO DECKENEINBAUADAPTER/DALIECO CEILING MOUNTING ADAPTER



ART. NR./CODE	INFO	LxBxH/LxWxH	CHF
28-920293	Deckeneinbauadapter für DALIECO Sensoren [LS/PD]/ Ceiling installation adapter for DALIECO sensors [LS/PD]	80 x 36 x 68	54,60

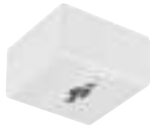

DALIECO DECKENAUFBAUGEHÄUSE/DALIECO CEILING MOUNTING HOUSING



ART. NR./CODE	INFO	LxBxH/LxWxH	CHF
28-173385	Aufbaugehäuse für DALIECO Sensoren [LS/PD]/ Surface-mounted housing for DALIECO sensors [LS/PD]	65 x 65 x 34	63,60



DALIECO REMOTE KIT MASTER/DALIECO REMOTE KIT MASTER



ART. NR./CODE	INFO	LxBxH/LxWxH	CHF
28-195967	Fernbedienung [Master] für die Konfiguration und Inbetriebnahme des DALIECO Lichtsteuerungssystems; Digitale IR-Übertragung mit Reichweite bis 10m, s zur Anzeige von Betriebs- und Programmiermodus und Signalübertragung, mit PC-Schnittstelle; im Lieferprogramm sind enthalten: Fernbedienung, 2 Stück Knopfzellen Typ CR2032, USB Verbindungskabel, DALIECO PC Software/ Remote control [Master] for configuration and commissioning of the DALIECO lighting control system; digital IR transmission with range up to 10m, s for display of operating and programming mode and signal transmission, with PC interface; included in delivery: Remote control, 2 button cells type CR2032, USB connection cable, DALIECO PC software.	230 x 45 x 13	247,80



DMX RGBW DIMMER/DMX RGBW DIMMER



ART. NR./CODE	INFO	V DC	LxBxH/LxWxH	FARBE/COLOUR	CHF
711-000705	RGBW Dimmer 12-36V DMX, 12V - 36V DC, geeignet zur Steuerung von RGBW Stripes, max. 5A / Kanal/ RGBW dimmer 12-36V DMX, 12V - 36V DC, suitable for controlling RGBW strips, max. 5A / channel	12-36	178 x 46 x 19	<input type="checkbox"/> white	155,04



UNIVERSALDIMMER/UNIVERSALDIMMER



ART. NR./CODE	INFO	V DC	LxBxH/LxWxH	FARBE/COLOUR	CHF
322-ud3000	Universaldimmer 1 Kanal, separater Steuereingang für DALI, 1-10V , Push, Sync Anschluß für bis zu 9 Slaves bei 1-10V oder Push Ansteuerung, max. Anschluß: 5A Zugentlastung separat ordern ZUGENTLASTUNG für 1-Kanal Universaldimmer, 2 Stück/ Universal dimmer 1 channel, separate control input for DALI, 1-10V , Push, Sync connection for up to 9 slaves with 1-10V or Push control, max. connection: 5A Strain relief to be ordered separately	15-50	153 x 30 x 21	<input type="checkbox"/> white	147,60 15,24
322-ud7001	Universal dimmer 1 channel, separate control input for DALI, 1-10V , Push, Sync connection for up to 9 slaves with 1-10V or Push control, max. connection: 5A Strain relief to be ordered separately STAIN RELIEF for 1-channel universaldimmer, 2 pcs.				



DALI DT8 PUSH DIMMER - 4 KANAL/DALI DT8 PUSH DIMMER - 4 CHANNEL



ART. NR./CODE	INFO	W	V DC	V AC	L x B x H/L x W x H	FARBE/COLOUR	CHF
711-24180dt8	Dimmer für Stripes, DALI DT8 für RGB/W, Konverter separat ordern/ Dimmer for Stripes, DALI DT8 for RGB/W, order driver separately	60-180	12-36	230	170 x 54 x 28	<input type="checkbox"/> white	204,60



LICHTSZENEKONTROLLER DALI/LIGHT SCENE CONTROLLER DALI

DALI DT8 RGBW - TOUCHPANEL/DALI DT8 RGBW - TOUCHPANEL



ART. NR./CODE	INFO	V AC	L x B x H/L x W x H	FARBE/COLOUR	CHF
711-01230d8rgbw	Lichtszenecontroller DALI DT8 für RGB/W Stripes, 4 Szenen konfigurierbar, zur Montage in Standard-Einbaudose Ø 68mm/ DALI DT8 light scene controller for RGB/W strips, 4 scenes configurable, for mounting in standard recessed box Ø 68mm	230	86 x 86 x 41	<input type="checkbox"/> white	213,48



DALI DT8 TUNABLE WHITE - TOUCHPANEL/DALI DT8 TUNABLE WHITE - TOUCHPANEL



ART. NR./CODE	INFO	V AC	L x B x H/L x W x H	FARBE/COLOUR	CHF
711-01230d8tw	Lichtszenecontroller DALI DT8 für tunable white Stripes, 4 Szenen konfigurierbar, zur Montage in Standard-Einbaudose Ø 68mm/ DALI DT8 light scene controller for tunable white strips, 4 scenes configurable, for mounting in standard recessed box Ø 68mm	230	86 x 86 x 41	<input type="checkbox"/> white	213,48

FUNK-STEUERUNG/RADIO CONTROLLER

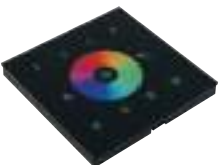

LICHTSZENEKONTROLLER - TOUCHPANEL/LIGHT SCENES CONTROLLER



ART. NR./CODE	INFO	FÜR/FOR	V DC	B x H x T/W x H x D	FARBE/COLOUR	CHF
711-000806	RGBW Funk Controller für bis zu 4 Zonen, bis zu 4 Stimmungen, Geschwindigkeit und Helligkeit kann angepasst werden, Steuereinheit kann auf Standard EB-Dose 68mm montiert werden/ RGBW radio controller for up to 4 zones, up to 4 moods, speed and brightness can be adjusted, control unit can be mounted on standard EB box 68mm	DMX	12-24	86 x 86 x 10	<input type="checkbox"/> black	212,28
711-000606		WIFI/FUNK/RADIO	12-24	86 x 86 x 10	<input type="checkbox"/> black	176,64



WLAN GATEWAY/WLAN GATEWAY



ART. NR./CODE	INFO	VDC	B x H x T/W x H x D	FARBE/COLOUR	CHF
711-000406	WLAN Gateway, zur Ansteuerung von 711-000305, dazugehöriges App. EASYColor Pro im Appstore bzw. Playstore kostenlos erhältlich, Integration in hauseigenes WLAN möglich/ WLAN gateway, for controlling 711-000305, associated app. EASYColor Pro available free of charge in the Appstore or Playstore, integration into the in-house WLAN possible.	12-24	110 x 85 x 24,2	■ black	155,04



RGB FUNKDIMMERFUNK FERNBEDIENUNG/RGBW RADIO DIMMER



ART. NR./CODE	INFO	W	VDC	L x B x H/L x W x H	FARBE/COLOUR	CHF
711-000305	4-Kanal Funk Dimmer zur Ansteuerung von RGBW, RGB oder weißen Stripes max. 5A/Kanal, Spannungsversorgung separat ordern/ 4-channel radio dimmer for controlling RGBW, RGB or white strips max. 5A/CHANNEL, order power supply separately	240-720	12-36	140 x 48 x 16	□ white	194,40



FUNK FERNBEDIENUNG/RADIO REMOTE CONTROL



ART. NR./CODE	INFO	L x B x H/L x W x H	FARBE/COLOUR	CHF
711-000506	Funk Fernbedienung für bis zu 4 Zonen, bis zu 4 Stimmungen, Geschwindigkeit und Helligkeit kann angepasst werden, inkl. Wandhalterung/ Radio remote control for up to 4 zones, up to 4 moods, speed and brightness can be adjusted, incl. wall bracket	140 x 48 x 16	■ black	199,56



FUNK FERNBEDIENUNG/RADIO REMOTE CONTROL



ART. NR./CODE	INFO	L x B x H/L x W x H	FARBE/COLOUR	CHF
711-001106	Funk Fernbedienung mit Farbrad zur einfachen Tunable White Steuerung, 2 Lichtfarben können gespeichert werden, 2 Szenen-Wahl, Dimmstufen in 25% Schritten abrufbar/ Radio remote control with colour wheel for easy tunable white control, 2 light colours can be stored, 2 scene selection, dimming levels can be called up in 25% steps	120 x 48 x 18	□ white	63,60



FUNK FERNBEDIENUNG/RADIO REMOTE CONTROL



ART. NR./CODE	INFO	L x B x H/L x W x H	FARBE/COLOUR	CHF
711-000906	Funk Fernbedienung für bis zu 5 Zonen zur Dimmung der Helligkeit, Fernbedienung kann mit bis zu 8 verschiedenen Empfängern arbeiten/ Radio remote control for up to 5 zones for dimming the brightness, remote control can work with up to 8 different receivers	136 x 39 x 11	■ black	57,24



FUNK DIMMER TUNABLE WHITE/RADIO DIMMER TUNABLE WHITE



ART. NR./CODE	INFO	W	V DC	L x B x H/L x W x H	FARBE/COLOUR	CHF
711-001005	2-Kanal Funk Dimmer zur Ansteuerung von Tunable White Stripes max. 5A/Kanal, Spannungsversorgung separat ordern/ 2-channel radio dimmer for controlling Tunable White LED strips max. 5A/channel, order power supply separately	110-240	12-24	145 x 47 x 16	<input type="checkbox"/> white	72,48



BLUETOOTHSTEUERUNG/BLUETOOTH CONTROLLER

PUSH BUTTON INTERFACE/PUSH BUTTON INTERFACE



ART. NR./CODE	INFO	V AC	L x B x H/L x W x H	FARBE/COLOUR	CHF
701-1005	Zur Integration von handelsüblichen Tastern in die MOLTO LUCE Smart App BLUETOOTH Dimm., 3 Kanal UP-Dosenmodul/ For integrating commercially available push-buttons into the MOLTO LUCE Smart App., BLUETOOTH Dimm., 3 channel flush-mounted box module.	230	43 x 43 x 18	<input checked="" type="checkbox"/> blue	133,44



BLUETOOTH DIMMER-2 KANAL/BLUETOOTH DIMMER-2 CHANNEL



ART. NR./CODE	INFO	W	V DC OUT	L x B x H/L x W x H	FARBE/COLOUR	CHF
701-1004	SED DCC 2CH BLL Konverter, PWM-dimmbar, Draht Querschnitt bis zu 2,5mm, Schutz gegen Überhitzung und Kurzschluss, Netzüber- spannungen, Überlast, Deckeneinlegeausschnitt=40mm, I out = 4,5A max./ SED DCC 2CH BLL converter, PWM-dimmable, wire cross-section up to 2,5mm, protection against overheating and short-circuit, mains overvoltage, overload, ceiling cut-out=40mm, I out = 4.5A max.	2x 55 1x 110	2x 24	115 x 34 x 19	<input checked="" type="checkbox"/> blue	110,52



INTERFACE SMART BLUETOOTH TO DALI/INTERFACE SMART BLUETOOTH TO DALI



ART. NR./CODE	INFO	V AC	L x B x H/L x W x H	FARBE/COLOUR	CHF
701-1003	Zur Integration von max. 40 Dali dimmbaren Leuchte in die MOLTO LUCE Smart App, BLUETOOTH Dimm., Smart BLUETOOTH to DALI/ For integration of max. 40 Dali dimmable luminaires in the MOLTO LUCE Smart App, BLUETOOTH Dimm., Smart BLUETOOTH to DALI	230	85 x 30 x 22	<input checked="" type="checkbox"/> blue	97,80

MOLTO LUCE SMART APP/MOLTO LUCE SMART APP



INFO

Die Molto Luce Smart APP ist ihr System zur Lichtsteuerung, egal ob einzelne Gruppen, ganze Netzwerke, Szenen, Zeitsteuerungen und komplexe Lösungen wie Heatmapping. Die Molto Luce Smart APP stellt Ihnen alle Möglichkeiten zur Verfügung. **DOWNLOAD IM APP ODER PLAY STORE/**

The Molto Luce Smart APP is your system for lighting control, whether individual groups, entire networks, scenes, time controls and complex solutions such as heat mapping. The Molto Luce Smart APP provides you with all possibilities. **DOWNLOAD IN APP OR PLAY STORE**



SMART APP BEDIENUNGSANLEITUNG:
SMART APP INSTRUCTION MANUAL:





ELEKTRONISCHER TRANSFORMATOR/ELECTRONIC TRANSFORMER

ART. NR./CODE	INFO	W	L x B x H/ID x L x W x H	FARBE/COLOUR	CHF
24-119654	Elektronischer Transformator, weiß, dimmbar mit Phasen-/abschnittdimmer, thermisch progressive Sicherung (NTC), gesichert gegen Kurzschluß und Überlast auf Sekundärseite, automatische Wiederherstellung, elektromagnetische Verträglichkeit, Funkenstörfilter gem. EN55014/5, Transformatorbefestigung durch Ösen und Schrauben, Klemmabdeckung mit integrierter Zugentlastung, primär 2,5mm ² , sekundär bis 2,5mm ² (60-105VA), bzw. bis 6mm ² (150VA), * nur Phasenabschnitt dimmbar (210 und 250VA)/	10-60	94 x 31 x 20	<input type="checkbox"/> white	19,08
24-119730	electronic transformer, white, dimmable with leading edge / trailing edge, thermal progressive fuse (NTC), protections against short circuits and against overloads on secondary side; automatic recovery, electromagnetic compatibility, radio interference filter according to EN55014/5, transformer fixing by eyelets and screws, terminal cover with integrated strain relief, primary 2,5mm ² , secondary up to 2,5mm ² (60-105VA) respectively up to 6mm ² (150VA), only trailing edge dimmable (210 and 250VA)	20-105	128 x 38 x 28	<input type="checkbox"/> white	20,28
24-119851u		30-150	166 x 47 x 35	<input type="checkbox"/> white	36,84



ELEKTRONISCHER TRANSFORMATOR/ELECTRONIC TRANSFORMER

ART. NR./CODE	INFO	W	L x B x H/ID x L x W x H	FARBE/COLOUR	CHF
75-pr105	Elektronischer Transformator, schwarz, vergossen, dimmbar mit Phasenabschnittdimmer, thermisch progressive Sicherung gesichert gegen Kurzschluß und Überlast auf Sekundärseite, elektromagnetische Verträglichkeit, Funkenstörfilter gem. EN55014/5, Anschluß mit Litzekabel Länge 200mm, Primärleitung 2x 0,75mm ² doppelt isoliert, Sekundärleitung 2x 0,75mm ² , Umgebungstemperatur -10° bis +40°/ electronic transformer, black, spilled, dimmable with trailing edge, thermal progressive fuse (NTC), protections against short circuits and against overloads on secondary side; electromagnetic compatibility, radio interference filter according to EN55014/5, connection with stranded wire length 200mm, primary line 2x 0,75mm ² , double isolated, secondary line 2x 0,75mm ² , ambient temperature -10° up to +40°	20-105	134 x 30 x 21	<input checked="" type="checkbox"/> black	31,80



ELEKTRONISCHER TRANSFORMATOR/ELECTRONIC TRANSFORMER

ART. NR./CODE	INFO	W	Ø x H/Ø x H	FARBE/COLOUR	CHF
24-119640	Elektronischer Transformator, weiß, rund, dimmbar mit Phasen-/ abschnittdimmer, thermisch progressive Sicherung (NTC) gesichert gegen Kurzschluß und Überlast auf Sekundärseite, Wederherstellung automatisch, elektromagnetische Verträglichkeit, Funkenstörfilter gem. EN55014/5, Ausgangsspannung 12V/	20-60	53 x 19	<input type="checkbox"/> white	21,60
24-119618	electronic transformer, white, round, dimmable with leading edge / trailing edge, thermal progressive fuse (NTC), protections against short circuits and against overloads on secondary side; automatic recovery, electromagnetic compatibility, radio interference filter according to EN55014/5, output voltage 12V	20-105	70 x 22	<input type="checkbox"/> white	31,80



KONVERTER STM U / DRIVER STM U

ART. NR./CODE	INFO	W	mA	V DC	L x B x H / L x W x H	FARBE / COLOUR	CHF
24-127719	nicht dimmbar, 230V / not dimmable, 230V	6	250	23	42 x 40 x 22	■ black	23,76
24-127715		8	350	23	42 x 40 x 22	■ black	23,76
24-127717		6	500	9	42 x 40 x 22	■ black	23,76
24-127718		6	700	12	42 x 40 x 22	■ black	23,76



KONVERTER BULL U / DRIVER BULL U

ART. NR./CODE	INFO	W	mA	V DC	L x B x H / L x W x H	FARBE / COLOUR	CHF
24-141133	nicht dimmbar, 230V AC / not dimmable, 230V AC	9	250	36	60 x 35 x 21,5	□ white	27,96
24-141130		4	350	12	60 x 35 x 21,5	□ white	25,20
24-141132		8	350	22	60 x 35 x 21,5	□ white	25,20
24-141131		6	500	12	60 x 35 x 21,5	□ white	26,52



KONVERTER STC U / DRIVER STC U

ART. NR./CODE	INFO	W	mA	V DC	L x B x H / L x W x H	FARBE / COLOUR	CHF
24-141050	nicht dimmbar, 230V AC / not dimmable, 230V AC	8	350	23	51 x 31 x 21	■ black	21,00
24-141054		6	500	12	51 x 31 x 21	■ black	21,00



KONVERTER SLIM U / DRIVER SLIM U

ART. NR./CODE	INFO	W	mA	V DC	L x B x H / L x W x H	FARBE / COLOUR	CHF
24-141110	nicht dimmbar, 230V AC / not dimmable, 230V AC	15	350	43	142 x 22 x 19	□ white	33,60



KONVERTER PMR / DRIVER PMR

ART. NR./CODE	INFO	W	mA	V DC	Ø x H / Ø x H	FARBE / COLOUR	CHF
75-pmr12	nicht dimmbar, 230V AC / not dimmable, 230V AC	8	700	12	53 x 19	□ white	25,44



KONVERTER PMR/DRIVER PMR

ART. NR./CODE	INFO	W	mA	V DC	L x B x H/L x W x H	FARBE/COLOUR	CHF
75-mp11	nicht dimmbar, 230V AC/ not dimmable, 230V AC	1	350	6	51 x 32 x 18	■ black	21,60
75-mp13		4	350	12	51 x 32 x 18	■ black	21,60
75-mp14		2	700	6	51 x 32 x 18	■ black	21,60
75-mp15		4	500	9	51 x 32 x 18	■ black	21,60



KONVERTER STPM U IP54/DRIVER STPM U 54

ART. NR./CODE	INFO	W	mA	V DC	L x B x H/L x W x H	FARBE/COLOUR	CHF
24-127703	nicht dimmbar, 230V AC/ not dimmable, 230V AC	8	350	23	44 x 46 x 26,5	■ black	38,52
24-127705		8	500	12	44 x 46 x 26,5	■ black	38,52
24-127701		6	700	12	44 x 46 x 26,5	■ black	38,52



NEW



KONVERTER MOLTO LUCE/DRIVER MOLTO LUCE

ART. NR./CODE	INFO	W	mA	V DC	L x B x H/L x W x H	FARBE/COLOUR	CHF		
877-BKPSL012LA0300AS	Konverter, nicht dimmbar, 230V AC, doppelter Anschlussblock für Durchgangsverdrahtung/ driver, non-dimmable, 230V AC, double terminal block for through-wiring Einstellbar mittels/Adjustable with DIP-Switch:	8-12	200-300	28-42	157,5 x 48 x 30	▣ grey/white	30,00		
	mA							W	V DC
	200							8	28-42
	250							10	28-42
	300	12	28-42						



NEW



KONVERTER MOLTO LUCE/DRIVER MOLTO LUCE

ART. NR./CODE	INFO	W	mA	V DC	L x B x H/L x W x H	FARBE/COLOUR	CHF		
877-BKPSL022LA0500AS	Konverter, nicht dimmbar, 230V AC, doppelter Anschlussblock für Durchgangsverdrahtung/ driver, non-dimmable, 230V AC, double terminal block for through-wiring Einstellbar mittels/Adjustable with DIP-Switch:	12 - 21	300 - 500	28-42	157,5 x 48 x 30	▣ grey/white	30,00		
	mA							W	V DC
	300							12	28-42
	350							14	28-42
	400							16	28-42
	450							18	28-42
500	21	28-42							



NEW



KONVERTER XITANIUM MINI 20W/DRIVER XITANIUM MINI 20W

ART. NR./CODE	INFO	W	mA	V DC	L x B x H/L x W x H	FARBE/COLOUR	CHF
30-880006	Konverter, nicht dimmbar, 230V AC, doppelter Anschlussblock für Durchgangsverdrahtung/ driver, non-dimmable, 230V AC, double terminal block for through-wiring Einstellbar mittels/Adjustable with DIP-Switch:	6-20	150-500	5-44	156 x 43 x 30	<input type="checkbox"/> white	15,60
	mA	W	V DC				
	150	6	5-44				
	200	8,5	5-44				
	250	11	5-44				
	300	13	5-44				
	350	15	5-44				
	400	17,5	5-44				
	450	20	5-44				
	500	18,5	5-37				

NEW



KONVERTER XITANIUM MINI 30W/DRIVER XITANIUM MINI 30W

ART. NR./CODE	INFO	W	mA	V DC	L x B x H/L x W x H	FARBE/COLOUR	CHF
30-880106	Konverter, nicht dimmbar, 230V AC, doppelter Anschlussblock für Durchgangsverdrahtung/ driver, non-dimmable, 230V AC, double terminal block for through-wiring Einstellbar mittels/Adjustable with DIP-Switch:	9-30	350-700	5-44	156 x 43 x 30	<input type="checkbox"/> white	16,80
	mA	W	V DC				
	350	15	5-44				
	400	17	5-44				
	450	19	5-44				
	500	22	5-44				
	550	24	5-44				
	600	26	5-44				
	650	28	5-44				
	700	30	5-44				

NEW



KONVERTER XITANIUM MINI 40W/DRIVER XITANIUM MINI 40W

ART. NR./CODE	INFO	W	mA	V DC	L x B x H/L x W x H	FARBE/COLOUR	CHF
30-880206	Konverter, nicht dimmbar, 230V AC, doppelter Anschlussblock für Durchgangsverdrahtung/ driver, non-dimmable, 230V AC, double terminal block for through-wiring Einstellbar mittels/Adjustable with DIP-Switch:	12 - 40	700 - 1050	5-44	156 x 43 x 30	<input type="checkbox"/> white	18,00
	mA	W	V DC				
	700	30	5-44				
	750	33	5-44				
	800	35	5-44				
	850	37	5-44				
	900	39	5-44				
	950	40	5-44				
	1000	40	5-40				
	1050	40	5-38				

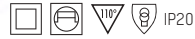

KONSTANTSTROM KONVERTER/CONSTANT CURRENT DRIVER

KONVERTER PROFESSIONALE IN 52/DRIVER PROFESSIONALE IN 52

ART. NR./CODE	INFO	W	mA	V DC	L x B x H/L x W x H	FARBE/COLOUR	CHF																																																						
24-127483	nicht dimmbar, 230V AC, doppelter Anschlussblock für Durchgangsverdrahtung/ not dimmable, 230V AC, Double terminal block for through-wiring Einstellbar mittels/Adjustable with DIP-Switch:	27,3-52	650-1400	42-37,5	132 x 79 x 30	■ grey	77,52																																																						
	<table border="1"> <thead> <tr> <th>mA</th> <th>W</th> <th>V DC</th> <th>mA</th> <th>W</th> <th>V DC</th> </tr> </thead> <tbody> <tr> <td>650</td> <td>27,3</td> <td>42</td> <td>1050</td> <td>42</td> <td>40</td> </tr> <tr> <td>700</td> <td>29,4</td> <td>42</td> <td>1100</td> <td>42,9</td> <td>39</td> </tr> <tr> <td>750</td> <td>30,7</td> <td>41</td> <td>1150</td> <td>44,8</td> <td>39</td> </tr> <tr> <td>800</td> <td>32,8</td> <td>41</td> <td>1200</td> <td>46,8</td> <td>39</td> </tr> <tr> <td>850</td> <td>34,8</td> <td>41</td> <td>1250</td> <td>47,5</td> <td>38</td> </tr> <tr> <td>900</td> <td>36</td> <td>40</td> <td>1300</td> <td>49,4</td> <td>38</td> </tr> <tr> <td>950</td> <td>38</td> <td>40</td> <td>1350</td> <td>51,3</td> <td>38</td> </tr> <tr> <td>1000</td> <td>40</td> <td>40</td> <td>1400</td> <td>52</td> <td>37,5</td> </tr> </tbody> </table>	mA	W	V DC	mA	W	V DC	650	27,3	42	1050	42	40	700	29,4	42	1100	42,9	39	750	30,7	41	1150	44,8	39	800	32,8	41	1200	46,8	39	850	34,8	41	1250	47,5	38	900	36	40	1300	49,4	38	950	38	40	1350	51,3	38	1000	40	40	1400	52	37,5						
mA	W	V DC	mA	W	V DC																																																								
650	27,3	42	1050	42	40																																																								
700	29,4	42	1100	42,9	39																																																								
750	30,7	41	1150	44,8	39																																																								
800	32,8	41	1200	46,8	39																																																								
850	34,8	41	1250	47,5	38																																																								
900	36	40	1300	49,4	38																																																								
950	38	40	1350	51,3	38																																																								
1000	40	40	1400	52	37,5																																																								

KONVERTER MP 50 K3/DRIVER MP 50 K3

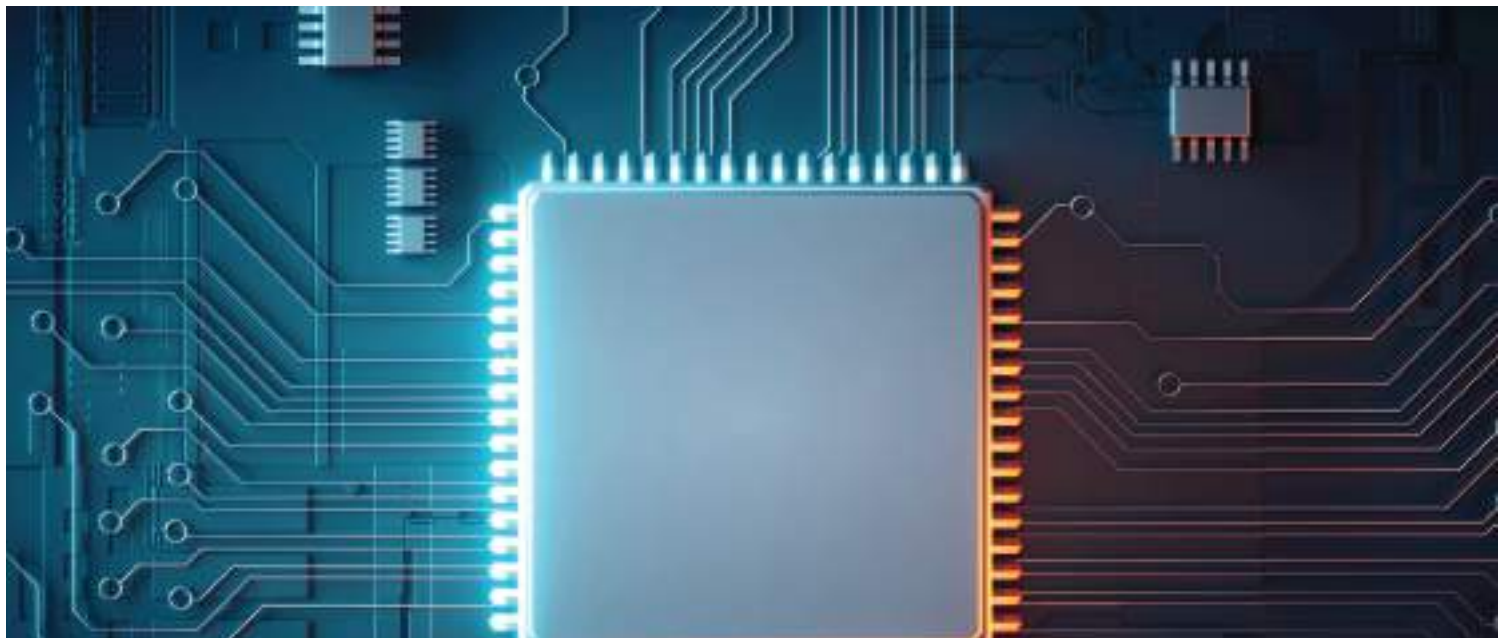
ART. NR./CODE	INFO	W	mA	V DC	L x B x H/L x W x H	FARBE/COLOUR	CHF																																				
24-122204	nicht dimmbar, 230V AC/ not dimmable, 230V AC Einstellbar mittels/Adjustable with DIP-Switch:	25-50	350-1050	74-48	124 x 79 x 22	□ white	72,48																																				
	<table border="1"> <thead> <tr> <th>mA</th> <th>W</th> <th>V DC</th> <th>mA</th> <th>W</th> <th>V DC</th> </tr> </thead> <tbody> <tr> <td>350</td> <td>25</td> <td>74</td> <td>750</td> <td>50</td> <td>66</td> </tr> <tr> <td>500</td> <td>35</td> <td>72</td> <td>850</td> <td>50</td> <td>58</td> </tr> <tr> <td>550</td> <td>39</td> <td>72</td> <td>900</td> <td>50</td> <td>55</td> </tr> <tr> <td>650</td> <td>46</td> <td>72</td> <td>1050</td> <td>50</td> <td>48</td> </tr> <tr> <td>700</td> <td>50</td> <td>71</td> <td></td> <td></td> <td></td> </tr> </tbody> </table>	mA	W	V DC	mA	W	V DC	350	25	74	750	50	66	500	35	72	850	50	58	550	39	72	900	50	55	650	46	72	1050	50	48	700	50	71									
mA	W	V DC	mA	W	V DC																																						
350	25	74	750	50	66																																						
500	35	72	850	50	58																																						
550	39	72	900	50	55																																						
650	46	72	1050	50	48																																						
700	50	71																																									



KONSTANTSTROM KONVERTER DIMMBAR/CONSTANT CURRENT DRIVER DIMMABLE

KONVERTER MINI JOLLY 20/DRIVER MINI JOLLY 20

ART. NR./CODE	INFO	W	mA	V DC	L x B x H/L x W x H	FARBE/COLOUR	CHF
24-151400	Konverter, 1-10V & PUSH dimmbar, 230V AC/ driver, 1-10V & PUSH dimmable, 230V AC Einstellbar mittels/Adjustable with DIP-Switch: Konstantstrom/constant current	13-20	250-900	53-23	111 x 52 x 22	□ white	57,24
	mA W V DC mA W V DC						
	250 13 53 600 20 34						
	300 15 52 650 20 31						
	350 18 50 700 20 29						
	400 20 50 750 20 27						
	450 20 45 800 20 25						
	500 20 40 850 20 24						
550 20 37 900 20 23							

KONVERTER MINI JOLLY LC20/DRIVER MINI JOLLY LC20

ART. NR./CODE	INFO	W	mA	V DC	L x B x H/L x W x H	FARBE/COLOUR	CHF
24-151401	Konverter, 1-10V & PUSH dimmbar, 230V AC/ driver, 1-10V & PUSH dimmable, 230V AC Einstellbar mittels/Adjustable with DIP-Switch: Konstantstrom/constant current	5-20	100-380	54-52	111 x 52 x 22	□ white	58,44
	mA W V DC mA W V DC						
	100 5 54 260 14 53						
	120 6 54 280 15 53						
	140 7 53 300 16 52,5						
	160 8 53 320 17 52						
	180 9 53 340 18 52						
	200 10 53 360 19 52						
240 12 53 380 20 52							

KONVERTER MINI JOLLY DALI 20/DRIVER MINI JOLLY DALI 20

ART. NR./CODE	INFO	W	mA	V DC	L x B x H/L x W x H	FARBE/COLOUR	CHF
24-151403	Konverter, DALI dimmbar, 230V AC/ driver, DALI dimmable, 230V AC Einstellbar mittels/Adjustable with DIP-Switch: Konstantstrom/constant current	12-20	250-700	49-28	111 x 52 x 22	□ white	68,64
	mA W V DC mA W V DC						
	250 12 49 500 20 40						
	350 17 49 550 20 36						
	400 19 49 600 20 33						
450 20 45 700 20 28							



KONVERTER MINI JOLLY LC DALI/DRIVER MINI JOLLY LC DALI

ART. NR./CODE	INFO	W	mA	V DC	LxBxH/LxWxH	FARBE/COLOUR	CHF
24-151395	Konverter, DALI dimmbar, 230V AC/ driver, DALI dimmable, 230V AC Einstellbar mittels/Adjustable with DIP-Switch:	5-19	100-380	50	108 x 52 x 22	<input type="checkbox"/> white	69,84
	Konstantstrom/constant current						
	mA W V DC mA W V DC						
	100 5 50 260 13 50						
	140 7 50 300 15 50						
	180 9 50 340 17 50						
220 11 53 380 19 50							



KONVERTER PROFESSIONALE DALI 36/DRIVER PROFESSIONALE DALI 36

ART. NR./CODE	INFO	W	mA	V DC	LxBxH/LxWxH	FARBE/COLOUR	CHF
24-127490	Konverter, DALI dimmbar, 230V AC/ driver, DALI dimmable, 230V AC Einstellbar mittels/Adjustable with DIP-Switch:	16-38	300-1050	54-36	147 x 44 x 30	<input type="checkbox"/> white	81,36
	Konstantstrom/constant current						
	mA W V DC mA W V DC						
	300 16 54 700 38 54						
	350 18 54 750 38 51						
	400 21 54 800 38 48						
	450 24 54 850 38 45						
	500 27 54 900 38 42						
	550 29 54 950 38 40						
	600 32 54 1000 38 38						
650 35 54 1050 38 36							



KONVERTER MAXI JOLLY SV DALI 50/DRIVER MAXI JOLLY SV DALI 50

ART. NR./CODE	INFO	W	mA	V DC	LxBxH/LxWxH	FARBE/COLOUR	CHF
24-151504	Konverter, 1-10V PUSH & DALI dimmbar, 230V AC/ driver, 1-10V PUSH & DALI dimmable, 230V AC Einstellbar mittels/Adjustable with DIP-Switch:	18-50	350-1200	53-41	124 x 79 x 22	<input type="checkbox"/> white	96,60
	Konstantstrom/constant current						
	mA W V DC mA W V DC						
	350 18 53 800 39 53						
	400 21 53 850 42 53						
	450 23 53 900 45 53						
	500 2 53 950 47, 52						
	550 29 53 1000 50 50						
	600 31 53 1050 50 48						
	650 34 53 1100 50 45						
700 34 53 1150 50 43							
750 37 53 1200 50 41							

KONSTANTSTROM KONVERTER DIMMBAR/CONSTANT CURRENT DRIVER DIMMABLE

KONVERTER PROFESSIONALE IN DALI 20/DRIVER PROFESSIONALE IN DALI 20

ART. NR./CODE	INFO	W	mA	V DC	L x B x H/L x W x H	FARBE/COLOUR	CHF																																																						
24-127508	Konverter, PUSH & DALI dimmbar, 230V AC, doppelte Anschluss- und DALI-Klemmblöcke für Durchgangsverdrahtung/ driver, PUSH & DALI dimmable, 230V AC, double connection and DALI terminal blocks for through-wiring Einstellbar mittels/Adjustable with DIP-Switch:	6,5-20	125-500	54-40	132 x 79 x 30	■ grey	55,92																																																						
	<table border="1"> <thead> <tr> <th>mA</th> <th>W</th> <th>V DC</th> <th>mA</th> <th>W</th> <th>V DC</th> </tr> </thead> <tbody> <tr><td>125</td><td>6,5</td><td>54</td><td>325</td><td>17</td><td>54</td></tr> <tr><td>150</td><td>8</td><td>54</td><td>350</td><td>19</td><td>54</td></tr> <tr><td>175</td><td>9</td><td>54</td><td>375</td><td>20</td><td>54</td></tr> <tr><td>200</td><td>10</td><td>54</td><td>400</td><td>20</td><td>54</td></tr> <tr><td>225</td><td>12</td><td>54</td><td>425</td><td>20</td><td>47</td></tr> <tr><td>250</td><td>13</td><td>54</td><td>450</td><td>20</td><td>44</td></tr> <tr><td>275</td><td>14</td><td>54</td><td>475</td><td>20</td><td>42</td></tr> <tr><td>300</td><td>16</td><td>54</td><td>500</td><td>20</td><td>40</td></tr> </tbody> </table>	mA	W	V DC	mA	W	V DC	125	6,5	54	325	17	54	150	8	54	350	19	54	175	9	54	375	20	54	200	10	54	400	20	54	225	12	54	425	20	47	250	13	54	450	20	44	275	14	54	475	20	42	300	16	54	500	20	40						
mA	W	V DC	mA	W	V DC																																																								
125	6,5	54	325	17	54																																																								
150	8	54	350	19	54																																																								
175	9	54	375	20	54																																																								
200	10	54	400	20	54																																																								
225	12	54	425	20	47																																																								
250	13	54	450	20	44																																																								
275	14	54	475	20	42																																																								
300	16	54	500	20	40																																																								

KONVERTER PROFESSIONALE IN DALI 40/DRIVER PROFESSIONALE IN DALI 40

ART. NR./CODE	INFO	W	mA	V DC	L x B x H/L x W x H	FARBE/COLOUR	CHF																																																						
24-127481	Konverter, PUSH & DALI dimmbar, 230V AC, doppelte Anschluss- und DALI-Klemmblöcke für Durchgangsverdrahtung/ driver, PUSH & DALI dimmable, 230V AC, double connection and DALI terminal blocks for through-wiring Einstellbar mittels/Adjustable with DIP-Switch:	16-40	300-1050	54-38	132 x 80 x 30	■ grey	67,32																																																						
	<table border="1"> <thead> <tr> <th>mA</th> <th>W</th> <th>V DC</th> <th>mA</th> <th>W</th> <th>V DC</th> </tr> </thead> <tbody> <tr><td>300</td><td>16</td><td>54</td><td>700</td><td>38</td><td>54</td></tr> <tr><td>350</td><td>19</td><td>54</td><td>750</td><td>40</td><td>54</td></tr> <tr><td>400</td><td>21</td><td>54</td><td>800</td><td>40</td><td>50</td></tr> <tr><td>450</td><td>24</td><td>54</td><td>850</td><td>40</td><td>47</td></tr> <tr><td>500</td><td>27</td><td>54</td><td>900</td><td>40</td><td>45</td></tr> <tr><td>550</td><td>29</td><td>54</td><td>950</td><td>40</td><td>42</td></tr> <tr><td>600</td><td>32</td><td>54</td><td>1000</td><td>40</td><td>40</td></tr> <tr><td>650</td><td>35</td><td>54</td><td>1050</td><td>40</td><td>38</td></tr> </tbody> </table>	mA	W	V DC	mA	W	V DC	300	16	54	700	38	54	350	19	54	750	40	54	400	21	54	800	40	50	450	24	54	850	40	47	500	27	54	900	40	45	550	29	54	950	40	42	600	32	54	1000	40	40	650	35	54	1050	40	38						
mA	W	V DC	mA	W	V DC																																																								
300	16	54	700	38	54																																																								
350	19	54	750	40	54																																																								
400	21	54	800	40	50																																																								
450	24	54	850	40	47																																																								
500	27	54	900	40	45																																																								
550	29	54	950	40	42																																																								
600	32	54	1000	40	40																																																								
650	35	54	1050	40	38																																																								

KONVERTER MOLTO LUCE DALI/DRIVER MOLTO LUCE DALI

ART. NR./CODE	INFO	W	mA	V DC	L x B x H/L x W x H	FARBE/COLOUR	CHF																																																						
877-BKDDL030B0800ADP	Konverter, PUSH & DALI-2 dimmbar, 230V AC, doppelte Anschluss- und DALI-Klemmblöcke für Durchgangsverdrahtung/ Converter, PUSH & DALI-2 dimmable, 230V AC, double connection and DALI terminal blocks for through-wiring Einstellbar mittels/Adjustable with DIP-Switch:	10,50 - 33,50	250 - 800	6-42	172 x 57,5 x 30	■ blue/black	66,00																																																						
	<table border="1"> <thead> <tr> <th>mA</th> <th>W</th> <th>V DC</th> <th>mA</th> <th>W</th> <th>V DC</th> </tr> </thead> <tbody> <tr><td>250</td><td>10,5</td><td>6-42</td><td>450</td><td>18</td><td>6-42</td></tr> <tr><td>275</td><td>11</td><td>6-42</td><td>500</td><td>21</td><td>6-42</td></tr> <tr><td>300</td><td>12</td><td>6-42</td><td>550</td><td>23</td><td>6-42</td></tr> <tr><td>325</td><td>13</td><td>6-42</td><td>600</td><td>25</td><td>6-42</td></tr> <tr><td>350</td><td>14</td><td>6-42</td><td>650</td><td>27</td><td>6-42</td></tr> <tr><td>375</td><td>15</td><td>6-42</td><td>700</td><td>29</td><td>6-42</td></tr> <tr><td>400</td><td>16</td><td>6-42</td><td>750</td><td>31</td><td>6-42</td></tr> <tr><td>425</td><td>17</td><td>6-42</td><td>800</td><td>33,5</td><td>6-42</td></tr> </tbody> </table>	mA	W	V DC	mA	W	V DC	250	10,5	6-42	450	18	6-42	275	11	6-42	500	21	6-42	300	12	6-42	550	23	6-42	325	13	6-42	600	25	6-42	350	14	6-42	650	27	6-42	375	15	6-42	700	29	6-42	400	16	6-42	750	31	6-42	425	17	6-42	800	33,5	6-42						
mA	W	V DC	mA	W	V DC																																																								
250	10,5	6-42	450	18	6-42																																																								
275	11	6-42	500	21	6-42																																																								
300	12	6-42	550	23	6-42																																																								
325	13	6-42	600	25	6-42																																																								
350	14	6-42	650	27	6-42																																																								
375	15	6-42	700	29	6-42																																																								
400	16	6-42	750	31	6-42																																																								
425	17	6-42	800	33,5	6-42																																																								

**KONVERTER FÜR PANELLEUCHE FIT/DRIVER FOR PANEL LIGHT FIT**

ART. NR./CODE	INFO	AUSFÜHRUNG/EXECUTION	mA	Lx B x H/ Lx W x H	FARBE/COLOUR	CHF
757-k900s	Konverter 230V AC für Panelleuchte FIT, inkl. MOLEX Steckverbindung/ 230V AC converter for FIT panel light, incl. MOLEX plug connection	schaltbar/switchable	900	103 x 67 x 30	<input type="checkbox"/> white	38,16
757-k1200s		schaltbar/switchable	1200	130 x 43 x 30	<input type="checkbox"/> white	50,88
757-k900d		DALI dimmbar/dimmable	900	110 x 75 x 25	<input type="checkbox"/> white	105,48
757-k1200d		DALI dimmbar/dimmable	1200	171 x 81 x 30	<input type="checkbox"/> white	116,88

**SYNCHRONISATIONSKABEL FÜR MAXI JOLLY/SYNCHRONISATION CABLE FOR MAXI JOLLY**

ART. NR./CODE	INFO	L	FARBE/COLOUR	CHF
24-485720512	Für MAXI JOLLY Konverter/ For MAXI JOLLY driver	1500	<input type="checkbox"/> white	8,88

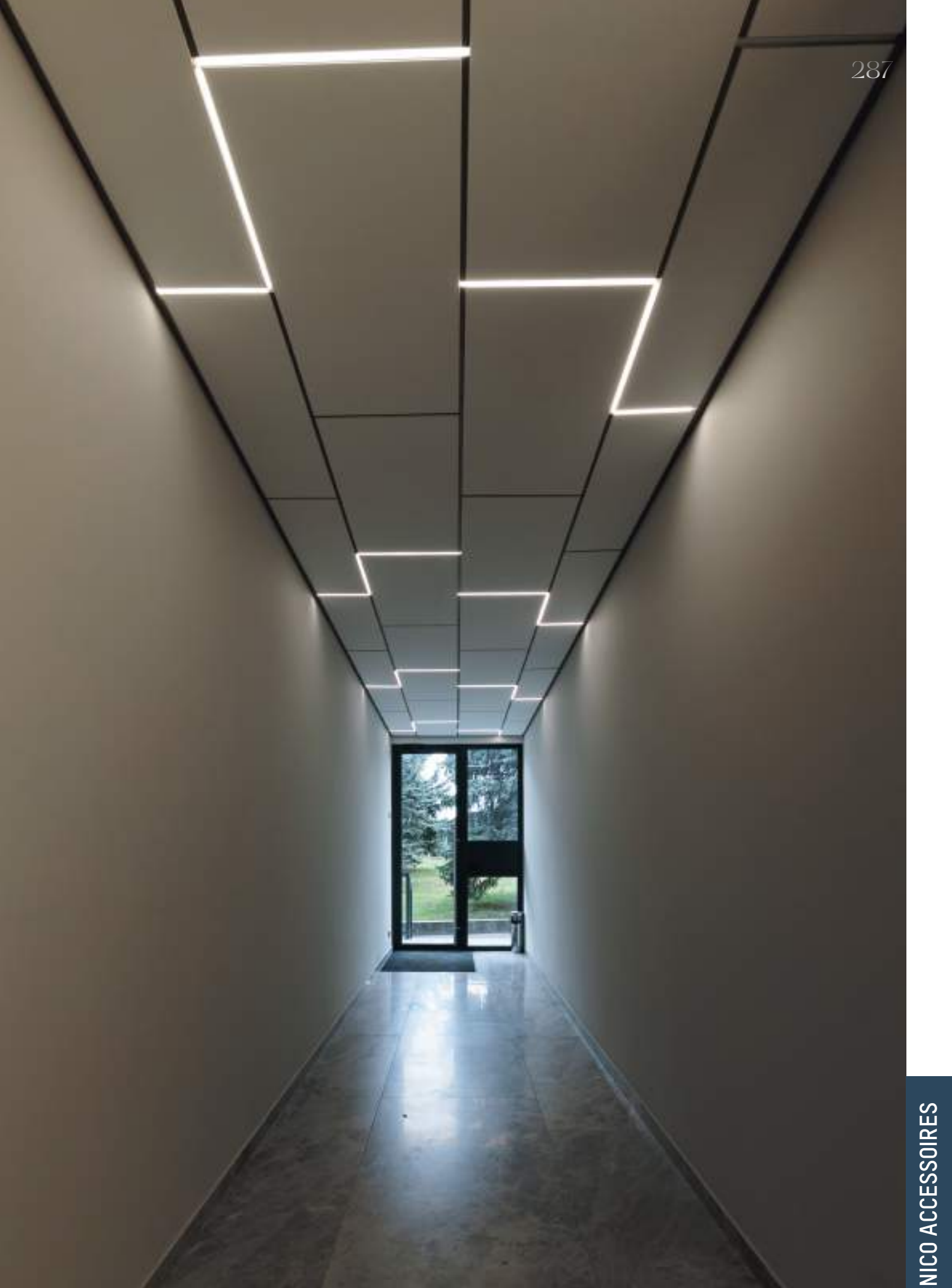



LEUCHTMITTEL
BULBS



LED RETROFIT/LED RETROFIT

ART. NR./CODE	INFO	FASSUNG/SOCKET	WATT	KELVIN	EEF	AUSSTRAHLUNGSWINKEL/BEAM ANGLE	CHF
30-347168	A60/CorePro LED Bulb clear	E27	4	2700		>300	5,52
30-380035	A60/CorePro LED Bulb clear		7	2700		>300	5,88
30-347960	ST64/MASTER VLE LED Bulb clear, dim.		6	2700		270	9,84
30-347984	G120/MASTER VLE LED Bulb clear		6	2700		>300	12,00
30-313781	G200/Classic LED Bulb gold, dim.		6,5	1800		>300	78,12



A60

LED RETROFIT/LED RETROFIT

ART. NR./CODE	INFO	FASSUNG/SOCKET	WATT	KELVIN	EEF	AUSSTRAHLUNGSWINKEL/BEAM ANGLE	CHF
30-324930	A60/MASTER LED Bulb matt, dim.	E27	7	2200-2700		200	17,40
30-325012	A60/MASTER LED Bulb matt		11	2200-2700		>300	21,72



B35 P45

LED RETROFIT/LED RETROFIT

ART. NR./CODE	INFO	FASSUNG/SOCKET	WATT	KELVIN	EEF	AUSSTRAHLUNGSWINKEL/BEAM ANGLE	CHF
30-377578	B35/CorePro LED Candle	E14	2	2700		>300	5,04
30-347748	CorePro LED Luster		2	2700		>300	5,04



Core Pro QPAR MASTER LED QPAR

LED RETROFIT/LED RETROFIT

ART. NR./CODE	INFO	FASSUNG/SOCKET	WATT	KELVIN	EEF	AUSSTRAHLUNGSWINKEL/BEAM ANGLE	CHF
30-752531	Core Pro LED Spot	GU10	4	2700		36	7,32
30-707517	Master LED Spot Expert Colour, dim.		4	3000		25	23,04
30-707579	Master LED Spot Expert Colour, dim.		4	3000		36	23,04
30-708118	Master LED Spot VLE, dim.		5	2200-2700		36	9,72
30-707630	Master LED Spot Expert Colour, dim.		6	3000		25	28,80
30-707692	Master LED Spot Expert Colour, dim.		6	3000		36	28,80
30-752517	Core Pro LED Spot		5	2700		36	7,80



AR111

LED RETROFIT/LED RETROFIT

ART. NR./CODE	INFO	FASSUNG/SOCKET	WATT	KELVIN	EEF	AUSSTRAHLUNGSWINKEL/BEAM ANGLE	CHF
30-333932	Master LED Spot Expert Colour, dim.	G53	11	2700		24	57,48
30-333994			11	3000		24	57,48
30-333956			11	2700		24	57,48
30-334014			11	3000		40	57,48
30-333819			15	2700		40	64,80



Core Pro Master LED

LED RETROFIT/LED RETROFIT

ART. NR./CODE	INFO	FASSUNG/SOCKET	WATT	KELVIN	EEF	AUSSTRAHLUNGSWINKEL/BEAM ANGLE	CHF
30-307063	MR16 Core Pro LED Spot	GU 5,3	5	2700		36	11,28
30-307186	MR16 MASTER LED Spot VLE, dim.		6	2700			20,16
30-307209	MR16 MASTER LED Spot VLE, dim.		6	3000			20,16
30-307322	MR16 MASTER LED Spot VLE, dim.		8	2700			28,80



QT 14

LED RETROFIT/LED RETROFIT

ART. NR./CODE	INFO	FASSUNG/SOCKET	WATT	KELVIN	EEF	AUSSTRAHLUNGSWINKEL/BEAM ANGLE	CHF
30-303898	Core Pro LED Capsule	G9	2	2700		300	14,88
30-303935			3				15,84
30-657802			5				31,68



QT 9

LED RETROFIT/LED RETROFIT

ART. NR./CODE	INFO	FASSUNG/SOCKET	WATT	KELVIN	EEF	AUSSTRAHLUNGSWINKEL/BEAM ANGLE	CHF
30-767655	Core Pro LED Capsule	G4	2	2700		300	12,36
30-767754			3				17,28

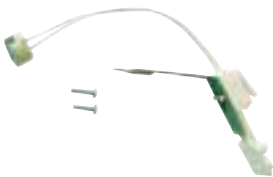
**FASSUNG GU5,3/SOCKET GU5,3**

ART. NR./CODE	INFO	L	CHF
259-502990	mit Klemme und Zugentlastung, 12V NV/ with clamp and strain relief, 12V NV	115	3,12

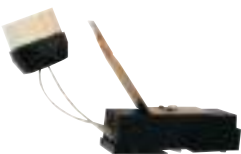
**FASSUNG GU10/SOCKET GU10**

ART. NR./CODE	INFO	CHF
259-502991	mit Klemme und Zugentlastung, 230V HV/ with clamp and strain relief, 1230V HV	5,76

24h SHOP

Unsere Produkte mit dem 24h Logo sind ab sofort auf Wunsch innerhalb von 24h versandbereit! Achtung: Unser 24h READY TO DELIVER Angebot gilt für den EU Raum!/
 Our products with the 24h logo are now ready for dispatch within 24h on request! Attention: Our 24h READY TO DELIVER offer is valid for the EU area!



Jetzt einfach im Webshop bestellen/Order now in our webshop:



LIEFER- UND VERKAUFSBEDINGUNGEN/TERMS OF DELIVERY AND SALE

Mit Erscheinen dieses Kataloges verlieren alle bisherigen Preise ihre Gültigkeit. Wir liefern ausschließlich nach unseren gültigen Liefer- und Verkaufsbedingungen. Die Ware bleibt bis zur vollständigen Bezahlung im Eigentum der Molto Luce GmbH. Es gelten unsere allgemeinen Geschäftsbedingungen, abrufbar auf www.moltoluce.com.

With the publication of this catalogue, all previous prices lose their validity. We deliver exclusively according to our valid delivery and sales conditions. The goods remain the property of Molto Luce GmbH until payment has been made in full. Our general terms and conditions apply, available at www.moltoluce.com.

HAFTUNGSAUSSCHLUSS UND NUTZUNGSRECHT/DISCLAIMER AND RIGHT OF USE

Alle Daten in diesem Katalog haben rein informativen Wert. Die Molto Luce GmbH behält sich das Recht vor, die Daten ohne vorhergehende Bekanntgabe oder Begründung zu ändern. Alle Maße sind in Natur zu prüfen. Zudem sind manche, im Katalog abgebildeten Produkte Bildretuschen oder Renderings, die ausschließlich zur Veranschaulichung der Einsatzmöglichkeiten dienen. Für mögliche Irrtümer, Satz- oder Druckfehler sowie Farbabweichungen übernimmt die Molto Luce GmbH keinerlei Haftung. Inhalte und Bilder aus diesem Katalog dürfen ohne Zustimmung der Molto Luce GmbH weder, bearbeitet, vervielfältigt noch veröffentlicht werden.

All data in this catalogue has purely informative value. Molto Luce GmbH reserves the right to modify the data without prior notice or justification. All measurements are to be checked in nature. In addition, some products shown in the catalogue are picture retouchings or renderings which serve exclusively to illustrate the application possibilities. Molto Luce GmbH accepts no liability for possible errors, typesetting or printing errors or colour deviations. Contents and pictures from this catalogue may not be edited, reproduced or published without the consent of Molto Luce GmbH.

QR-CODE SCANNEN UND ALLE WICHTIGEN INFOS ZM PRODUKT ERHALTEN/ SCAN QR-CODE AND GET ALL IMPORTANT INFORMATION ABOUT THE PRODUCT

Scannen sie den QR-Code der Produkte und erhalten sie sämtliche benötigte Informationen wie z.B. Preise, Lagerstand, Datenblatt, Montageanleitungen, LTD Dateien, ULD-Dateien, 3-DS Dateien und Ausschreibungstexte auf ihr Tablet oder Mobiltelefon./

Click the QR code of the products and get all the information you need, such as prices, stock levels, data sheets, mounting instructions, LTD files, ULD files, 3-DS files and tender texts on your mobile phone or tablet.



KALIO SQUARE R

INFORMATION

Einbastrahler,
Aluminiumdruckguss,
Feinstruktur matt
pulverbeschichtet,
schwenkbar 45°,
zurückversetzte Licht-
quelle, exkl. Konverter

LEISTUNG	mA	LUMEN	CRI>	KELVIN	L x B x ET	DA L x B	FARBE	REFL.	ART.NR.
LED 8W	250	860	90	2700	96 x 96 x 83	80 x 80	weiß	24°	308-30023500
LED 8W	250	860	90	2700	96 x 96 x 83	80 x 80	schwarz	24°	308-30023600
LED 8W	250	860	90	2700	96 x 96 x 83	80 x 80	weiß	38°	308-30033500
LED 8W	250	860	90	2700	96 x 96 x 83	80 x 80	schwarz	38°	308-30033600
LED 8W	250	900	90	3000	96 x 96 x 83	80 x 80	weiß	24°	308-30029500
LED 8W	250	900	90	3000	96 x 96 x 83	80 x 80	schwarz	24°	308-30029600
LED 8W	250	900	90	3000	96 x 96 x 83	80 x 80	weiß	38°	308-30039500
LED 8W	250	900	90	3000	96 x 96 x 83	80 x 80	schwarz	38°	308-30039600



MOLTO LUCE - EIN LEITBETRIEB/MOLTO LUCE - A LEAD COMPANY

Molto Luce führt das Qualitätszeichen der Leitbetriebe Austria. Damit werden Unternehmen ausgezeichnet, die nicht auf kurzfristige Gewinne setzen, sondern auf nachhaltigen Unternehmenserfolg. Betriebe, die durch die Markt- und Werteorientierung zur Entwicklung der Region und Branche beitragen.
www.leitbetriebe.at

Molto Luce carries the quality mark of the leading Austrian companies. It is awarded to companies that do not rely on short-term profits, but on sustainable corporate success, companies that contribute to the development of the region and industry through market and value orientation.

www.leitbetriebe.at



Leitbetrieb
Österreich

MOLTO LUCE - TOP SUPPLIER RETAIL 2019/MOLTO LUCE - TOP SUPPLIER RETAIL 2019

Molto Luce wurde als Lösungspartner des EHI Energiemanagement-Award-Preisträgers Metro Cash & Carry Österreich GmbH in der Kategorie „Pilotfilialen mit vorbildlicher Energieeffizienz/Nachhaltigkeit“ mit dem Topp Supplier Retail Award 2019 ausgezeichnet.

In den Augen der Jury haben wir mit einem besonders erfolgreichen Konzept zur Energieeinsparung und zum ressourcenschonenden Einsatz von Energie in der Filiale unseres Partners einen wesentlichen Beitrag geleistet.

Molto Luce was awarded the Top Supplier Retail Award 2019 in the category „Pilot stores with exemplary energy efficiency/sustainability“ as solution partner of the EHI Energy Management Award winner Metro Cash & Carry Austria GmbH.



DIMMEN VON LED & LEUCHTSTOFFLAMPEN/DIMMING OF LEDS AND FLUORESCENT BULBS

DIMMEN DALI - TASTER/DIMMING DALI - PUSH BUTTON

nur DALI EVGs mit integrierter Touch DIM Funktion/only DALI ECGs with integrated touch DIM function
für max. 2 EVGs möglich, 1-Phasen Betrieb möglich/for max. 2 ECGs possible, 1-phase operation possible

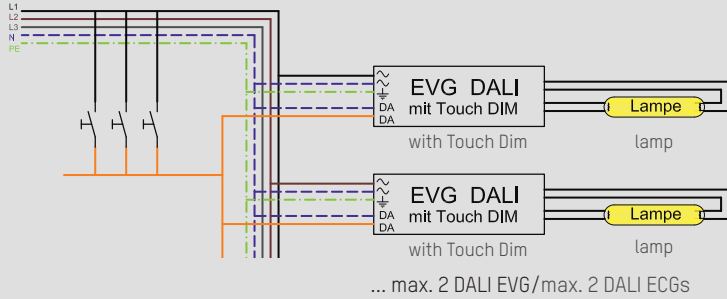

Schalten und Dimmen mit allen handelsüblichen Tastern/switching and dimming with all commercial push buttons

DIMMEN DALI - DALI MCU

alle DALI EVGs

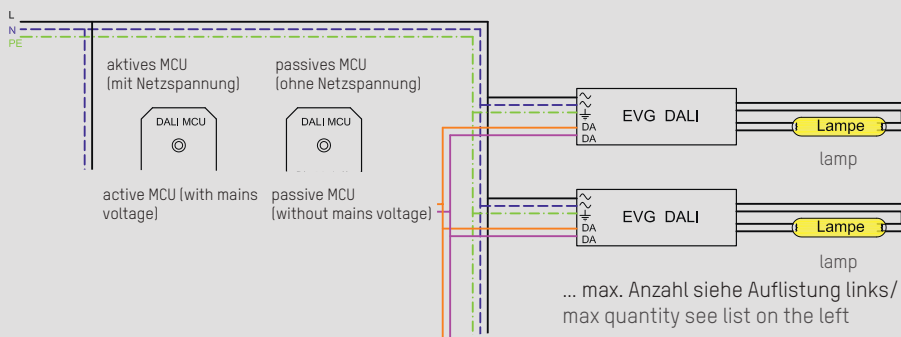

Schalten und Dimmen mit dem DALI Drehrad MCU/switching and dimming with DALI rotary knob MCU

je aktivem MCU ist ein passives MSU anschließbar, insgesamt sind maximal 4 MCU möglich.

One passive MSU can be connected per active MCU; a maximum of 4 MCUs are possible in total.

- 1 aktives MCU: max. 25 DALI EVG
 - 1 aktives MCU + 1 passives MCU: max. 25 DALI EVG
 - 2 aktive MCU: 50 DALI EVG
 - 2 aktive MCU + 2 passives MCU: max. 50 DALI EVG
 - 3 aktive MCU: 75 DALI EVG
 - 3 aktive MCU + 1 passives MCU: max. 75 DALI EVG
 - 4 aktive MCU: max. 100 DALI EVG
- 1 active MCU: max. 25 DALI ECGs
 - 1 active MCU + 1 passive MCU: max. 25 DALI ECGs
 - 2 active MCU: 50 DALI ECGs
 - 2 active MCUs + 2 passive MCUs: max. 50 DALI ECGs
 - 3 active MCU: 75 DALI ECGs
 - 3 active MCUs + 1 passive MCU: max. 75 DALI ECGs
 - 4 active MCU: max. 100 DALI ECGs

DIMMEN DALI - DALI REPEATER SO

alle DALI EVGs, für max. 64 EVGs/all DALI ECGs, for max. 64 ECGs

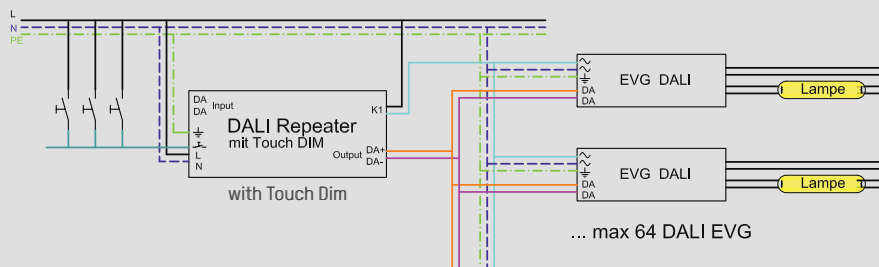

LED - HINWEISE ZUR VERKABELUNG

Der Anschluss von elektrischen Verbrauchern an das elektrische Stromnetz unterliegt bestimmten Kriterien, diese sind Spannung, Strom, Polarität und Frequenz, und wir unterscheiden wie folgt:

1. Spannung

Alle Verbraucher, die die gleiche Spannung benötigen, werden parallel an die Spannungsquelle angeschlossen. Die Höhe des Stroms, der durch die einzelnen Verbraucher fließt, wird durch den Verbraucher bestimmt.

Transformatoren konventioneller Bauart sind Geräte welche Wechselspannung in der Höhe verändern können, z.B. von 230V/50Hz auf 12V/50Hz.

Transformatoren elektronischer Bauart sind Geräte welche Wechselspannung in der Höhe verändern können, dabei aber auch die Frequenz verändern, z.B. von 230V/50Hz auf 12V/20kHz. 12V Glühlampen kommen damit zurecht, andere Verbraucher aber nicht, auch keine 12V LEDs. (Ausnahme LED Retrofit)

LED-WIRING INSTRUCTIONS

The connection of electrical load to the electrical grid is subject to certain criteria, these are voltage, current, polarity and frequency, and we differentiate as follows:

1. voltage

All loads that require the same voltage are connected in parallel to the voltage source. The amount of current flowing through the individual loads is determined by the load.

Conventional transformers are devices that can change the level of alternating voltage e.g. from 230V/50Hz to 12V/50Hz.

Electronic transformers are devices that can change the level of alternating voltage, but which can also change the frequency, e.g. from 230V/50Hz to 12V/20kHz. 12V light bulbs can cope with this, but other consumers cannot, including no 12V LEDs. (Exception LED retrofit)

LED-KONVERTER RGB 1-10V & PUSH & IR/LED- DRIVER RGB 1-10V & PUSH & IR

**DIMMEN WEISSER LED STRIPES 24 V/DIMMING WHITE LED STRIPES 24V
DIMMEN PER TASTER/DIMMING WITH PUSH BUTTON**

kurzer Tastendruck zum Ein-/Ausschalten, langer Tastendruck zum Auf-/Abdimmen, mit Auto-Stop bei minimalen und maximalen Werten mit dimmbarem Betriebsgerät VSTR 120 (230V-50Hz auf 0-24V DC) 24V Konverter (100W) für maximal 1 x 6,9m weißes LED Strip 24V (je 14.4W/lfm)

short press to switch on/off, long press to dim up/down, with auto-stop at minimum and maximum values with dimmable control gear VSTR 120 (230V-50Hz to 0-24V DC) 24V converter (100W) for a maximum of 1 x 6.9m white LED strip 24V (14.4W/running meter each)

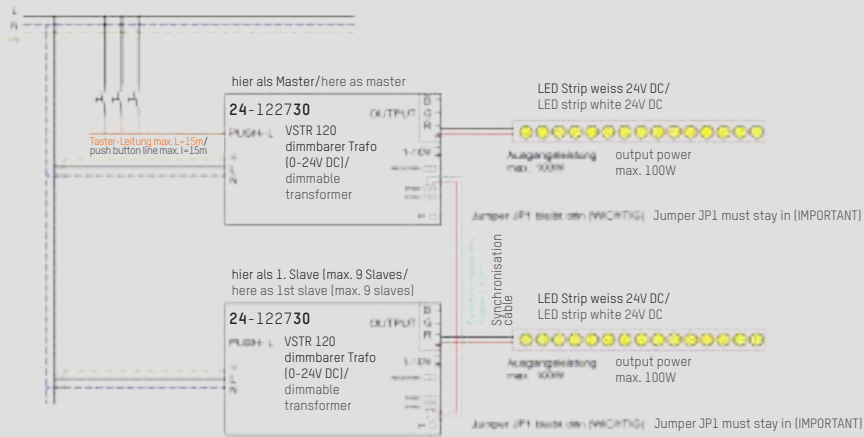

**DIMMEN WEISSER LED STRIPES 24 V/DIMMING WHITE LED STRIPES
DIMMEN 1-10V/DIMMING 1-10V**

Dimmen mit Potentiometer am 1-10V Eingang mit dimmbarem Betriebsgerät VSTR 120 (230V-50Hz auf 0-24V DC) 24V Konverter (100W) für maximal 1 x 6,9m weißes LED Strip 24V (je 14.4W/lfm)

Dimming with potentiometer at 1-10V input with dimmable control gear VSTR 120 (230V-50Hz to 0-24V DC) 24V converter (100W) for max. 1 x 6.9m white LED Strip 24V (14.4W/running meter each)

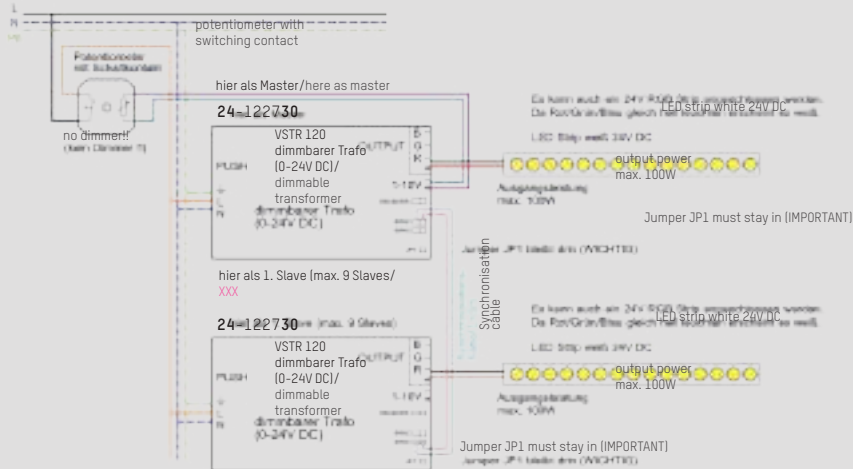

**DIMMEN RGB LED STRIPES 24 V/DIMMING RGB LED STRIPES 24V
DIMMEN PER FERNBEDIENUNG/DIMMING VIA REMOTE CONTROL**

Infrarotfernbedienung: es können alle drei Farbkanäle einzeln oder gemeinsam gedimmt werden + einfacher Farbdurchlauf mit dimmbarem Betriebsgerät VSTR 120 (230V-50Hz auf 0-24V DC) 24V Konverter (120W) für maximal 1 x 8,5m weißes LED Strip 24V (je 14.4W/lfm)

Infrared remote control: all three color channels can be dimmed individually or together + simple color flow with dimmable control gear VSTR 120 (230V-50Hz to 0-24V DC) 24V converter (120W) for a maximum of 1 x 8.5m white LED Strip 24V (14.4W/running meter each)

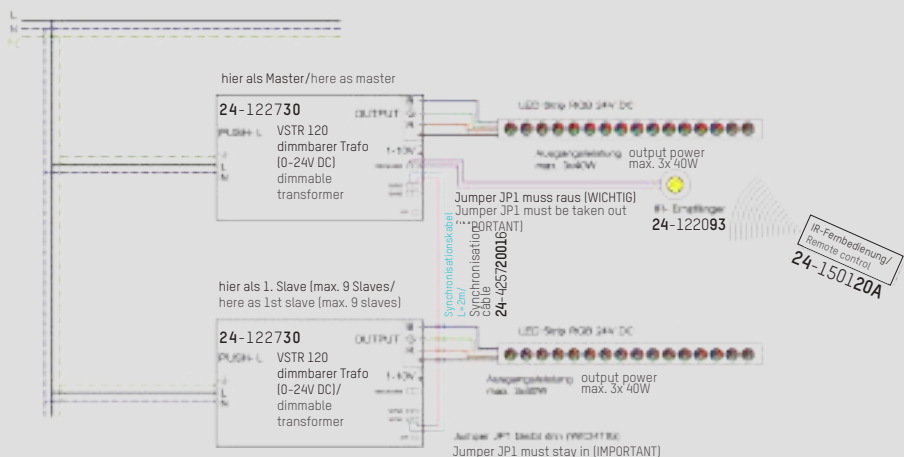

MAXI JOLLY

DIMMEN POWER LEDS/DIMMING POWER LEDS DIMMEN PER TASTER/DIMMING VIA PUSH BUTTON

Kurzer Tastendruck zum Ein/Ausschalten, langer Tastendruck zum Auf/Ab-dimmen. Mit Auto-Stop bei min. und max. Werten, die Stellung der DIP-Schalter (DIP switch) legt den Konstantstrom des Konverters am Ausgang fest.

Short press to switch on/off, long press to dim up/down. With auto-stop at min. and max. values, the position of the DIP switches determines the constant current of the converter at the output.

max. 9 Slaves

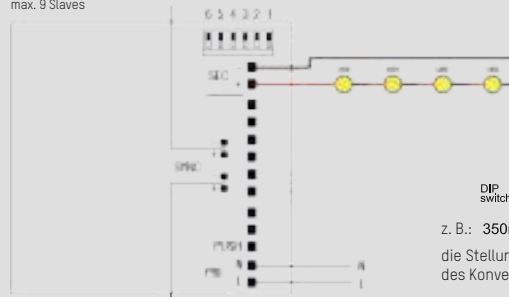

z. B.: 350mA 500mA 700mA

die Stellung der DIP-Schalter (DIP switch) legt den Konstantstrom des Konverters am Ausgang fest

the adjustment of the DIP-switch determines the constant current on the secondary side of the driver

hier als Master/
here as master

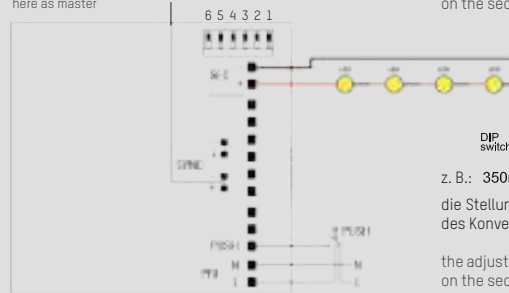

z. B.: 350mA 500mA 700mA

die Stellung der DIP-Schalter (DIP switch) legt den Konstantstrom des Konverters am Ausgang fest

the adjustment of the DIP-switch determines the constant current on the secondary side of the driver

DIMMEN POWER LEDS/DIMMING POWER LEDS DIMMEN 1-10V/DIMMING 1-10V

Dimmen mit Potentiometer am 1-10V Eingang mit dimmbarem Betriebsgerät MAXI JOLLY, die Stellung der DIP-Schalter (DIP switch) legt den Konstantstrom des Konverters am Ausgang fest.

dimming with potentiometer at the 1-10V input with dimmable MAXI JOLLY control gear, the position of the DIP switch determines the constant current of the converter at the output.

max. 9 Slaves

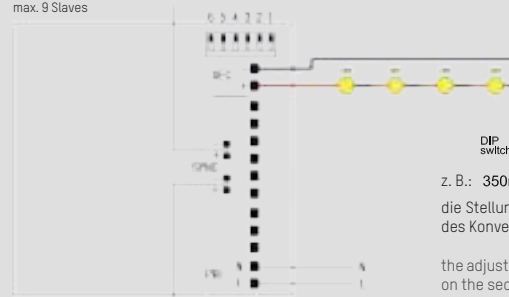

z. B.: 350mA 500mA 700mA

die Stellung der DIP-Schalter (DIP switch) legt den Konstantstrom des Konverters am Ausgang fest

the adjustment of the DIP-switch determines the constant current on the secondary side of the driver

hier als Master/
here as master

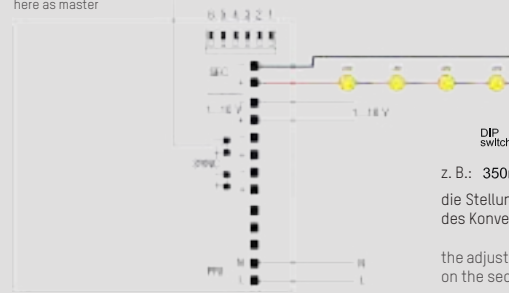

z. B.: 350mA 500mA 700mA

die Stellung der DIP-Schalter (DIP switch) legt den Konstantstrom des Konverters am Ausgang fest

the adjustment of the DIP-switch determines the constant current on the secondary side of the driver

DIMMEN POWER LEDS/DIMMING POWER LEDS DIMMEN DALI/DIMMING DALI

Dimmen über DALI Steuerung, die Stellung der DIP-Schalter (DIP switch) legt den Konstantstrom des Konverters am Ausgang fest.

dimming via DALI control, the position of the DIP switch determines the constant current of the converter at the output.

max. 9 Slaves



z. B.: 350mA 500mA 700mA

die Stellung der DIP-Schalter (DIP switch) legt den Konstantstrom des Konverters am Ausgang fest

the adjustment of the DIP-switch determines the constant current on the secondary side of the driver

hier als Master/
here as master



z. B.: 350mA 500mA 700mA

die Stellung der DIP-Schalter (DIP switch) legt den Konstantstrom des Konverters am Ausgang fest

the adjustment of the DIP-switch determines the constant current on the secondary side of the driver

DALieco ALS MANUELLE TASTENSTEUERUNG/DALIECO AS MANUAL PUSH BUTTON CONTROLLER



Manuelles Dimmen und Schalten von bis zu 32 EVG's
Länge des Anschlusskabels zu den Tasten von bis zu 50m, beliebig viele Teilnehmer

Manual dimming and switching up to 32 drivers
length of the connection cable to the push buttons up to 50m, any number of push buttons connectable

DALieco ALS MANUELLE 2-KANAL-TASTENSTEUERUNG (kein Sensor angeschlossen)/ DALIECO AS MANUAL 2-CHANNEL-PUSH-BUTTON CONTROLLER (WITHOUT CONNECTED SENSOR)

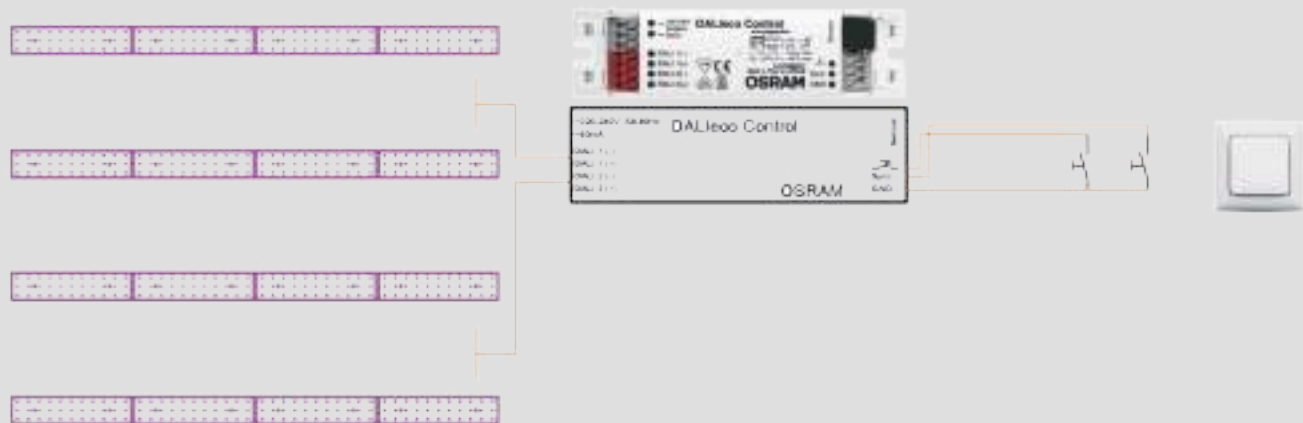

Manuelles Dimmen und Schalten von bis zu 2 x 16 EVGs
Aktivierung des Tastersteuerungseingangs für Kanal 2 durch gleichzeitiges Drücken beider Taster für 10 Sek.
Länge des Anschlusskabels zu den Tastern von bis zu 50m, beliebig viele Taster anschließbar

manual dimming and switching of up to 2x 16 drivers activation of the switch control input for channel 2, simultaneous pressing of both push buttons for 10 seconds.
length of the connection cable to the push buttons up to 50m, any number of push buttons connectable

DALieco FÜR DIE AUTOMATISCHE LICHTSTEUERUNG VON EINZELLEUCHTEN/EINZELBÜROS /DALIECO FOR AUTOMATIC LIGHT CONTROL OF SINGLE LAMPS/SINGLE OFFICES

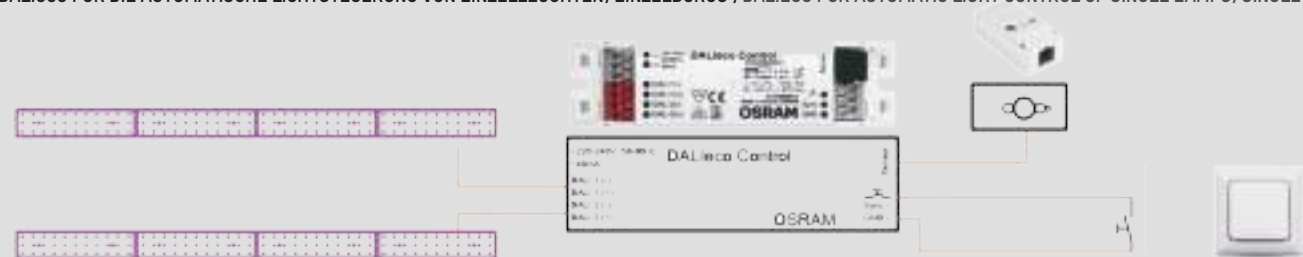

Länge des Anschlusskabels zu den Tastern von bis zu 50m, beliebig viele Taster anschließbar

length of the connection cable to the push buttons up to 50m, any number of push buttons connectable

UNIVERSALDIMMER/UNIVERSAL DIMMER

Dimmer zur Ansteuerung über DALI, 1 - 10V oder PUSH Dimm. für weiße 24V LED Stripes

Dimmer for control via DALI, 1 - 10V or PUSH Dimm. for white 24V LED Stripes

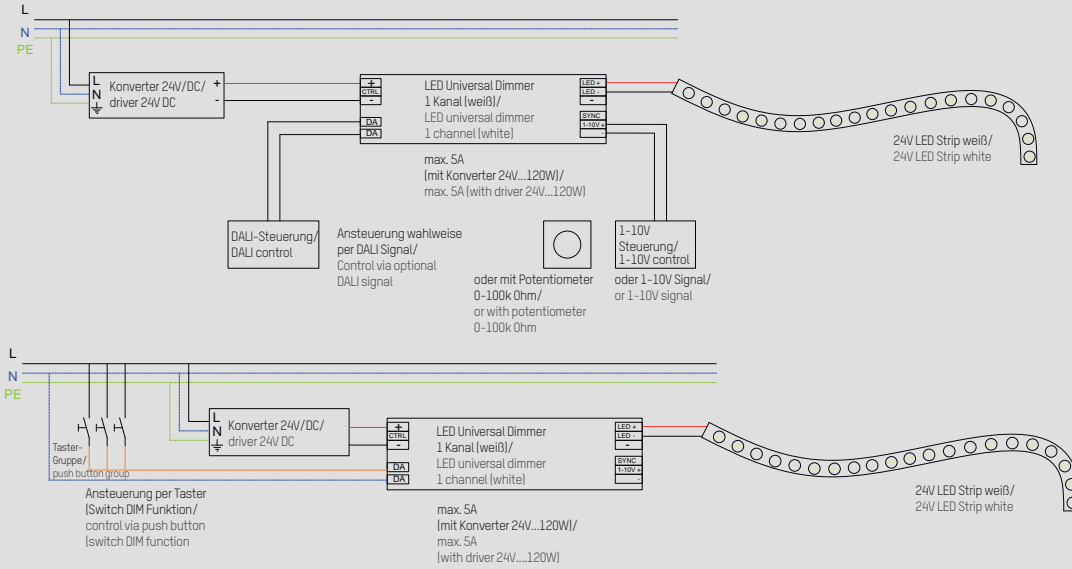

DMX 200/DMX 200

Dimmen DMX/DALI-RGB FÜR RGB LED 24V STRIPES, für die DMX oder DALI Ansteuerung von max. 2x 5m RGB LED's 24V bei 14,4W/lm (entspricht 144W Gesamtleistung)

Dim DMX/DALI-RGB for RGB LED 24V stripes, for DMX or DALI control of max. 2x 5m RGB LED's 24V at 14.4W/ running meter

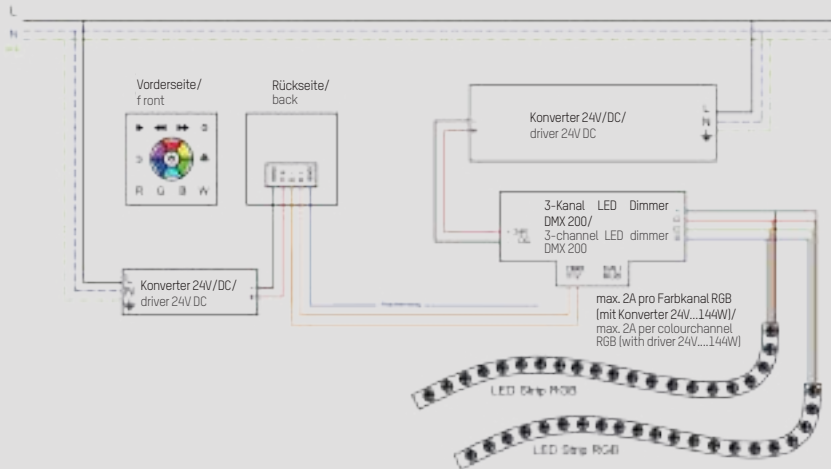

DMX RGBW DIMMER/DMW RGBW DIMMER

für die DMX Ansteuerung von max. 14m RGBW LED Stripes 24V bei 17,3W/lm (Entspricht 250W Gesamtleistung)

for DMX control of max. 14m RGBW LED Stripes 24V at 17.3W/lm (matches 250W total output)

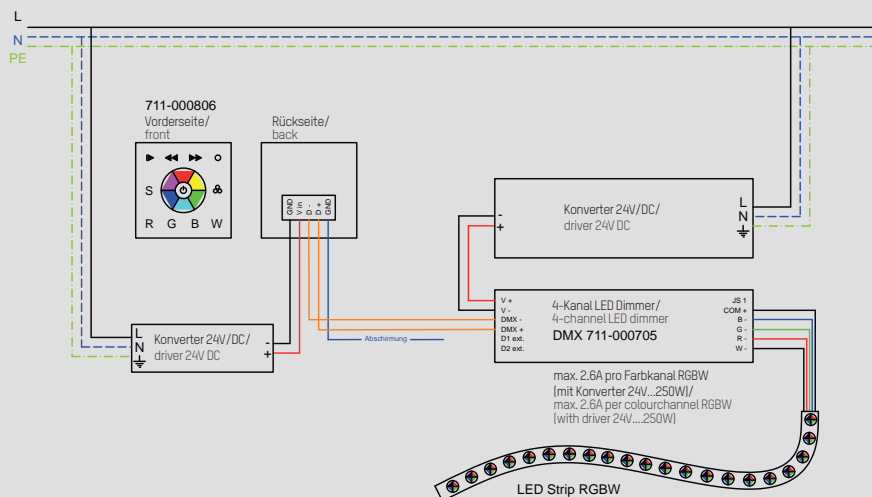

RGBW FUNKDIMMER/RGBW RADIO DIMMER

Zur Ansteuerung von 24V LED Stripes RGB, RGBW oder weißen 24V LED Stripes. Kommunikation zwischen Controller und Bedienstellen erfolgt über Funk.
Optionale APP Steuerung möglich (siehe unten)

For controlling 24V LED Stripes RGB, RGBW or white 24V LED Stripes. Communication between controller and control points via radio.
Optional APP control possible (see below)

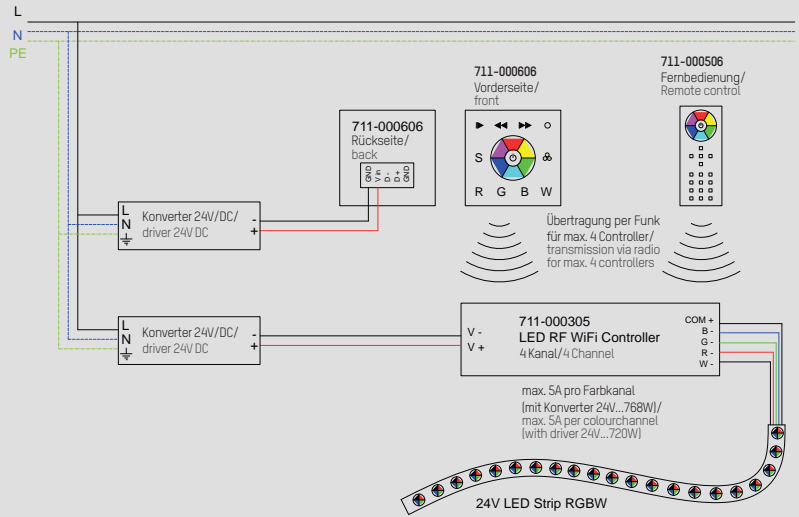

RGBW FUNKDIMMER/RGBW RADIO DIMMER

APP Steuerung des RGBW Funkdimmers zur Integration in ein häuseigenes WLAN, APP steht zum kostenlosen Download in diversen APP Stores zur Verfügung

APP control of the RGBW wireless dimmer for integration into an in-house WLAN, APP is available for free download in available in various APP stores

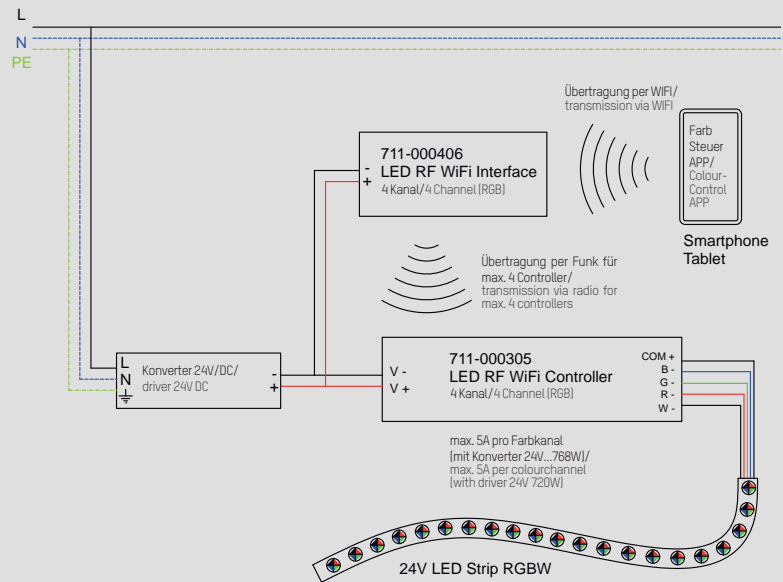

FUNK DIMMER TUNABLE WHITE/RADIO DIMMER TUNABLE WHITE

2-Kanal Funk Dimmer für die Ansteuerung von Tunable White LED Stripes
max. 5A/Kanal, 110-240W/24V

2-channel wireless dimmer for controlling Tunable White LED Stripes
max. 5A/channel, 110-240W/24V

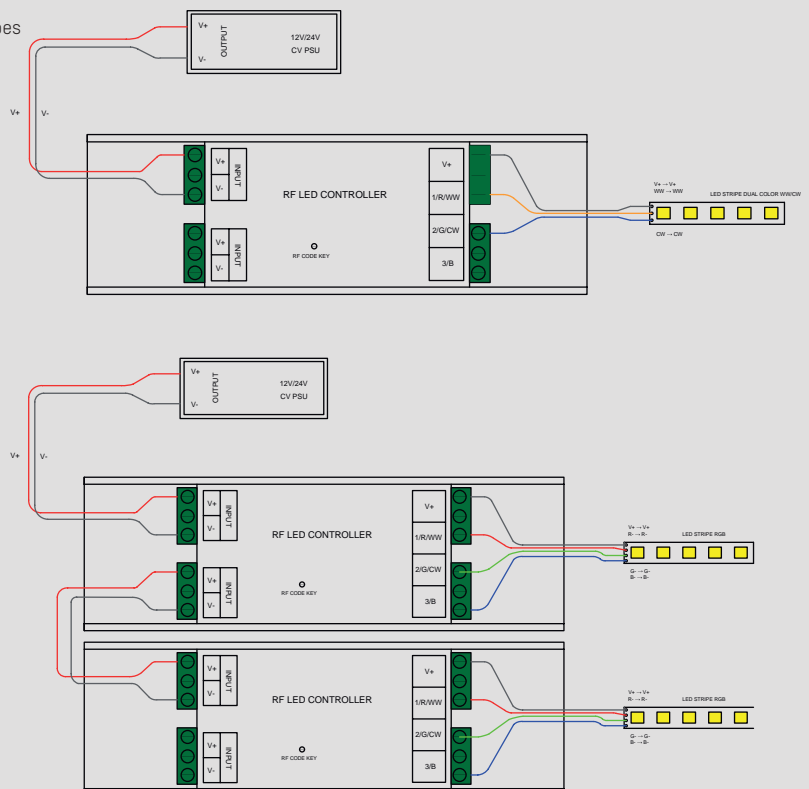

DALI DT8 / PUSH LED KONVERTER/DALI DT8/ PUSH LED DRIVER

LED Konverter für LED Stripes, dimmbar DALI DT8 Push Dimm. 2 Kanal - max. 75W./LED driver for LED stripes, dimmable DALI DT8 push dimm. 2 channel - max. 75W

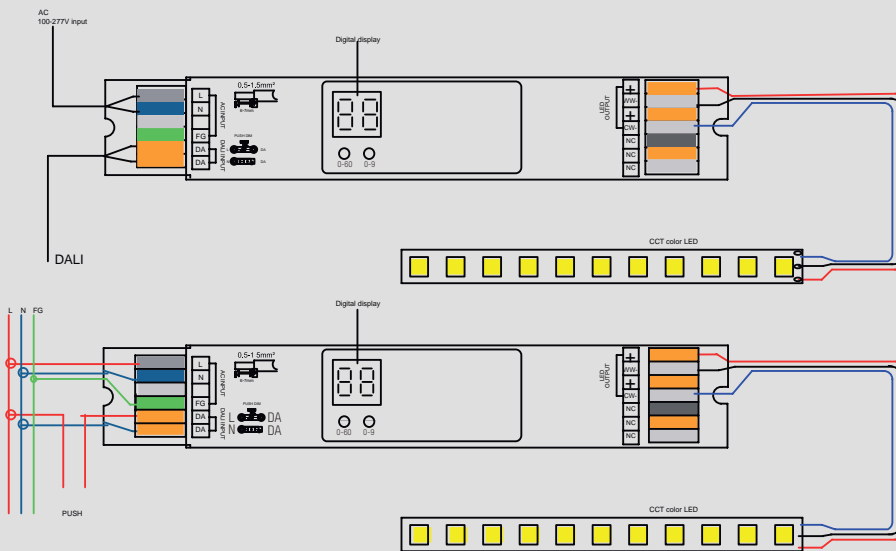

DALI / PUSH LED KONVERTER/DALI/ PUSH LED DRIVER

LED Konverter für LED Stripes, dimmbar DALI Push Dimm. 2 Kanal - max. 30W. /LED driver for LED stripes, dimmable PUSH dimm. 2 channel - max. 30W

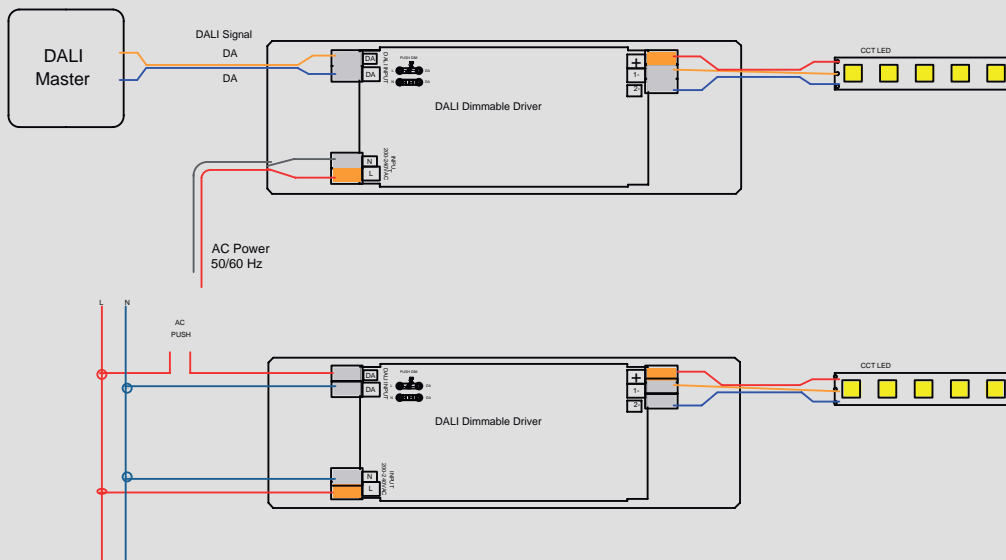

DALI / PUSH LED KONVERTER/DALI / PUSH LED DRIVER

LED Konverter für LED Stripes, dimmbar DALI Push Dimm. 1 Kanal - max. 150W. /LED driver for LED stripes, dimmable DALI Push dimm. 1 channel - max. 150W

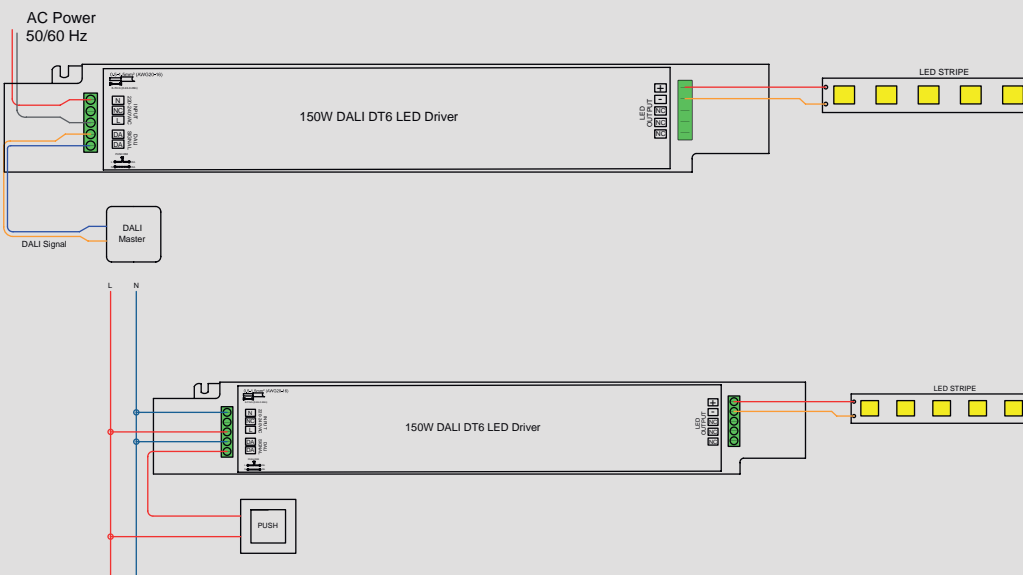

LED KONVERTER QT DALI/LED DRIVER QT DALI

28-177900 - 50W - DALI
28-177924 - 80W - DALI

LED Konverter für LED Stripes, dimmbar DALI Push Dimm. 1 Kanal - max. 50W./LED driver for LED stripes, dimmable DALI Push Dimm. 1 channel - max. 50W
LED Konverter für LED Stripes, dimmbar DALI Push Dimm. 1 Kanal - max. 80W. /LED driver for LED stripes, dimmable DALI Push Dimm. 1 channel - max. 80W

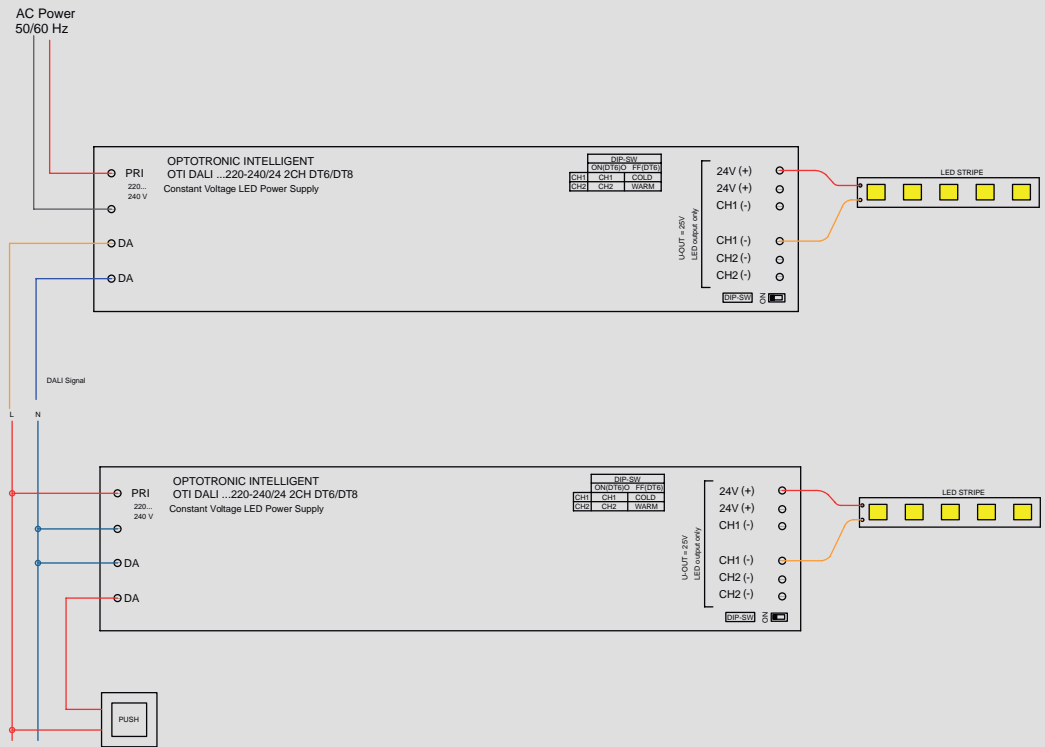

DALI DT8 / PUSH LED DIMMER - 4 KANAL/DALI DT8 / PUSH LED DIMMER - 4 CHANNEL

Dimmer für LED Stripes, DALI DT8 RGB/W, tunable white, 60-180W/24V/dimmer for LED stripes, DALI DT8 RGB/W, tunable white, 60-180W 24V

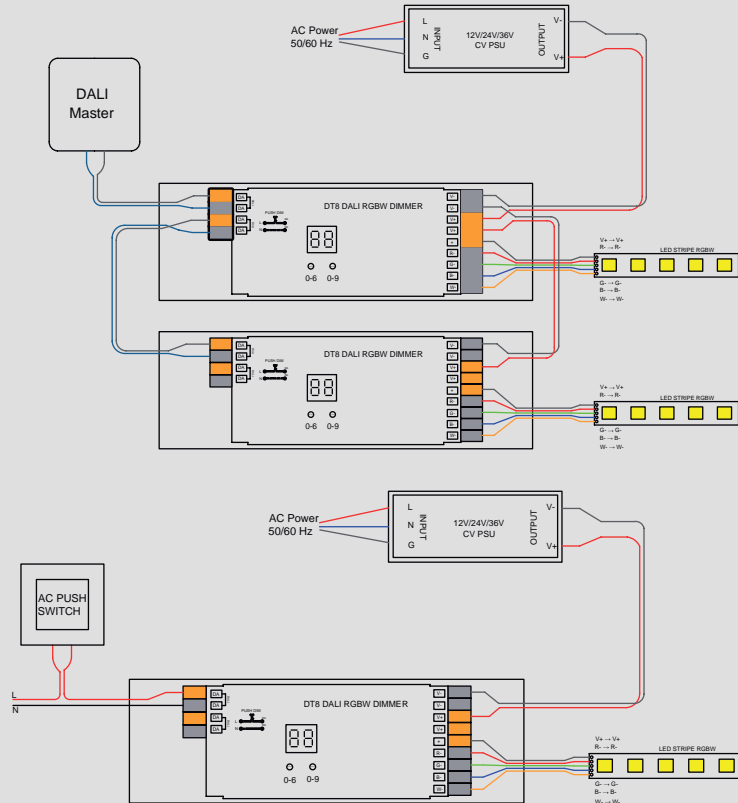

DALI DT8 / RGBW-TOUCHPANEL

Lichtszenencontroller DALI DT8 RGB/W, 4 Szenen konfigurierbar, Montage in Standard-Einbaudose Ø 68mm.

Light scene controller DALI DT8 RGB/W, 4 scenes configurable, mounting in standard recessed box Ø 68mm.

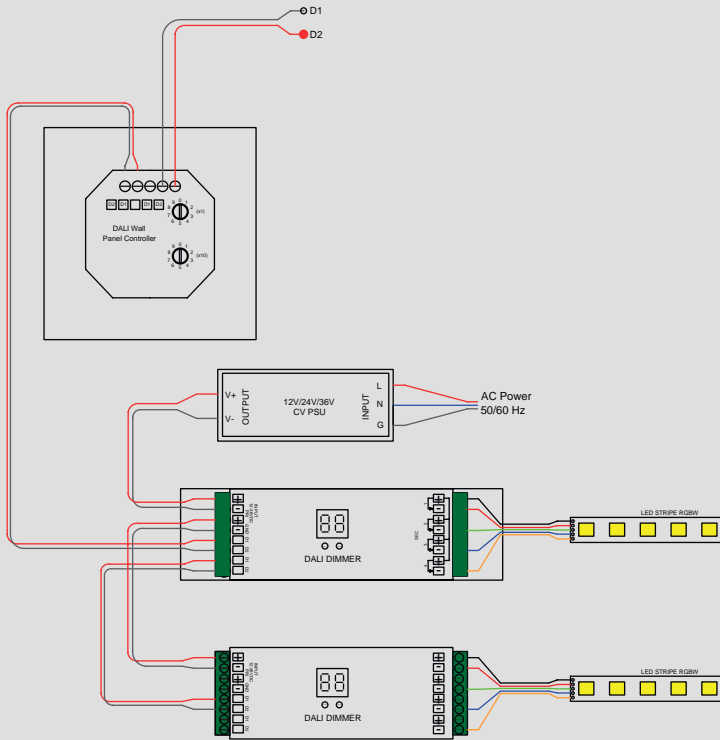

DALI DT8 TUNABLE WHITE - TOUCHPANEL

Lichtszenencontroller DALI DT8 tunable white, 4 Szenen konfigurierbar, Montage in Standard-Einbaudose Ø 68mm.

Light scene controller DALI DT8 tunable white, 4 scenes configurable, installation in standard recessed box Ø 68mm.

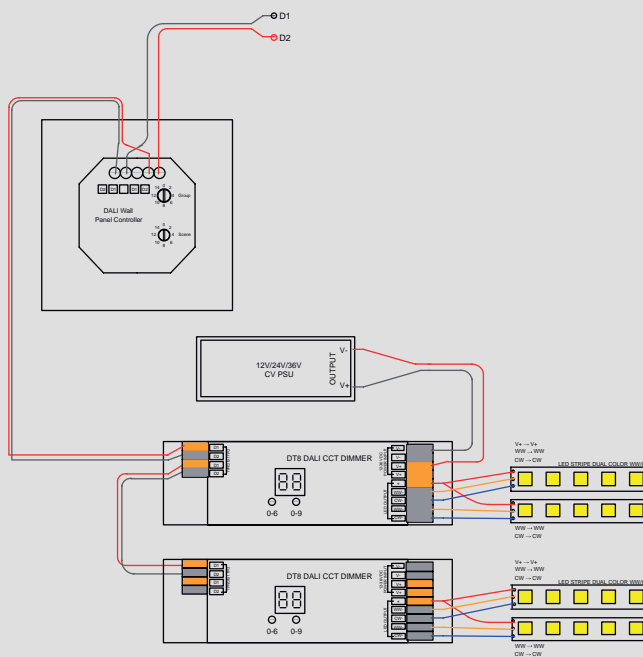

PUSH BUTTON INTERFACE

Zur Integration von handelsüblichen Tastern in die MOLTO LUCE Smart App. 3 Kanal UP-Dosenmodul

For integrating commercially available push-buttons into the MOLTO LUCE Smart App. 3 channel flush-mounted box module

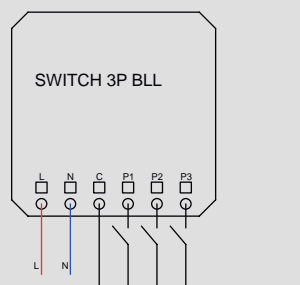

INTERFACE SMART BLUETOOTH TO DALI

Zur Integration von max. 40 Dali dimmbaren Leuchten in die MOLTO LUCE Smart App.

For integration of max. 40 Dali dimmable luminaires in the MOLTO LUCE Smart App.

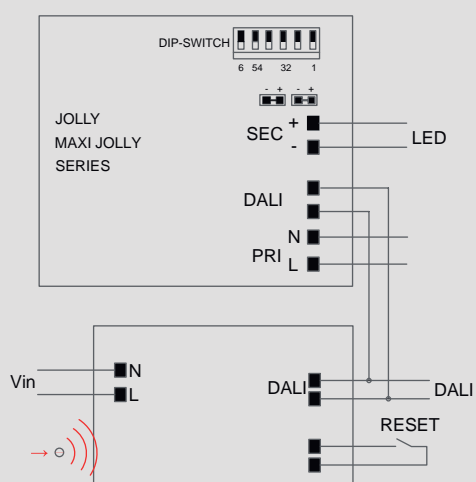





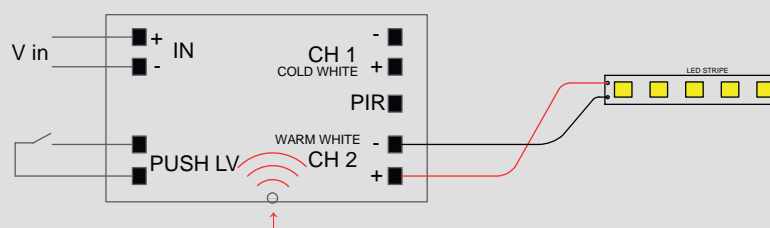



























BLUETOOTH DIMMER-2 KANAL/BLUETOOTH DIMMER- 2 CHANNEL

BLUETOOTH DIMMER-2 KANAL/bluetooth dimmer- 2 channel



Symbole/symbols

	Deckeneinbau/ceiling recessed		Decken-oder Wandausschnitt eckig/ ceiling-wall cutout square
	Deckenaufbau/surface mounted		UGR-Wert, je niedriger, desto blendfreier/ UGR-value, the lower, the less glare
	Pendelleuchten/pendant luminaires		Dim2Warm-Funktion ändert sich die Lichtfarbe wenn man die Leuchte dimmt und damit die Lichtstärke abnimmt/ Dim2Warm-function changes the light colour when the lamps is dimmed down
	Wandeinbau/recessed wall		Tunable-White-Funktion ändert sich die Lichtfarbe bei gleicher Lichtstärke/ Tunable-white-function changes light colour at the same light output
	Wandaufbau/ceiling wall		48 Volt Gleichstromspannung/48 volt direct current
	Decken-Wandeinbau/ceiling-wall recessed		Erlaubt Montage eines elektrischen Betriebsgerätes auf Werkstoffen, deren Entflammverhalten nicht bekannt sind / permits the installation of an electrical control gear on materials whose flammability behavior is not known
	Stehleuchte/Floor lamp		Max. Oberflächentemperatur an Betriebsgeräten/ max. surface temperature on the driver
	Decken-Wandaufbau/Surface mounted ceiling-/walllamp		Unabhängiger Konverter: Betriebsgerät auch zur Verwendung außerhalb von Leuchten/ independent driver: driver also can be used outside of the luminaire
	Stromschiene/tracklight		Kurzschlussfestes Sicherheitsbetriebsgerät/ short curcuit safe driver
	Bodeneinbau/recessed ground light		
	Poller/bollard		
	Tischleuchte/table lamp		
	Schutzklasse I/protection class I		
	Schutzklasse II/protection class II		
	Schutzklasse III/protection class III		
IP20 	IP-Schutzart/IP-protection class		
IK02	Stoßfestigkeit/impact protection		
	dimmbar/dimmable		
	DALI 2 dimmbar/DALI 2 dimmable		
	Tastdimmer/touch dimmer		
	Sensor Dimmer/sensor dimmer		
	Energieeffizienz/energy efficiency		
	schwenkbar/tilting		
	schwenkbar/turnable		
	Decken-oder Wandausschnitt rund/ ceiling-wall cutout round		

IP - SCHUTZARTEN/IP PROTECTION CLASSES

1. Ziffer/Digit	Berührungsschutz/touch protection	Schutz gegen das Eindringen von Fremdkörpern und Staub/ protection against penetration of foreign objects or dust
IP 0X	ungeschützt/no protection	kein besonderer Schutz/no special protection
IP 1X	Schutz gegen Fremdkörper > 50 mm/ protection against foreign objects >50mm	Größere Körperteile wie eine Hand (jedoch keine Schutzmaßnahme gegen bewusste Berührung/ bigger body part e.g. hands (no protection against conscious touch)
IP 2X	Schutz gegen Fremdkörper > 12 mm/ protection against foreign objects >12mm	Finger und dergleichen bis 80 mm Länge; Fremdkörper >12 mm Durchmesser/ fingers and similar up to 80mm length; foreign objects >12mm diameter
IP 3X	Schutz gegen Fremdkörper > 2,5 mm/ protection against foreign objects >2,5mm	Werkzeuge, Drähte usw. mit Durchmesser oder Dicke > 2,5 mm; Fremdkörper > 2,5mm/ tools, wires etc. with diameter or thickness >2,5mm; foreign objects >2,5mm
IP 4X	Schutz gegen Fremdkörper >1 mm/ Protection against foreign bodies	Drähte oder Streifen > 1mm; Fremdkörper > 1 mm Durchmesser/ wires or stripes >1mm; foreign objects >1mm diameter
IP 5X	Staubschutz/dust protection	Eindringen von Staub wird nicht völlig verhindert, aber Staub dringt nicht in solchen Mengen ein, dass ordnungsgemäßer Betrieb behindert wird./ penetration of dust not completely prevented, but dust cant penetrate in such high quantity to prevent nor mal operation
IP 6X	Staubdicht/dust-tight	kein Eindringen von Staub/no penetration of dust
2. Ziffer/Digit	Wasserschutz/Water protection	Schutz gegen das Eindringen von Wasser/Protection against the ingress of water
IP X0	ungeschützt/no protection	kein besonderer Schutz/no special protection
IP X1	Schutz gegen Tropfwasser/ protection against dripping water	Tropfwasser (senkrecht fallende Tropfen) verursacht keine Schädigung./ bigger body part e.g. hands (no protection against conscious touch)
IP X2	Schutz gegen Tropfwasser unter 15°/ protection against dripping water under 15°	Senkrecht fallende Tropfen dürfen keine Schädigung bewirken, wenn das Gehäuse bis zu 15° aus seiner bestimmungsgemäßen Gebrauchslage gekippt wird./ vertical falling drips must not cause damages, even if the housing is tilted 15° to its intended use position
IP X3	Schutz gegen Sprühwasser / protection against spray-water	Sprühwasser darf aus einer Neigung bis 60° gegen die Senkrechte keine Schädigung verursachen./ spray-water with an inclination up to 60° to the vertical axis must not cause any damage
IP X4	Schutz gegen Spritzwasser/ protection against splash-water	Spritzwasser aus beliebiger Richtung darf keine Schädigung verursachen/ splash-water from any direction must not cause any damages
IP X5	Schutz gegen Strahlwasser/ protection against jetting water	Strahlwasser aus einer Düse aus beliebiger Richtung darf keine Schädigung verursachen./ Jet-water out of a nozzle from any direction must not cause and damages
IP X6	Schutz gegen schwere See/ protection against heavy sea	Schwere See oder Strahlwasser unter hohem Druck dürfen nicht in gefahrbringender Menge in das Gehäuse eindringen./ Heavy seas or water jets under high pressure must not enter the enclosure in dangerous quantities.
IP X7	Schutz gegen das Eintauchen (t)/ protection against immersion in water	Eindringen von Wasser in gefahrbringender Menge dürfen beim Eintauchen in Wasser unter vorgegebenen Bedingungen hinsichtlich Druck und Zeit nicht stattfinden./ Ingress of water in hazardous quantities must not occur during immersion in water under specified conditions of pressure and time.
IP X8	Schutz gegen Untertauchen (t ...m)/ protection against submersion in water	Das Gerät ist unter Bedingungen, die vom Hersteller genannt werden, für Dauerbetrieb unter Wasser geeignet. Anmerkung: Üblicherweise bedeutet dies, dass das Gerät vollständig abgedichtet ist. Jedoch kann dies bei bestimmten Geräten auch bedeuten, das Wasser zwar eindringt, jedoch keine Schädigung verursacht./ Under conditions specified by the manufacturer, the appliance is suitable for continuous operation under water. Note: This usually means that the device is completely sealed. However, with certain appliances this can also mean that water penetrates but does not cause any damage.

TECNICO

Konzeption und Grafikdesign
Herbert Glaubacker und Steffen Bux, Molto Luce GmbH

Ein herzliches Danke gilt all unseren Partnern und Mitarbeitern, die uns bei der Realisierung dieses Kataloges unterstützt haben. Insbesondere auch jenen Firmen und Architekten, die uns aussagekräftige Projektfotos zur Verfügung gestellt haben. Sämtliche Inhalte in diesem Katalog entsprechen dem Stand bei Drucklegung und dienen ausschließlich zu Informationszwecken. Molto Luce behält sich das Recht vor, jederzeit und ohne Ankündigung die technischen Daten der im Katalog abgebildeten Produkte zu modifizieren. Für Farbabweichungen übernehmen wir keinerlei Haftung. Manche der im Katalog abgebildeten Produkte sind Bildretuschen und dienen zur Veranschaulichung der Einsatzmöglichkeiten. Mit dieser Bruttopreisliste in Schweizer Franken (exkl. MwSt.) gültig ab 1.05.2024 bis auf Widerruf verlieren alle bisherigen Preislisten Ihre Gültigkeit. Wir liefern ausschließlich nach unseren, Ihnen bekannten Liefer- und Verkaufsbedingungen. Die Ware bleibt bis zur vollständigen Bezahlung unser Eigentum. Preisänderung und Druckfehlerkorrektur vorbehalten. Unsere allgemeinen Geschäfts- und Lieferbedingungen können unter www.moltoluce.com eingesehen werden.

Conception and graphic design
Herbert Glaubacker and Steffen Bux, Molto Luce GmbH

Many thanks to all our partners and employees who have supported us in the realisation of this catalogue. In particular, we would also like to thank those companies and architects who have provided us with informative project photos. All content in this catalogue is correct at the time of going to press and is for information purposes only. Molto Luce reserves the right to modify the technical data of the products shown in the catalogue at any time and without prior notice. We accept no liability for colour deviations. Some of the products shown in the catalogue are retouched images and serve to illustrate the possible applications. With this gross price list in Swiss francs (excl. VAT) valid from 1 May 2024 until revoked, all previous price lists lose their validity. We deliver exclusively according to our terms and conditions of delivery and sale known to you. The goods remain our property until full payment has been received. We reserve the right to change prices and correct printing errors. Our general terms and conditions of business and delivery can be viewed at www.moltoluce.com.